

DATA SHEET

MULTILAYER CERAMIC CAPACITORS

CC Series
Y5V
10 V TO 50 V



SCOPE

This specification describes Yageo CC Y5V series chip capacitors.

ORDERING INFORMATION

Part number is identified by the series, size, tolerance, packing style, temperature coefficient, rated voltage and capacitance value.

CC xxxx x x **Y5V** x **BB** xxx
 (1) (2) (3) (4) (5)

(1) SIZE – INCH BASED (METRIC)

- 0402 (1005)
- 0603 (1608)
- 0805 (2012)
- 1206 (3216)

(2) TOLERANCE

- M = ±20%
- Z = -20/+80%

(3) PACKING STYLE

- R = 7" paper tape
- K = 7" blister tape
- P = 13" paper tape
- F = 13" blister tape
- C = Bulk case

(4) RATED VOLTAGE

- 6 = 10 V
- 7 = 16 V
- 8 = 25 V
- 9 = 50 V

(5) CAPACITANCE VALUE:

- First two for significant figures and 3rd for number of zero
- Letter "R" for decimal point

CONSTRUCTION

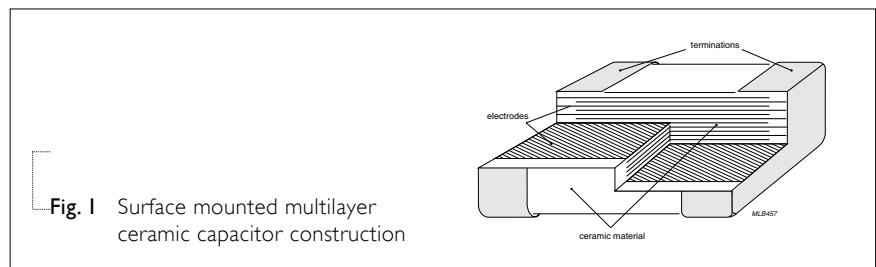

DIMENSION

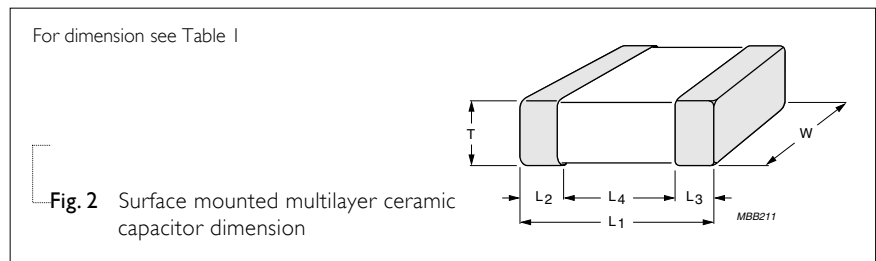

Table I

TYPE	0402	0603	0805	1206
L₁ (mm)	1.0 ±0.05	1.6 ±0.10	2.0 ±0.10	3.2 ±0.15
W (mm)	0.5 ±0.05	0.8 ±0.07	1.25 ±0.10	1.6 ±0.15
T (mm)	min. 0.45 max. 0.55	min. 0.73 max. 0.87	min. 0.50 max. 1.35	min. 0.50 max. 1.35
L₂/L₃ (mm)	min. 0.15 max. 0.30	min. 0.20 max. 0.60	min. 0.25 max. 0.75	min. 0.25 max. 0.75
L₄ (mm)	min. 0.40	0.40	0.55	1.40

CAPACITANCE RANGE & THICKNESS FOR 10V & 16V

Table 2

CAPACITANCE (nF)	10V			16V			
	0603	0805	1206	0402	0603	0805	1206
10							
22				0.5 ±0.05			
47							
100							
220					0.8 ±0.07		
470						0.85 ±0.1	
1,000	0.8 ±0.07	0.85 ±0.1					0.85 ±0.1
2,200							
4,700							1.15 ±0.1
10,000			1.15 ±0.1				

CAPACITANCE RANGE & THICKNESS FOR 25V & 50V

Table 3

CAPACITANCE (nF)	25V			50V		
	0603	0805	1206	0603	0805	1206
10						
22	0.8 ±0.07			0.8 ±0.07		
47					0.6 ±0.1	
100		0.6 ±0.1				
220			0.6 ±0.1		0.85 ±0.1	0.6 ±0.1
470		0.85 ±0.1	0.85 ±0.1			0.85 ±0.1
1,000			1.15 ±0.1			1.15 ±0.1

THICKNESS CLASSES AND PACKING QUANTITY

Table 4

THICKNESS CLASSIFICATION (mm)	8 mm TAPE WIDTH / AMOUNT PER REEL				AMOUNT PER BULK CASE		
	Ø180 mm, 7"		Ø330 mm, 13"		0402	0603	0805
	Paper	Blister	Paper	Blister			
0.5 ±0.05	10,000	---	50,000	---	50,000	---	---
0.6 ±0.10	4,000	---	20,000	---	---	---	10,000
0.8 ±0.07	4,000	---	15,000	---	---	15,000	---
0.85 ±0.10	4,000	---	15,000	---	---	---	8,000
1.15 ±0.10	---	3,000	---	10,000	---	---	---
1.25 ±0.10	---	3,000	---	10,000	---	---	5,000

ELECTRICAL CHARACTERISTICS

Table 5

CHARACTERISTICS	TEST CONDITIONS	REQUIREMENT
Operation temperature range	---	-30 °C to +85 °C
Temperature characteristic/coefficient (TC)	With respect to 25 °C within operation temperature range	+22% to -82%
Capacitance tolerance	1 Vrms/1KHz at 25 °C	±20%, -20%~+80%
Dissipation factor (D.F.)	1 Vrms/1KHz at 25 °C	See table 6
Insulation resistance (IR)	At U_r (rated voltage) for 1 minute	$R_{ins} \geq 10 \text{ G}\Omega$ or $R_{ins} \times C \geq 100$ seconds whichever is less
Dielectric withstanding Voltage	At $2.5 \times U_r$ for 5 seconds	No breakdown

Table 6 D.F. specification for 0402 to 1206 sizes

DISSIPATION FACTOR (D.F.)	RATED VOLTAGE (U_r)	CAPACITANCE VALUE OF SIZES			
		0402	0603	0805	1206
≤ 5%	25 V	---	< 100 nF	≤ 270 nF	< 1 μF
	50 V	---	< 100 nF	≤ 270 nF	< 1 μF
≤ 7%	25 V	---	≥ 100 nF	270 nF < Cap. Range < 470 nF	≥ 1 μF
	50 V	---	≥ 100 nF	> 270 nF	≥ 1 μF
≤ 9%	10 V	---	≤ 270 nF	≤ 1 μF	≤ 2.2μF
	16 V	---	≤ 270 nF	≤ 1 μF	≤ 2.2μF
	25 V	---	---	≥ 470 nF	---
≤ 12.5%	10 V	all	> 270 nF	> 1 μF	> 2.2μF
	16 V	all	> 270 nF	> 1 μF	> 2.2μF

TAPING REEL

Table 7

TAPE WIDE	8 mm	8 mm	12 mm
ØA (mm)	180	330	180
ØB (mm)	62±1.5	62±1.5	62±1.5
ØD (mm)	20.5	20.5	20.5
ØC (mm)	12.75±0.15/-0	12.75±0.15/-0	12.75±0.15/-0
W (mm)	8.4±1.5/-0	8.4±1.5/-0	12.4±2/-0
T _{max} (mm)	14.4	14.4	18.4

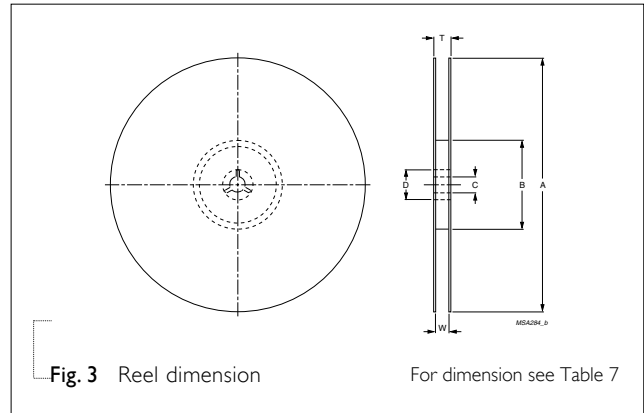

PAPER TAPE SPECIFICATION

Table 8

DIMENSION	0402	0603	0805	1206
A (mm)	0.62±0.05	1.10±0.05	1.65±0.05	2.0±0.1
B (mm)	1.12±0.05	1.90±0.05	2.4±0.05	3.5±0.1
W (mm)	8.0±0.2	8.0±0.2	8.0±0.2	8.0±0.2
E (mm)	1.75±0.1	1.75±0.1	1.75±0.1	1.75±0.1
F (mm)	3.5±0.05	3.5±0.05	3.5±0.05	3.5±0.05
P ₀ (mm)	4±0.05	4±0.05	4±0.05	4±0.05
P ₁ (mm)	2±0.05	4±0.1	4±0.1	4±0.1
P ₂ (mm)	2±0.05	2±0.05	2±0.05	2±0.05
ØD ₀ (mm)	1.5±0.1	1.5±0.1	1.5±0.1/-0	1.5±0.1/-0
T (mm)	0.6±0.05	0.95±0.05	0.95±0.05	0.95±0.05

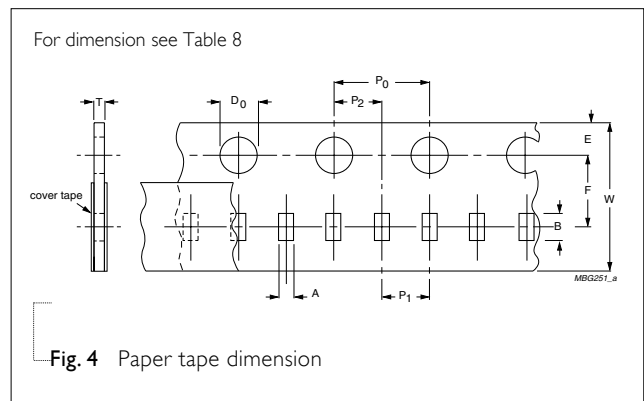

BLISTER TAPE SPECIFICATION

Table 9

DIMENSION	0805	1206	1210	1812
A (mm)	0.20	0.30	0.30	0.40
B (mm)	0.20	0.30	0.30	0.40
W (mm)	8.1±0.2	8.1±0.2	8.1±0.2	12.0±0.2
E (mm)	1.75±0.1	1.75±0.1	1.75±0.1	1.75±0.1
F (mm)	3.5±0.05	3.5±0.05	3.5±0.05	5.5±0.05
P ₀ (mm)	4±0.1	4±0.1	4±0.1	4±0.1
P ₁ (mm)	4±0.1	4±0.1	4±0.1	8±0.1
P ₂ (mm)	2±0.05	2±0.05	2±0.05	2±0.05
ØD ₀ (mm)	1.5±0.1/-0	1.5±0.1/-0	1.5±0.1/-0	1.5±0.1/-0
T _{max} (mm)	3.5	3.5	3.5	3.5

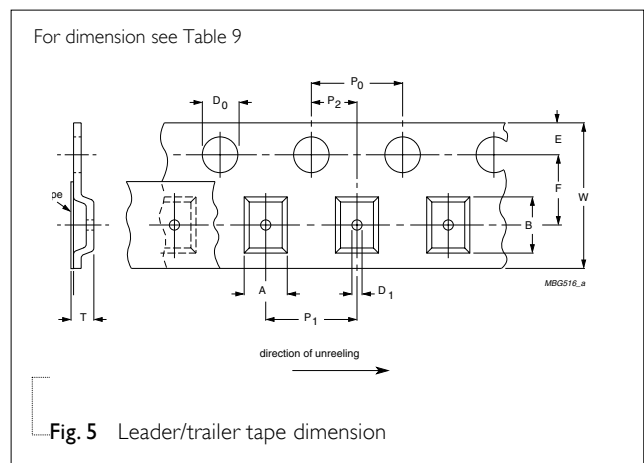

PACKING METHOD

LEADER/TRAILER TAPE SPECIFICATION

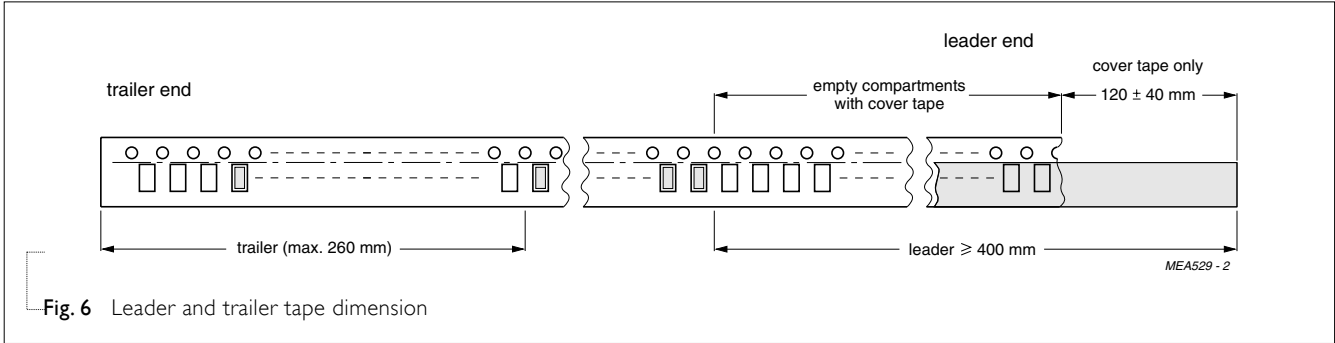

METHOD OF MOUNTING

For normal use the capacitors may be mounted on printed-circuit boards or ceramic substrates by applying wave soldering, reflow soldering (including vapor phase soldering) or conductive adhesive in accordance with CECC 00802 classification A.

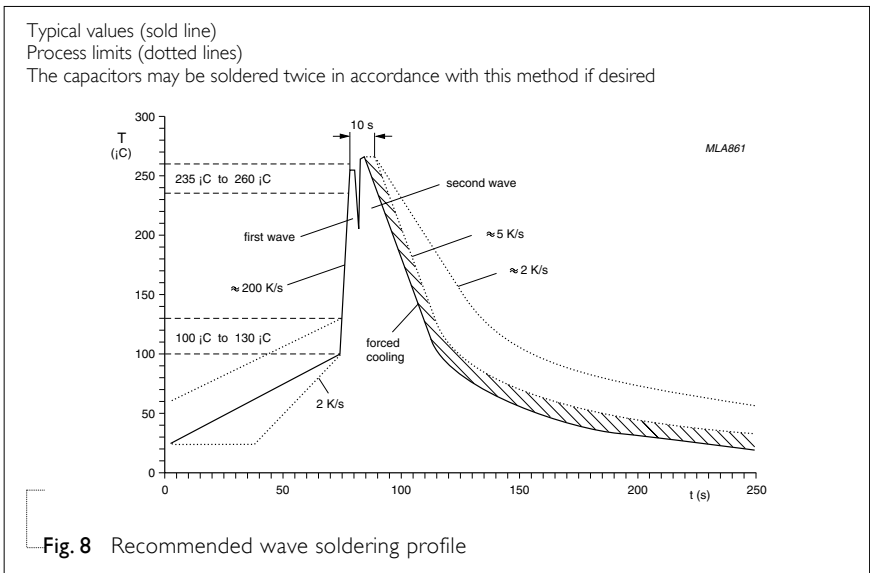
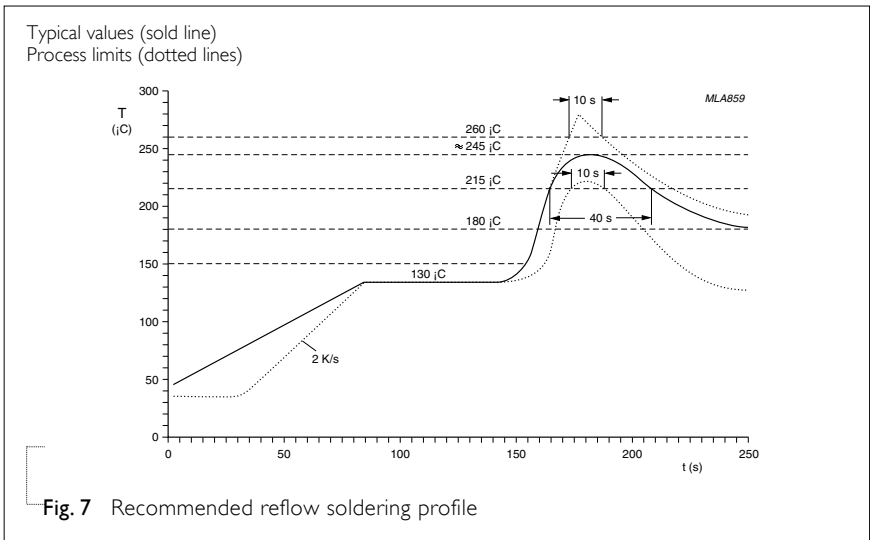

TEST AND REQUIREMENT

Table 10

IEC384-10	TEST ITEMS	CONDITIONS	REQUIREMENTS
4.9	Bending	Bending rate 1 mm/s, jig. radius 340 mm	$ \Delta C/C \leq 20\%$
4.10	Resistance to soldering heat	260±5 °C for 10±0.5 s in static solder bath	$-10\% \leq \Delta C/C \leq 20\%$
4.11	Solderability	235±5 °C for 2±0.5 s in a static solder bath	The termination shall be well tinned
4.12	Rapid change of temperature	Y5V: -30 °C to +85 °C, 5 cycles	$ \Delta C/C \leq 20\%$
4.14	Damp heat	Preconditioning At 40 °C, 90 to 95% RH and U_r applied for 500 hours	$ \Delta C/C $ within ±30% or -40% to +30% D.F. ≤ 7%, 12.5%, 15% (depending on capacitance value) $IR \geq 500 M\Omega$ or $R \times C \geq 25$ s whichever is less
4.15	Endurance	Preconditioning $2 \times U_r$ applied for 1,000 hours, at upper category temperature	D.F. ≤ 7%, 12.5%, 15% (depending on capacitance value) $IR \geq 1,000 M\Omega$ or $R \times C \geq 50$ s whichever is less

REVISION HISTORY

REVISION	DATE	CHANGE NOTIFICATION	DESCRIPTION
Version 9	June 24, 2005	-	- Revised thickness of Y5V 1206 16 V 4.7 μ F to 10 μ F
Version 8	Jan 14, 2005	-	- Revised thickness of Y5V 0805 16/25 V 1 μ F
Version 7	Aug 16, 2004	-	- D.F. value added
Version 6	Mar 12, 2004	-	- Thickness and packing quantity amending
Version 5	Aug. 13, 2003	-	- Taping drawing amended