

KEMET Part Number: C315C331J1G5TA
(C315C331J1G5TABULK)

Capacitor, ceramic, 330 pF, +/-5% Tol, 100 V, COG, Lead Spacing=0.1"

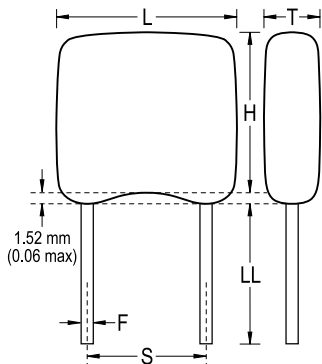

Dimensions (mm)

Symbol	Dimension	Tolerance
L	3.81	MAX
H	3.14	MAX
T	2.54	MAX
S	2.54	NOM
LL	7	MIN
F	0.51	NOM

Packaging Specifications

Package Kind:	Bulk
Package Type:	Bag
Package Quantity:	500

General Information

Supplier:	KEMET
Application:	General Purpose
Temperature Coefficient:	COG
Body Type:	Radial Conformal
Lead Type:	Wire Leads
Termination Type:	Tin (Sn)
RoHS:	Yes

Specifications

Capacitance:	330 pF
Voltage:	100 V
Tolerance:	+/-5%
Temperature Range:	-55/+125C
Failure Rate:	N/A
Dissipation Factor:	0.1%
Insulation Resistance:	100 GOhm
Dielectric Strength:	250 V