

KEMET Part Number: C315C104M5U5TA
(C315C104M5U5TABULK)

Capacitor, ceramic, 0.1 uF, +/-20% Tol, 50 V, Z5U, Lead Spacing=0.1"

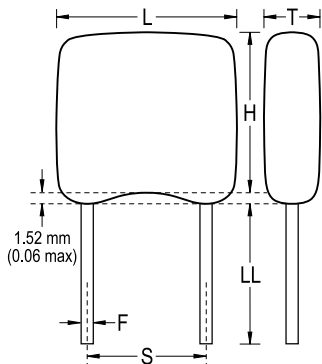

Dimensions (mm)

Symbol	Dimension	Tolerance
L	3.81	MAX
H	3.14	MAX
T	2.54	MAX
S	2.54	NOM
LL	7	MIN
F	0.51	NOM

Packaging Specifications

Package Kind:	Bulk
Package Type:	Bag
Package Quantity:	500

General Information

Supplier:	KEMET
Application:	General Purpose
Temperature Coefficient:	Z5U
Body Type:	Radial Conformal
Lead Type:	Wire Leads
Termination Type:	Tin (Sn)
RoHS:	Yes

Specifications

Capacitance:	0.1 uF
Voltage:	50 V
Tolerance:	+/-20%
Temperature Range:	+10/+85C
Failure Rate:	N/A
Dissipation Factor:	4%
Insulation Resistance:	1 GOhm
Dielectric Strength:	125 V