

SPECIFICATION

SPEC. No. 12a

D A T E : 2012 Nov.

To

CUSTOMER'S PRODUCT NAME

TDK PRODUCT NAME

MULTILAYER CERAMIC CHIP CAPACITORS
C0402, C0603, C1005, C1608, C2012, C3216,
C3225, C4532, C5750 Type

4V to 630V

CH C0G JB X5R X6S X7R X7S X7T Series

Please return this specification to TDK representatives.

If orders are placed without returned specification, please allow us to judge that specification is accepted by your side.

RECEIPT CONFIRMATION

DATE: YEAR MONTH DAY

TDK Corporation
Sales
Electronic Components
Sales & Marketing Group

TDK-EPC Corporation
Engineering
Ceramic Capacitors Business Group

APPROVED	Person in charge

APPROVED	CHECKED	Person in charge

1. SCOPE

This specification is applicable to chip type multilayer ceramic capacitors with a priority over the other relevant specifications.

Production places defined in this specification shall be TDK-EPC Corporation Japan, TDK (Suzhou) Co., Ltd and TDK Components U.S.A. Inc.

EXPLANATORY NOTE:

This specification warrants the quality of the ceramic chip capacitors. The chips should be evaluated or confirmed a state of mounted on your product.

If the use of the chips goes beyond the bounds of the specification, we can not afford to guarantee.

2. CODE CONSTRUCTION

(Example) C2012 X7R 1E 105 K T
 (1) (2) (3) (4) (5) (6)

(1) Type

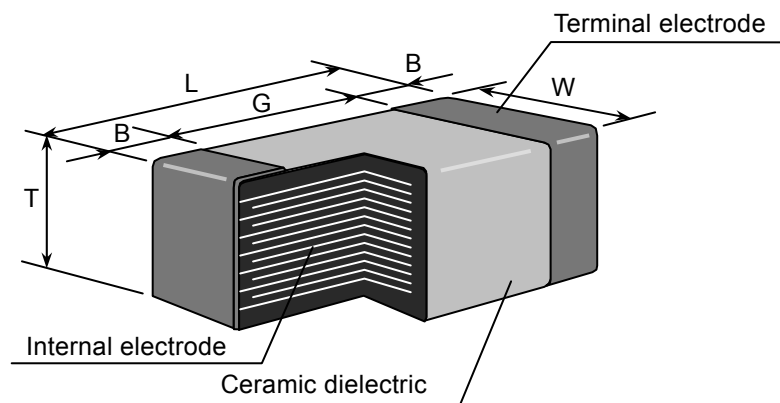

Please refer to product list for the dimension of each product.

(2) Temperature Characteristics (Details are shown in table 1 No.7 and No.8 at page 5)

(3) Rated Voltage

Symbol	Rated Voltage
2 J	DC 630 V
2 W	DC 450 V
2 V	DC 350 V
2 E	DC 250 V
2 A	DC 100 V
1 H	DC 50 V
1 V	DC 35 V
1 E	DC 25 V
1 C	DC 16 V
1 A	DC 10 V
0 J	DC 6.3 V
0 G	DC 4 V

(4) Rated Capacitance

Stated in three digits and in units of pico farads (pF).

The first and Second digits identify the first and second significant figures of the capacitance, the third digit identifies the multiplier.

R is designated for a decimal point.

Example 2R2 → 2.2pF

105 → 1,000,000pF

(5) Capacitance tolerance

Symbol	Tolerance	Capacitance
B	± 0.1 pF	10pF and under
C	± 0.25 pF	
D	± 0.5 pF	
J	± 5 %	Over 10pF
K	± 10 %	
M	± 20 %	

(6) Packaging

Symbol	Packaging
B	Bulk
T	Taping

3. RATED CAPACITANCE AND CAPACITANCE TOLERANCE

3.1 Standard combination of rated capacitance and tolerances

Class	Temperature Characteristics	Capacitance tolerance		Rated capacitance
1	C H C0G	10pF and under	B (± 0.1 pF) C (± 0.25 pF)	0.5, 1, 1.5, 2, 2.2, 3, 3.3, 4, 4.7, 5
			D (± 0.5 pF)	6, 6.8, 7, 8, 9, 10
		12pF to 10,000pF	J (± 5 %) K (± 10 %)	E – 12 series
		Over 10,000pF		E – 6 series
2	J B X5R X6S X7R X7S X7T	10uF and under	K (± 10 %) M (± 20 %)	E – 6 series
		Over 10uF	M (± 20 %)	

3.2 Capacitance Step in E series

E series	Capacitance Step											
E-3	1.0				2.2				4.7			
E-6	1.0	1.5	2.2	3.3	4.7	6.8						
E-12	1.0	1.2	1.5	1.8	2.2	2.7	3.3	3.9	4.7	5.6	6.8	8.2

4. OPERATING TEMPERATURE RANGE

T.C.	Min. operating Temperature	Max. operating Temperature	Reference Temperature
C H J B	-25°C	85°C	20°C
X5R	-55°C	85°C	25°C
X6S	-55°C	105°C	25°C
X7R X7S X7T C0G	-55°C	125°C	25°C

5. STORING CONDITION AND TERM

5 to 40°C at 20 to 70%RH
6 months Max.

6. P.C. BOARD

When mounting on an aluminum substrate, large case sizes such as C3225, C4532 and C5750 types are more likely to be affected by heat stress from the substrate.
Please inquire separate specification for the large case sizes when mounted on the substrate.

7. INDUSTRIAL WASTE DISPOSAL

Dispose this product as industrial waste in accordance with the Industrial Waste Law.

8. PERFORMANCE

table 1

No.	Item	Performance	Test or inspection method																		
1	External Appearance	No defects which may affect performance.	Inspect with magnifying glass (3×), in case of C0402 and C0603 type, with magnifying glass (10×)																		
2	Insulation Resistance	10,000MΩ or 500MΩ·μF min. (As for the capacitors of rated voltage 16, 10V DC and lower, 10,000 MΩ or 100MΩ·μF min.,) whichever smaller.	Apply rated voltage for 60s.																		
3	Voltage Proof	Withstand test voltage without insulation breakdown or other damage.	<table border="1"> <thead> <tr> <th>Class</th> <th>Rated voltage</th> <th>Apply voltage</th> </tr> </thead> <tbody> <tr> <td rowspan="2">Class1</td> <td>100V and under</td> <td>3 × rated voltage</td> </tr> <tr> <td>Over 100V</td> <td>1.5 × rated voltage</td> </tr> <tr> <td rowspan="2">Class2</td> <td>100V and under</td> <td>2.5 × rated voltage</td> </tr> <tr> <td>Over 100V</td> <td>1.5 × rated voltage</td> </tr> </tbody> </table> <p>Above DC voltage shall be applied for 1 to 5s. Charge / discharge current shall not exceed 50mA.</p>	Class	Rated voltage	Apply voltage	Class1	100V and under	3 × rated voltage	Over 100V	1.5 × rated voltage	Class2	100V and under	2.5 × rated voltage	Over 100V	1.5 × rated voltage					
Class	Rated voltage	Apply voltage																			
Class1	100V and under	3 × rated voltage																			
	Over 100V	1.5 × rated voltage																			
Class2	100V and under	2.5 × rated voltage																			
	Over 100V	1.5 × rated voltage																			
4	Capacitance	Within the specified tolerance.	<table border="1"> <thead> <tr> <th>Class</th> <th>Rated Capacitance</th> <th>Measuring frequency</th> <th>Measuring voltage</th> </tr> </thead> <tbody> <tr> <td rowspan="2">Class1</td> <td>1000pF and under</td> <td>1MHz±10%</td> <td rowspan="2">0.5-5Vrms.</td> </tr> <tr> <td>Over 1000pF</td> <td>1kHz±10%</td> </tr> <tr> <td rowspan="3">Class2</td> <td rowspan="2">10uF and under</td> <td rowspan="2">1kHz±10%</td> <td>0.5±0.2Vrms.</td> </tr> <tr> <td>1.0±0.2Vrms.</td> </tr> <tr> <td>Over 10uF</td> <td>120Hz±20%</td> <td>0.5±0.2Vrms.</td> </tr> </tbody> </table> <p>For information which product has which measuring voltage, please contact with our sales representative.</p>	Class	Rated Capacitance	Measuring frequency	Measuring voltage	Class1	1000pF and under	1MHz±10%	0.5-5Vrms.	Over 1000pF	1kHz±10%	Class2	10uF and under	1kHz±10%	0.5±0.2Vrms.	1.0±0.2Vrms.	Over 10uF	120Hz±20%	0.5±0.2Vrms.
Class	Rated Capacitance	Measuring frequency	Measuring voltage																		
Class1	1000pF and under	1MHz±10%	0.5-5Vrms.																		
	Over 1000pF	1kHz±10%																			
Class2	10uF and under	1kHz±10%	0.5±0.2Vrms.																		
			1.0±0.2Vrms.																		
	Over 10uF	120Hz±20%	0.5±0.2Vrms.																		
5	Q (Class1)	<table border="1"> <thead> <tr> <th>Rated Capacitance</th> <th>Q</th> </tr> </thead> <tbody> <tr> <td>30pF and over</td> <td>1,000 min.</td> </tr> <tr> <td>Under 30pF</td> <td>400+20×C min.</td> </tr> </tbody> </table> <p>C : Rated capacitance (pF)</p>	Rated Capacitance	Q	30pF and over	1,000 min.	Under 30pF	400+20×C min.	See No.4 in this table for measuring condition.												
Rated Capacitance	Q																				
30pF and over	1,000 min.																				
Under 30pF	400+20×C min.																				
6	Dissipation Factor (Class2)	<table border="1"> <thead> <tr> <th>T.C.</th> <th>D.F.</th> </tr> </thead> <tbody> <tr> <td>J B</td> <td>0.025 max.</td> </tr> <tr> <td>X5R</td> <td>0.03 max.</td> </tr> <tr> <td>X6S</td> <td>0.05 max.</td> </tr> <tr> <td>X7R</td> <td>0.075 max.</td> </tr> <tr> <td>X7S</td> <td>0.10 max.</td> </tr> <tr> <td>X7T</td> <td>0.15 max.</td> </tr> </tbody> </table>	T.C.	D.F.	J B	0.025 max.	X5R	0.03 max.	X6S	0.05 max.	X7R	0.075 max.	X7S	0.10 max.	X7T	0.15 max.	See No.4 in this table for measuring condition. For information which product has which Dissipation Factor, please contact with our sales representative.				
T.C.	D.F.																				
J B	0.025 max.																				
X5R	0.03 max.																				
X6S	0.05 max.																				
X7R	0.075 max.																				
X7S	0.10 max.																				
X7T	0.15 max.																				

(continued)

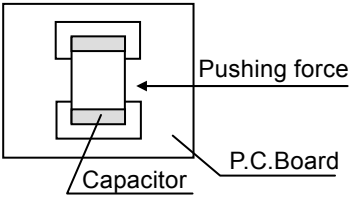
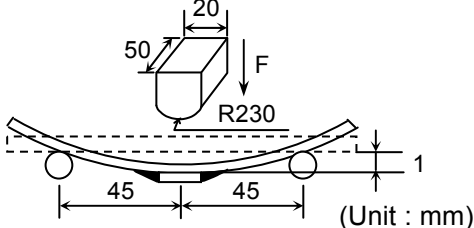
No.	Item	Performance	Test or inspection method																												
7	Temperature Characteristics of Capacitance (Class1)	<table border="1" data-bbox="518 235 900 383"> <thead> <tr> <th>T.C.</th> <th>Temperature Coefficient (ppm/°C)</th> </tr> </thead> <tbody> <tr> <td>C H</td> <td>0 ± 60</td> </tr> <tr> <td>C0G</td> <td>0 ± 30</td> </tr> </tbody> </table> <p>Capacitance drift Within ± 0.2% or ±0.05pF, whichever larger.</p>	T.C.	Temperature Coefficient (ppm/°C)	C H	0 ± 60	C0G	0 ± 30	<p>Temperature coefficient shall be calculated based on values at 25°C and 85°C temperature.</p> <p>Measuring temperature below 20°C shall be -10°C and -25°C.</p>																						
T.C.	Temperature Coefficient (ppm/°C)																														
C H	0 ± 60																														
C0G	0 ± 30																														
8	Temperature Characteristics of Capacitance (Class2)	<table border="1" data-bbox="518 533 900 1128"> <thead> <tr> <th colspan="2">Capacitance Change (%)</th> </tr> <tr> <th>No voltage applied</th> <th>With voltage applied</th> </tr> </thead> <tbody> <tr> <td>J B : ±10</td> <td>J B : + 10 - 30 : + 10 - 50 : + 10 - 60 : —</td> </tr> <tr> <td>X5R : ±15</td> <td>—</td> </tr> <tr> <td>X6S : ±22</td> <td>—</td> </tr> <tr> <td>X7R : ±15</td> <td>—</td> </tr> <tr> <td>X7S : ±22</td> <td>—</td> </tr> <tr> <td>X7T : +22</td> <td>—</td> </tr> <tr> <td>-33</td> <td>—</td> </tr> </tbody> </table>	Capacitance Change (%)		No voltage applied	With voltage applied	J B : ±10	J B : + 10 - 30 : + 10 - 50 : + 10 - 60 : —	X5R : ±15	—	X6S : ±22	—	X7R : ±15	—	X7S : ±22	—	X7T : +22	—	-33	—	<p>Capacitance shall be measured by the steps shown in the following table after thermal equilibrium is obtained for each step.</p> <p>ΔC be calculated ref. STEP3 reading</p> <table border="1" data-bbox="970 712 1406 972"> <thead> <tr> <th>Step</th> <th>Temperature(°C)</th> </tr> </thead> <tbody> <tr> <td>1</td> <td>Reference temp. ± 2</td> </tr> <tr> <td>2</td> <td>Min. operating temp. ± 2</td> </tr> <tr> <td>3</td> <td>Reference temp. ± 2</td> </tr> <tr> <td>4</td> <td>Max. operating temp. ± 2</td> </tr> </tbody> </table> <p>Measuring voltage: 0.1, 0.2, 0.5, 1.0Vrms. For information which product has which applied voltage, please contact with our sales representative.</p>	Step	Temperature(°C)	1	Reference temp. ± 2	2	Min. operating temp. ± 2	3	Reference temp. ± 2	4	Max. operating temp. ± 2
Capacitance Change (%)																															
No voltage applied	With voltage applied																														
J B : ±10	J B : + 10 - 30 : + 10 - 50 : + 10 - 60 : —																														
X5R : ±15	—																														
X6S : ±22	—																														
X7R : ±15	—																														
X7S : ±22	—																														
X7T : +22	—																														
-33	—																														
Step	Temperature(°C)																														
1	Reference temp. ± 2																														
2	Min. operating temp. ± 2																														
3	Reference temp. ± 2																														
4	Max. operating temp. ± 2																														
9	Robustness of Terminations	No sign of termination coming off, breakage of ceramic, or other abnormal signs.	<p>Reflow solder the capacitors on a P.C.Board shown in Appendix 1a or Appendix 1b and apply a pushing force of 2N (C0603, C1005) or 5N (C1608, C2012, C3216, C3225, C4532, C5750) with 10±1s. (Not applicable to C0402.)</p> 																												
10	Bending	No mechanical damage.	<p>Reflow solder the capacitors on a P.C.Board shown in Appendix 2a or Appendix 2b and bend it for 1mm.</p>  <p>(Unit : mm)</p>																												

(continued)

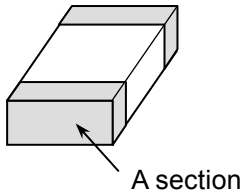
No.	Item	Performance	Test or inspection method
11	Solderability	<p>(C0402)</p> <p>Both end faces and the contact areas shall be covered with a smooth and bright solder coating with no more than a small amount of scattered imperfections such as pinholes or un-wetted or de-wetted areas. These imperfections shall not be concentrated in one area.</p> <p>(Others)</p> <p>New solder to cover over 75% of termination. 25% may have pin holes or rough spots but not concentrated in one spot. Ceramic surface of A sections shall not be exposed due to melting or shifting of termination material.</p> 	<p>Completely soak both terminations in solder at $235\pm 5^{\circ}\text{C}$ for $2 \pm 0.5\text{s}$.</p> <p>Solder : H63A (JIS Z 3282)</p> <p>Flux: Isopropyl alcohol (JIS K 8839) Rosin (JIS K 5902) 25% solid solution.</p> <p>Only reflow soldering applicable to C0402.</p> <p>Peak condition Temp. : $235\pm 5^{\circ}\text{C}$ Time: $2\pm 0.5\text{s}$.</p> <p>Preheating condition Temp. : $150\pm 10^{\circ}\text{C}$ Time: 1 to 2min.</p>

(continued)

No.	Item	Performance	Test or inspection method																				
12	Resistance to solder heat	External appearance	No cracks are allowed and terminations shall be covered at least 60% with new solder.																				
		Capacitance	<table border="1"> <thead> <tr> <th colspan="2">Characteristics</th> <th>Change from the value before test</th> </tr> </thead> <tbody> <tr> <td>Class 1</td> <td>C H C0G</td> <td>Capacitance drift within $\pm 2.5\%$ or $\pm 0.25\text{pF}$, whichever larger.</td> </tr> <tr> <td rowspan="5">Class 2</td> <td>J B</td> <td>$\pm 7.5\%$</td> </tr> <tr> <td>X5R</td> <td>$\pm 7.5\%$</td> </tr> <tr> <td>X6S</td> <td>$\pm 7.5\%$</td> </tr> <tr> <td>X7R</td> <td>$\pm 7.5\%$</td> </tr> <tr> <td>X7S</td> <td>$\pm 7.5\%$</td> </tr> <tr> <td>X7T</td> <td>$\pm 7.5\%$</td> </tr> </tbody> </table>	Characteristics		Change from the value before test	Class 1	C H C0G	Capacitance drift within $\pm 2.5\%$ or $\pm 0.25\text{pF}$, whichever larger.	Class 2	J B	$\pm 7.5\%$	X5R	$\pm 7.5\%$	X6S	$\pm 7.5\%$	X7R	$\pm 7.5\%$	X7S	$\pm 7.5\%$	X7T	$\pm 7.5\%$	<p>Completely soak both terminations in solder at $260\pm 5^\circ\text{C}$ for $5\pm 1\text{s}$.</p> <p>Preheating condition Temp. : $150\pm 10^\circ\text{C}$ Time: 1 to 2min.</p> <p>Solder : H63A (JIS Z 3282)</p> <p>Flux : Isopropyl alcohol (JIS K 8839) Rosin (JIS K 5902) 25% solid solution.</p> <p>Leave the capacitors in ambient condition for 6 to 24h (Class1) or $24\pm 2\text{h}$ (Class2) before measurement.</p> <p>Only reflow soldering applicable to C0402.</p> <p>Peak condition Temp. : $235\pm 5^\circ\text{C}$ Time: $2\pm 0.5\text{s}$.</p> <p>Preheating condition Temp. : $150\pm 10^\circ\text{C}$ Time : 1 to 2min.</p>
			Characteristics		Change from the value before test																		
		Class 1	C H C0G	Capacitance drift within $\pm 2.5\%$ or $\pm 0.25\text{pF}$, whichever larger.																			
		Class 2	J B	$\pm 7.5\%$																			
			X5R	$\pm 7.5\%$																			
			X6S	$\pm 7.5\%$																			
X7R	$\pm 7.5\%$																						
X7S	$\pm 7.5\%$																						
X7T	$\pm 7.5\%$																						
Q (Class1)	<table border="1"> <thead> <tr> <th>Rated Capacitance</th> <th>Q</th> </tr> </thead> <tbody> <tr> <td>30pF and over</td> <td>1,000 min.</td> </tr> <tr> <td>Under 30pF</td> <td>$400+20\times C$ min.</td> </tr> </tbody> </table> <p>C : Rated capacitance (pF)</p>	Rated Capacitance	Q	30pF and over	1,000 min.	Under 30pF	$400+20\times C$ min.																
Rated Capacitance	Q																						
30pF and over	1,000 min.																						
Under 30pF	$400+20\times C$ min.																						
D.F. (Class2)	Meet the initial spec.																						
Insulation Resistance	Meet the initial spec.																						
Voltage proof	No insulation breakdown or other damage.																						
13	Vibration	External appearance	No mechanical damage.																				
		Capacitance	<table border="1"> <thead> <tr> <th colspan="2">Characteristics</th> <th>Change from the value before test</th> </tr> </thead> <tbody> <tr> <td>Class1</td> <td>C H C0G</td> <td>$\pm 2.5\%$ or $\pm 0.25\text{pF}$, whichever larger.</td> </tr> <tr> <td rowspan="5">Class2</td> <td>J B</td> <td>$\pm 7.5\%$</td> </tr> <tr> <td>X5R</td> <td>$\pm 7.5\%$</td> </tr> <tr> <td>X6S</td> <td>$\pm 7.5\%$</td> </tr> <tr> <td>X7R</td> <td>$\pm 7.5\%$</td> </tr> <tr> <td>X7S</td> <td>$\pm 7.5\%$</td> </tr> <tr> <td>X7T</td> <td>$\pm 7.5\%$</td> </tr> </tbody> </table>	Characteristics		Change from the value before test	Class1	C H C0G	$\pm 2.5\%$ or $\pm 0.25\text{pF}$, whichever larger.	Class2	J B	$\pm 7.5\%$	X5R	$\pm 7.5\%$	X6S	$\pm 7.5\%$	X7R	$\pm 7.5\%$	X7S	$\pm 7.5\%$	X7T	$\pm 7.5\%$	<p>Reflow solder the capacitors on a P.C.Board shown in Appendix 1a or Appendix 1b before testing.</p> <p>Vibrate the capacitors with amplitude of 1.5mm P-P changing the frequencies from 10Hz to 55Hz and back to 10Hz in about 1min. Repeat this for 2h each in 3 perpendicular directions.</p>
			Characteristics		Change from the value before test																		
		Class1	C H C0G	$\pm 2.5\%$ or $\pm 0.25\text{pF}$, whichever larger.																			
Class2	J B	$\pm 7.5\%$																					
	X5R	$\pm 7.5\%$																					
	X6S	$\pm 7.5\%$																					
	X7R	$\pm 7.5\%$																					
	X7S	$\pm 7.5\%$																					
X7T	$\pm 7.5\%$																						
Q (Class1)	<table border="1"> <thead> <tr> <th>Rated Capacitance</th> <th>Q</th> </tr> </thead> <tbody> <tr> <td>30pF and over</td> <td>1,000 min.</td> </tr> <tr> <td>Under 30pF</td> <td>$400+20\times C$ min.</td> </tr> </tbody> </table> <p>C : Rated capacitance (pF)</p>	Rated Capacitance	Q	30pF and over	1,000 min.	Under 30pF	$400+20\times C$ min.																
Rated Capacitance	Q																						
30pF and over	1,000 min.																						
Under 30pF	$400+20\times C$ min.																						
D.F. (Class2)	Meet the initial spec.																						

(continued)

No.	Item		Performance	Test or inspection method															
14	Temperature cycle	External appearance	No mechanical damage.	<p>Reflow solder the capacitors on a P.C.Board shown in Appendix1a or Appendix1b before testing.</p> <p>Expose the capacitors in the condition step1 through step 4 and repeat 5 times consecutively.</p> <p>Leave the capacitors in ambient condition for 6 to 24h (Class 1) or 24±2h (Class 2) before measurement.</p> <table border="1"> <thead> <tr> <th>Step</th> <th>Temperature(°C)</th> <th>Time (min.)</th> </tr> </thead> <tbody> <tr> <td>1</td> <td>Min. operating temp. ± 3</td> <td>30 ± 3</td> </tr> <tr> <td>2</td> <td>Reference Temp.</td> <td>2 - 5</td> </tr> <tr> <td>3</td> <td>Max. operating temp. ± 2</td> <td>30 ± 2</td> </tr> <tr> <td>4</td> <td>Reference Temp.</td> <td>2 - 5</td> </tr> </tbody> </table>	Step	Temperature(°C)	Time (min.)	1	Min. operating temp. ± 3	30 ± 3	2	Reference Temp.	2 - 5	3	Max. operating temp. ± 2	30 ± 2	4	Reference Temp.	2 - 5
		Step	Temperature(°C)		Time (min.)														
		1	Min. operating temp. ± 3		30 ± 3														
		2	Reference Temp.		2 - 5														
		3	Max. operating temp. ± 2		30 ± 2														
		4	Reference Temp.		2 - 5														
Capacitance	<table border="1"> <thead> <tr> <th colspan="2">Characteristics</th> <th>Change from the value before test</th> </tr> </thead> <tbody> <tr> <td>Class1</td> <td>C H C0G</td> <td>±2.5% or ±0.25pF, whichever larger.</td> </tr> <tr> <td rowspan="5">*Class2</td> <td>J B</td> <td rowspan="5">± 7.5 %</td> </tr> <tr> <td>X5R</td> </tr> <tr> <td>X6S</td> </tr> <tr> <td>X7R</td> </tr> <tr> <td>X7S</td> </tr> <tr> <td>X7T</td> <td>± 12.5 %</td> </tr> </tbody> </table> <p>* Applied for some parts.</p>	Characteristics		Change from the value before test	Class1	C H C0G	±2.5% or ±0.25pF, whichever larger.	*Class2	J B	± 7.5 %	X5R	X6S	X7R	X7S	X7T	± 12.5 %			
Characteristics		Change from the value before test																	
Class1	C H C0G	±2.5% or ±0.25pF, whichever larger.																	
*Class2	J B	± 7.5 %																	
	X5R																		
	X6S																		
	X7R																		
	X7S																		
X7T	± 12.5 %																		
Q (Class1)	<table border="1"> <thead> <tr> <th>Rated Capacitance</th> <th>Q</th> </tr> </thead> <tbody> <tr> <td>30pF and over</td> <td>1,000 min.</td> </tr> <tr> <td>Under 30pF</td> <td>400+20×C min.</td> </tr> </tbody> </table> <p>C : Rated capacitance (pF)</p>	Rated Capacitance	Q	30pF and over	1,000 min.	Under 30pF	400+20×C min.												
Rated Capacitance	Q																		
30pF and over	1,000 min.																		
Under 30pF	400+20×C min.																		
D.F. (Class2)	Meet the initial spec.																		
Insulation Resistance	Meet the initial spec.																		
Voltage proof	No insulation breakdown or other damage.																		

(continued)

No.	Item		Performance		Test or inspection method								
15	Moisture Resistance (Steady State)	External appearance	No mechanical damage.		Reflow solder the capacitors on a P.C.Board shown in Appendix 1a or Appendix 1b before testing. Leave at temperature $40 \pm 2^{\circ}\text{C}$, 90 to 95%RH for 500 +24,0h. Leave the capacitors in ambient condition for 6 to 24h (Class1) or 24 ± 2 h (Class2) before measurement.								
		Capacitance	<table border="1" style="width:100%; border-collapse: collapse;"> <thead> <tr> <th colspan="2" style="text-align: left;">Characteristics</th> <th style="text-align: left;">Change from the value before test</th> </tr> </thead> <tbody> <tr> <td style="text-align: center;">Class1</td> <td style="text-align: center;">C H C0G</td> <td style="text-align: center;">$\pm 5\%$ or $\pm 0.5\text{pF}$, whichever larger.</td> </tr> <tr> <td style="text-align: center;">*Class2</td> <td style="text-align: center;">J B X5R X6S X7R X7S X7T</td> <td style="text-align: center;">$\pm 10\%$ $\pm 12.5\%$ $\pm 25\%$</td> </tr> </tbody> </table> <p>* Applied for some parts.</p>			Characteristics		Change from the value before test	Class1	C H C0G	$\pm 5\%$ or $\pm 0.5\text{pF}$, whichever larger.	*Class2	J B X5R X6S X7R X7S X7T
	Characteristics		Change from the value before test										
	Class1	C H C0G	$\pm 5\%$ or $\pm 0.5\text{pF}$, whichever larger.										
	*Class2	J B X5R X6S X7R X7S X7T	$\pm 10\%$ $\pm 12.5\%$ $\pm 25\%$										
Q (Class1)	<table border="1" style="width:100%; border-collapse: collapse;"> <thead> <tr> <th style="text-align: left;">Rated Capacitance</th> <th style="text-align: left;">Q</th> </tr> </thead> <tbody> <tr> <td style="text-align: center;">30pF and over</td> <td style="text-align: center;">350 min.</td> </tr> <tr> <td style="text-align: center;">10pF and over under 30pF</td> <td style="text-align: center;">$275+5/2 \times C$ min.</td> </tr> <tr> <td style="text-align: center;">Under 10pF</td> <td style="text-align: center;">$200+10 \times C$ min.</td> </tr> </tbody> </table> <p>C : Rated capacitance (pF)</p>		Rated Capacitance	Q	30pF and over	350 min.	10pF and over under 30pF	$275+5/2 \times C$ min.	Under 10pF	$200+10 \times C$ min.			
Rated Capacitance	Q												
30pF and over	350 min.												
10pF and over under 30pF	$275+5/2 \times C$ min.												
Under 10pF	$200+10 \times C$ min.												
D.F. (Class2)	200% of initial spec. max.												
Insulation Resistance	1,000M Ω or 50M Ω · μF min. (As for the capacitors of rated voltage 16, 10V DC and lower, 1,000 M Ω or 10M Ω · μF min.,) whichever smaller.												

(continued)

No.	Item		Performance	Test or inspection method									
16	Moisture Resistance	External appearance	No mechanical damage.	<p>Reflow solder the capacitors on a P.C.Board shown in Appendix1a or Appendix 1b before testing.</p> <p>Apply the rated voltage at temperature $40\pm 2^{\circ}\text{C}$ and 90 to 95%RH for 500 +24,0h.</p> <p>Charge/discharge current shall not exceed 50mA.</p> <p>Leave the capacitors in ambient condition for 6 to 24h (Class1) or 24±2h (Class2) before measurement.</p> <p>Voltage conditioning (only for class 2) Voltage treat the capacitors under testing temperature and voltage for 1 hour.</p> <p>Leave the capacitors in ambient condition for 24±2h before measurement.</p> <p>Use this measurement for initial value.</p>									
		Capacitance	<table border="1" data-bbox="549 376 957 701"> <thead> <tr> <th colspan="2" data-bbox="549 376 740 443">Characteristics</th> <th data-bbox="740 376 957 443">Change from the value before test</th> </tr> </thead> <tbody> <tr> <td data-bbox="549 443 655 521">Class1</td> <td data-bbox="655 443 740 521">C H C0G</td> <td data-bbox="740 443 957 521">$\pm 7.5\%$ or $\pm 0.75\text{pF}$, whichever larger.</td> </tr> <tr> <td data-bbox="549 521 655 701">*Class2</td> <td data-bbox="655 521 740 701">J B X5R X6S X7R X7S X7T</td> <td data-bbox="740 521 957 701">$\pm 10\%$ $\pm 12.5\%$ $\pm 25\%$</td> </tr> </tbody> </table> <p data-bbox="533 712 804 741">* Applied for some parts.</p>		Characteristics		Change from the value before test	Class1	C H C0G	$\pm 7.5\%$ or $\pm 0.75\text{pF}$, whichever larger.	*Class2	J B X5R X6S X7R X7S X7T	$\pm 10\%$ $\pm 12.5\%$ $\pm 25\%$
		Characteristics			Change from the value before test								
		Class1	C H C0G		$\pm 7.5\%$ or $\pm 0.75\text{pF}$, whichever larger.								
		*Class2	J B X5R X6S X7R X7S X7T		$\pm 10\%$ $\pm 12.5\%$ $\pm 25\%$								
Q (Class1)	<table border="1" data-bbox="549 790 957 925"> <thead> <tr> <th data-bbox="549 790 767 835">Rated Capacitance</th> <th data-bbox="767 790 957 835">Q</th> </tr> </thead> <tbody> <tr> <td data-bbox="549 835 767 880">30pF and over</td> <td data-bbox="767 835 957 880">200 min.</td> </tr> <tr> <td data-bbox="549 880 767 925">Under 30pF</td> <td data-bbox="767 880 957 925">$100+10/3\times C$ min.</td> </tr> </tbody> </table> <p data-bbox="533 936 863 965">C : Rated capacitance (pF)</p>	Rated Capacitance	Q	30pF and over	200 min.	Under 30pF	$100+10/3\times C$ min.						
Rated Capacitance	Q												
30pF and over	200 min.												
Under 30pF	$100+10/3\times C$ min.												
D.F. (Class2)	200% of initial spec. max.												
Insulation Resistance	500MΩ or 25MΩ·μF min. (As for the capacitors of rated voltage 16, 10V DC and lower, 500 MΩ or 5MΩ·μF min.,) whichever smaller.												

(continued)

No.	Item		Performance	Test or inspection method																
17	Life	External appearance	No mechanical damage.	Reflow solder the capacitors on a P.C.Board shown in Appendix1a or Appendix 1b before testing. Below the voltage shall be applied at maximum operating temperature $\pm 2^{\circ}\text{C}$ for 1,000 +48, 0h. <hr/> Applied voltage <hr/> Rated voltage x2 <hr/> Rated voltage x1.5 <hr/> Rated voltage x1.2 <hr/> Rated voltage x1 <hr/> For information which product has which applied voltage, please contact with our sales representative. Charge/discharge current shall not exceed 50mA. Leave the capacitors in ambient condition for 6 to 24h (Class1) or 24 \pm 2h (Class2) before measurement. Voltage conditioning (only for class 2) Voltage treat the capacitors under testing temperature and voltage for 1 hour. Leave the capacitors in ambient condition for 24 \pm 2h before measurement. Use this measurement for initial value.																
		Capacitance	<table border="1"> <thead> <tr> <th colspan="2">Characteristics</th> <th>Change from the value before test</th> </tr> </thead> <tbody> <tr> <td>Class1</td> <td>C H C0G</td> <td>$\pm 3\%$ or $\pm 0.3\text{pF}$, whichever larger.</td> </tr> <tr> <td rowspan="5">*Class2</td> <td>J B</td> <td rowspan="5">$\pm 10\%$</td> </tr> <tr> <td>X5R</td> </tr> <tr> <td>X6S</td> </tr> <tr> <td>X7R</td> </tr> <tr> <td>X7S</td> </tr> <tr> <td>X7T</td> <td>$\pm 25\%$</td> </tr> </tbody> </table>		Characteristics		Change from the value before test	Class1	C H C0G	$\pm 3\%$ or $\pm 0.3\text{pF}$, whichever larger.	*Class2	J B	$\pm 10\%$	X5R	X6S	X7R	X7S	X7T	$\pm 25\%$	
			Characteristics		Change from the value before test															
			Class1		C H C0G	$\pm 3\%$ or $\pm 0.3\text{pF}$, whichever larger.														
		*Class2	J B		$\pm 10\%$															
X5R																				
X6S																				
X7R																				
X7S																				
X7T	$\pm 25\%$																			
* Applied for some parts.																				
Q (Class1)	<table border="1"> <thead> <tr> <th>Rated Capacitance</th> <th>Q</th> </tr> </thead> <tbody> <tr> <td>30pF and over</td> <td>350 min.</td> </tr> <tr> <td>10pF and over under 30pF</td> <td>$275+5/2 \times C$ min.</td> </tr> <tr> <td>Under 10pF</td> <td>$200+10 \times C$ min.</td> </tr> </tbody> </table>	Rated Capacitance	Q	30pF and over	350 min.	10pF and over under 30pF	$275+5/2 \times C$ min.	Under 10pF	$200+10 \times C$ min.											
Rated Capacitance	Q																			
30pF and over	350 min.																			
10pF and over under 30pF	$275+5/2 \times C$ min.																			
Under 10pF	$200+10 \times C$ min.																			
D.F. (Class2)	200% of initial spec. max.																			
Insulation Resistance	1,000M Ω or 50M $\Omega \cdot \mu\text{F}$ min. (As for the capacitors of rated voltage 16, 10V DC and lower, 1,000 M Ω or 10M $\Omega \cdot \mu\text{F}$ min.,) whichever smaller.																			

*As for the initial measurement of capacitors (Class2) on number 8,12,13,14 and 15, leave capacitors at 150 -10,0 $^{\circ}\text{C}$ for 1 hour and measure the value after leaving capacitors for 24 \pm 2h in ambient condition.

Appendix - 1a

P.C. Board for reliability test

Applied for C0402, C0603, C1005, C1608, C2012, C3216

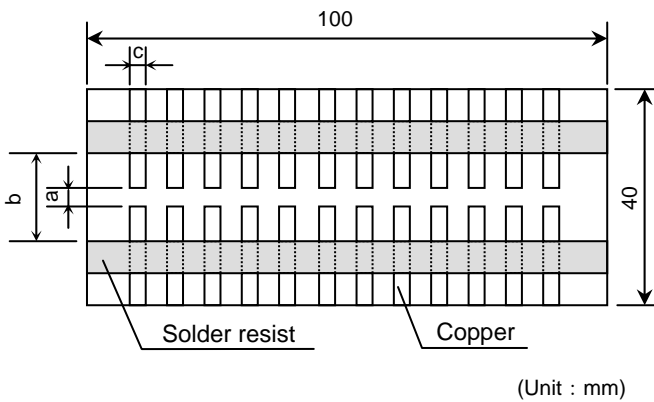

Appendix - 1b

P.C. Board for reliability test

Applied for C3225, C4532, C5750

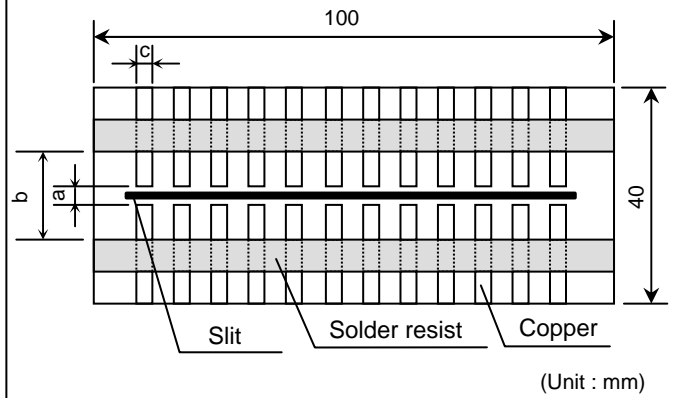

Appendix - 2a

P.C. Board for bending test

Applied for C0402, C0603, C1005

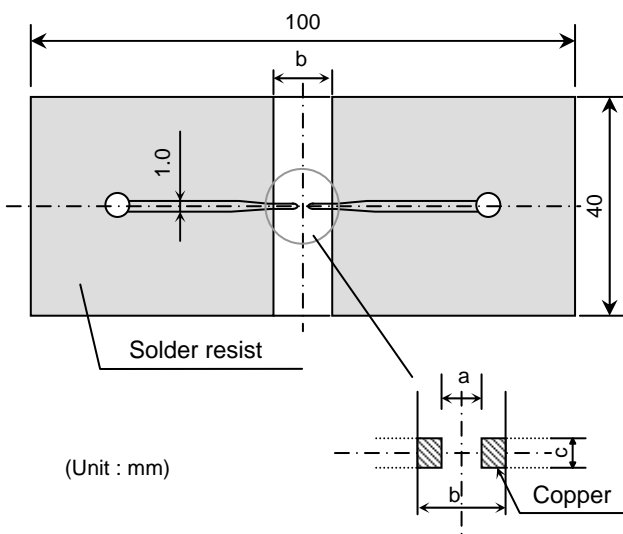

Appendix - 2b

P.C. Board for bending test

Applied for C1608, C2012, C3216, C3225, C4532, C5750

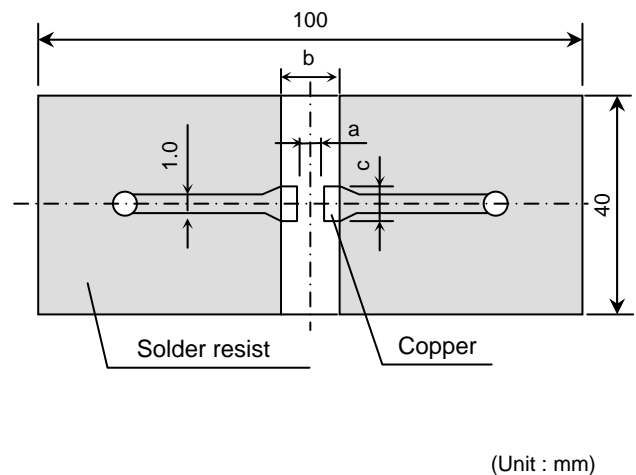

Material : Glass Epoxy (As per JIS C6484 GE4)

P.C. Board thickness : Appendix-2a 0.8mm
Appendix-1a, 1b, 2b 1.6mm

- Copper (thickness 0.035mm)
- Solder resist

TDK (EIA style)	Dimensions (mm)		
	a	b	c
C0402 (CC01005)	0.2	0.8	0.2
C0603 (CC0201)	0.3	0.8	0.3
C1005 (CC0402)	0.4	1.5	0.5
C1608 (CC0603)	1.0	3.0	1.2
C2012 (CC0805)	1.2	4.0	1.65
C3216 (CC1206)	2.2	5.0	2.0
C3225 (CC1210)	2.2	5.0	2.9
C4532 (CC1812)	3.5	7.0	3.7
C5750 (CC2220)	4.5	8.0	5.6

9. INSIDE STRUCTURE AND MATERIAL

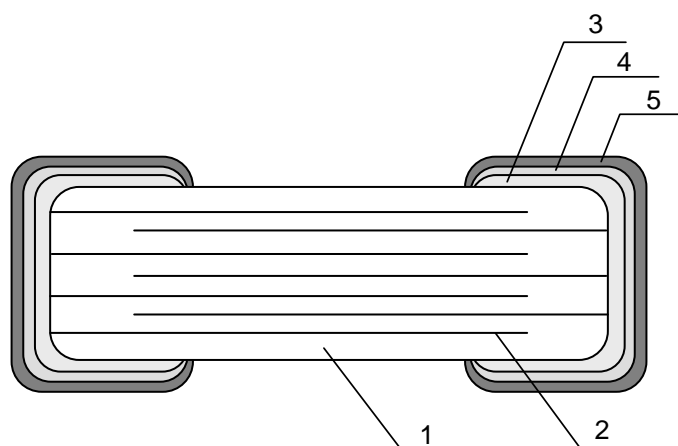

No.	NAME	MATERIAL	
		Class1	Class2
1	Dielectric	CaZrO ₃	BaTiO ₃
2	Electrode	Nickel (Ni)	
3	Termination	Copper (Cu)	
4		Nickel (Ni)	
5		Tin (Sn)	

10. RECOMMENDATION

As for C3225, C4532 and C5750 types, It is recommended to provide a slit (about 1mm wide) in the board under the components to improve washing Flux. And please make sure to dry detergent up completely before.

11. SOLDERING CONDITION

As for C0402, C0603, C1005, C3225, C4532 and C5750 types, reflow soldering only.

12. Caution

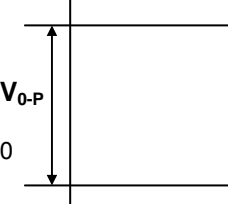
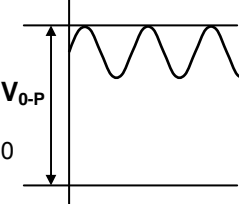
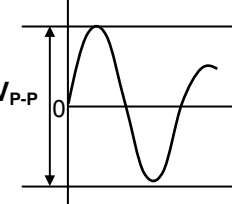
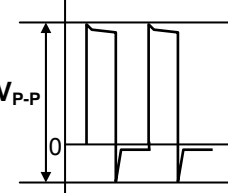
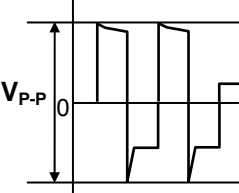
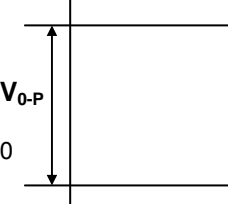
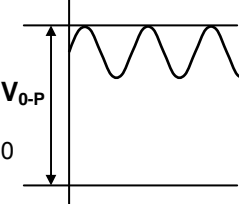
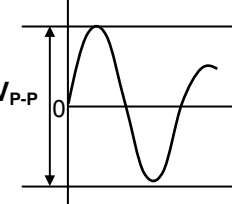
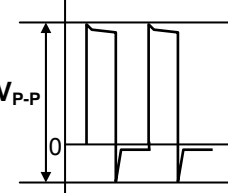
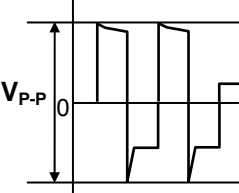
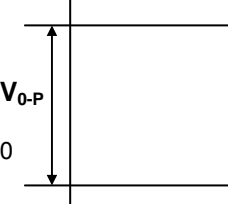
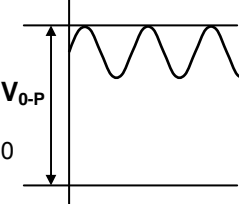
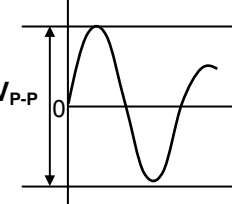
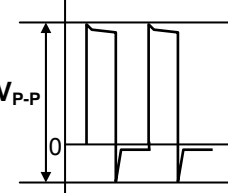
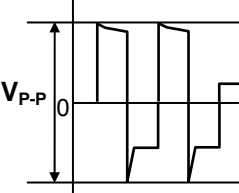
No.	Process	Condition														
1	Operating Condition (Storage, Transportation)	<p>1-1. Storage</p> <ol style="list-style-type: none"> 1) The capacitors must be stored in an ambient temperature of 5 to 40°C with a relative humidity of 20 to 70%RH. The products should be used within 6 months upon receipt. 2) The capacitors must be operated and stored in an environment free of dew condensation and these gases such as Hydrogen Sulphide, Hydrogen Sulphate, Chlorine, Ammonia and sulfur. 3) Avoid storing in sun light and falling of dew. 4) Do not use capacitors under high humidity and high and low atmospheric pressure which may affect capacitors reliability. 5) Capacitors should be tested for the solderability when they are stored for long time. <p>1-2. Handling in transportation In case of the transportation of the capacitors, the performance of the capacitors may be deteriorated depending on the transportation condition. (Refer to JEITA RCR-2335B 9.2 Handling in transportation)</p>														
2	Circuit design ⚠ Caution	<p>2-1. Operating temperature Operating temperature should be followed strictly within this specification, especially be careful with maximum temperature.</p> <ol style="list-style-type: none"> 1) Do not use capacitors above the maximum allowable operating temperature. 2) Surface temperature including self heating should be below maximum operating temperature. (Due to dielectric loss, capacitors will heat itself when AC is applied. Especially at high frequencies around its SRF, the heat might be so extreme that it may damage itself or the product mounted on. Please design the circuit so that the maximum temperature of the capacitors including the self heating to be below the maximum allowable operating temperature. Temperature rise at capacitor surface shall be below 20°C) 3) The electrical characteristics of the capacitors will vary depending on the temperature. The capacitors should be selected and designed in taking the temperature into consideration. <p>2-2. Operating voltage</p> <ol style="list-style-type: none"> 1) Operating voltage across the terminals should be below the rated voltage. When AC and DC are super imposed, V_{0-P} must be below the rated voltage. — (1) and (2) AC or pulse with overshooting, V_{P-P} must be below the rated voltage. — (3), (4) and (5) When the voltage is started to apply to the circuit or it is stopped applying, the irregular voltage may be generated for a transit period because of resonance or switching. Be sure to use the capacitors within rated voltage containing these Irregular voltage. <table border="1" data-bbox="470 1473 1444 1749"> <thead> <tr> <th data-bbox="470 1473 662 1518">Voltage</th> <th data-bbox="662 1473 922 1518">(1) DC voltage</th> <th data-bbox="922 1473 1182 1518">(2) DC+AC voltage</th> <th data-bbox="1182 1473 1444 1518">(3) AC voltage</th> </tr> </thead> <tbody> <tr> <td data-bbox="470 1518 662 1749">Positional Measurement (Rated voltage)</td> <td data-bbox="662 1518 922 1749">  </td> <td data-bbox="922 1518 1182 1749">  </td> <td data-bbox="1182 1518 1444 1749">  </td> </tr> </tbody> </table> <table border="1" data-bbox="470 1780 1444 2045"> <thead> <tr> <th data-bbox="470 1780 662 1825">Voltage</th> <th data-bbox="662 1780 922 1825">(4) Pulse voltage (A)</th> <th data-bbox="922 1780 1444 1825">(5) Pulse voltage (B)</th> </tr> </thead> <tbody> <tr> <td data-bbox="470 1825 662 2045">Positional Measurement (Rated voltage)</td> <td data-bbox="662 1825 922 2045">  </td> <td data-bbox="922 1825 1444 2045">  </td> </tr> </tbody> </table>	Voltage	(1) DC voltage	(2) DC+AC voltage	(3) AC voltage	Positional Measurement (Rated voltage)				Voltage	(4) Pulse voltage (A)	(5) Pulse voltage (B)	Positional Measurement (Rated voltage)		
Voltage	(1) DC voltage	(2) DC+AC voltage	(3) AC voltage													
Positional Measurement (Rated voltage)																
Voltage	(4) Pulse voltage (A)	(5) Pulse voltage (B)														
Positional Measurement (Rated voltage)																

No.	Process	Condition																																																												
2	Circuit design ⚠ Caution	<p>2) Even below the rated voltage, if repetitive high frequency AC or pulse is applied, the reliability of the capacitors may be reduced.</p> <p>3) The effective capacitance will vary depending on applied DC and AC voltages. The capacitors should be selected and designed in taking the voltages into consideration.</p> <p>2-3. Frequency When the capacitors (Class 2) are used in AC and/or pulse voltages, the capacitors may vibrate themselves and generate audible sound.</p>																																																												
3	Designing P.C.board	<p>The amount of solder at the terminations has a direct effect on the reliability of the capacitors.</p> <p>1) The greater the amount of solder, the higher the stress on the chip capacitors, and the more likely that it will break. When designing a P.C.board, determine the shape and size of the solder lands to have proper amount of solder on the terminations.</p> <p>2) Avoid using common solder land for multiple terminations and provide individual solder land for each terminations.</p> <p>3) Size and recommended land dimensions.</p> <div style="text-align: center;"> <p>The diagram illustrates the recommended dimensions for solder lands on a PCB. It shows two chip capacitors mounted on a board. Dimension 'A' is the length of the solder land between the two capacitors. Dimension 'B' is the length of the solder land on each side of a capacitor. Dimension 'C' is the width of the solder land. Labels include 'Chip capacitors', 'Solder land', and 'Solder resist'.</p> </div> <table border="1" style="width: 100%; border-collapse: collapse; margin-top: 10px;"> <caption style="text-align: center;">Flow soldering (mm)</caption> <thead> <tr> <th>Type</th> <th>C1608 (CC0603)</th> <th>C2012 (CC0805)</th> <th>C3216 (CC1206)</th> </tr> </thead> <tbody> <tr> <td>A</td> <td>0.7 - 1.0</td> <td>1.0 - 1.3</td> <td>2.1 - 2.5</td> </tr> <tr> <td>B</td> <td>0.8 - 1.0</td> <td>1.0 - 1.2</td> <td>1.1 - 1.3</td> </tr> <tr> <td>C</td> <td>0.6 - 0.8</td> <td>0.8 - 1.1</td> <td>1.0 - 1.3</td> </tr> </tbody> </table> <table border="1" style="width: 100%; border-collapse: collapse; margin-top: 10px;"> <caption style="text-align: center;">Reflow soldering (mm)</caption> <thead> <tr> <th>Type</th> <th>C0402 (CC01005)</th> <th>C0603 (CC0201)</th> <th>C1005 (CC0402)</th> <th>C1608 (CC0603)</th> <th>C2012 (CC0805)</th> </tr> </thead> <tbody> <tr> <td>A</td> <td>0.15 - 0.25</td> <td>0.25 - 0.35</td> <td>0.3 - 0.5</td> <td>0.6 - 0.8</td> <td>0.9 - 1.2</td> </tr> <tr> <td>B</td> <td>0.15 - 0.25</td> <td>0.2 - 0.3</td> <td>0.35 - 0.45</td> <td>0.6 - 0.8</td> <td>0.7 - 0.9</td> </tr> <tr> <td>C</td> <td>0.15 - 0.25</td> <td>0.25 - 0.35</td> <td>0.4 - 0.6</td> <td>0.6 - 0.8</td> <td>0.9 - 1.2</td> </tr> </tbody> </table> <table border="1" style="width: 100%; border-collapse: collapse; margin-top: 10px;"> <thead> <tr> <th>Type</th> <th>C3216 (CC1206)</th> <th>C3225 (CC1210)</th> <th>C4532 (CC1812)</th> <th>C5750 (CC2220)</th> </tr> </thead> <tbody> <tr> <td>A</td> <td>2.0 - 2.4</td> <td>2.0 - 2.4</td> <td>3.1 - 3.7</td> <td>4.1 - 4.8</td> </tr> <tr> <td>B</td> <td>1.0 - 1.2</td> <td>1.0 - 1.2</td> <td>1.2 - 1.4</td> <td>1.2 - 1.4</td> </tr> <tr> <td>C</td> <td>1.1 - 1.6</td> <td>1.9 - 2.5</td> <td>2.4 - 3.2</td> <td>4.0 - 5.0</td> </tr> </tbody> </table>	Type	C1608 (CC0603)	C2012 (CC0805)	C3216 (CC1206)	A	0.7 - 1.0	1.0 - 1.3	2.1 - 2.5	B	0.8 - 1.0	1.0 - 1.2	1.1 - 1.3	C	0.6 - 0.8	0.8 - 1.1	1.0 - 1.3	Type	C0402 (CC01005)	C0603 (CC0201)	C1005 (CC0402)	C1608 (CC0603)	C2012 (CC0805)	A	0.15 - 0.25	0.25 - 0.35	0.3 - 0.5	0.6 - 0.8	0.9 - 1.2	B	0.15 - 0.25	0.2 - 0.3	0.35 - 0.45	0.6 - 0.8	0.7 - 0.9	C	0.15 - 0.25	0.25 - 0.35	0.4 - 0.6	0.6 - 0.8	0.9 - 1.2	Type	C3216 (CC1206)	C3225 (CC1210)	C4532 (CC1812)	C5750 (CC2220)	A	2.0 - 2.4	2.0 - 2.4	3.1 - 3.7	4.1 - 4.8	B	1.0 - 1.2	1.0 - 1.2	1.2 - 1.4	1.2 - 1.4	C	1.1 - 1.6	1.9 - 2.5	2.4 - 3.2	4.0 - 5.0
Type	C1608 (CC0603)	C2012 (CC0805)	C3216 (CC1206)																																																											
A	0.7 - 1.0	1.0 - 1.3	2.1 - 2.5																																																											
B	0.8 - 1.0	1.0 - 1.2	1.1 - 1.3																																																											
C	0.6 - 0.8	0.8 - 1.1	1.0 - 1.3																																																											
Type	C0402 (CC01005)	C0603 (CC0201)	C1005 (CC0402)	C1608 (CC0603)	C2012 (CC0805)																																																									
A	0.15 - 0.25	0.25 - 0.35	0.3 - 0.5	0.6 - 0.8	0.9 - 1.2																																																									
B	0.15 - 0.25	0.2 - 0.3	0.35 - 0.45	0.6 - 0.8	0.7 - 0.9																																																									
C	0.15 - 0.25	0.25 - 0.35	0.4 - 0.6	0.6 - 0.8	0.9 - 1.2																																																									
Type	C3216 (CC1206)	C3225 (CC1210)	C4532 (CC1812)	C5750 (CC2220)																																																										
A	2.0 - 2.4	2.0 - 2.4	3.1 - 3.7	4.1 - 4.8																																																										
B	1.0 - 1.2	1.0 - 1.2	1.2 - 1.4	1.2 - 1.4																																																										
C	1.1 - 1.6	1.9 - 2.5	2.4 - 3.2	4.0 - 5.0																																																										

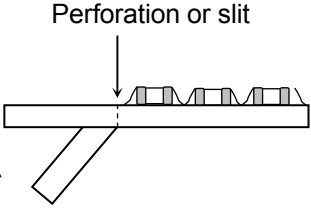
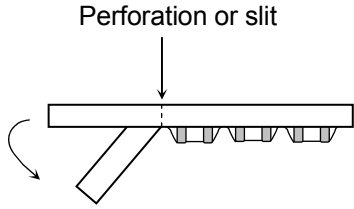
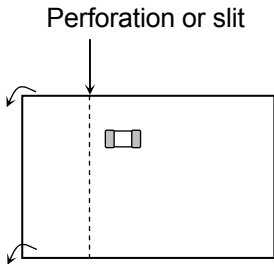
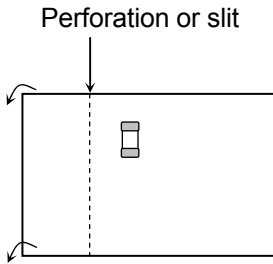
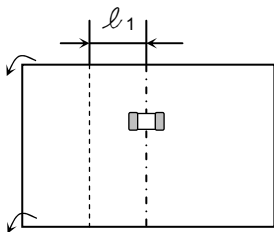
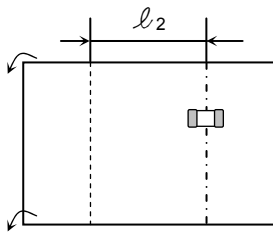
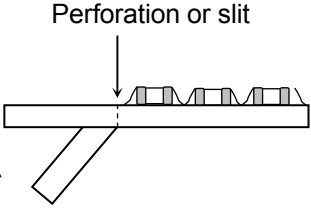
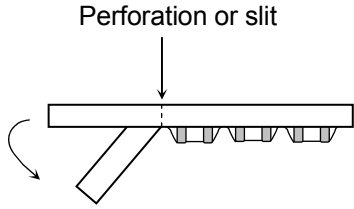
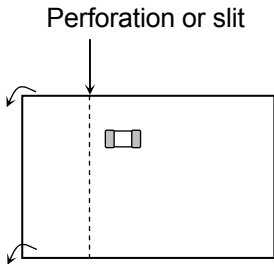
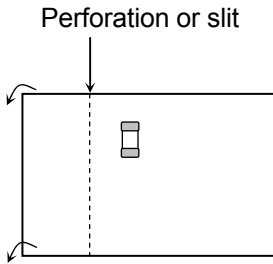
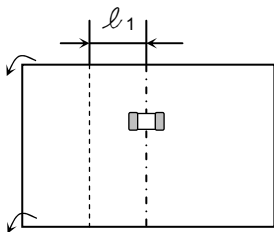
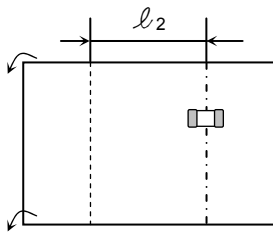
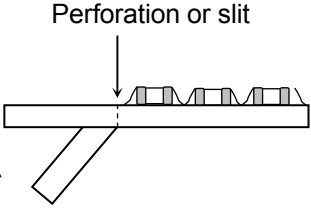
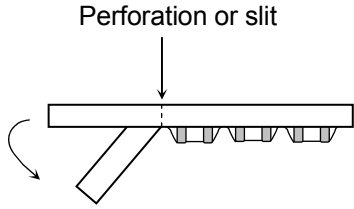
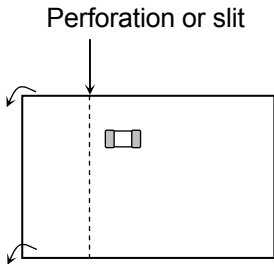
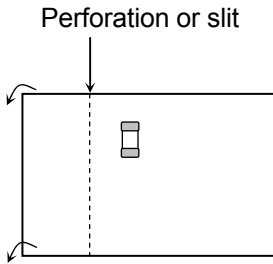
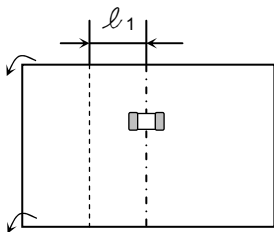
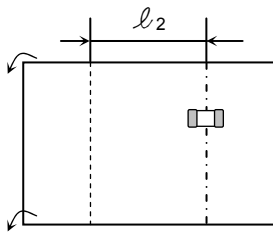
No.	Process	Condition												
3	Designing P.C.board	<p>4) Recommended chip capacitors layout is as following.</p> <table border="1" data-bbox="472 219 1426 1637"> <thead> <tr> <th data-bbox="472 219 660 297"></th> <th data-bbox="660 219 1043 297">Disadvantage against bending stress</th> <th data-bbox="1043 219 1426 297">Advantage against bending stress</th> </tr> </thead> <tbody> <tr> <td data-bbox="472 297 660 712">Mounting face</td> <td data-bbox="660 297 1043 712"> <p>Perforation or slit</p>  <p>Break P.C.board with mounted side up.</p> </td> <td data-bbox="1043 297 1426 712"> <p>Perforation or slit</p>  <p>Break P.C.board with mounted side down.</p> </td> </tr> <tr> <td data-bbox="472 712 660 1160">Chip arrangement (Direction)</td> <td data-bbox="660 712 1043 1160"> <p>Mount perpendicularly to perforation or slit</p> <p>Perforation or slit</p>  </td> <td data-bbox="1043 712 1426 1160"> <p>Mount in parallel with perforation or slit</p> <p>Perforation or slit</p>  </td> </tr> <tr> <td data-bbox="472 1160 660 1637">Distance from slit</td> <td data-bbox="660 1160 1043 1637"> <p>Closer to slit is higher stress</p>  <p>$(l_1 < l_2)$</p> </td> <td data-bbox="1043 1160 1426 1637"> <p>Away from slit is less stress</p>  <p>$(l_1 < l_2)$</p> </td> </tr> </tbody> </table>		Disadvantage against bending stress	Advantage against bending stress	Mounting face	<p>Perforation or slit</p>  <p>Break P.C.board with mounted side up.</p>	<p>Perforation or slit</p>  <p>Break P.C.board with mounted side down.</p>	Chip arrangement (Direction)	<p>Mount perpendicularly to perforation or slit</p> <p>Perforation or slit</p> 	<p>Mount in parallel with perforation or slit</p> <p>Perforation or slit</p> 	Distance from slit	<p>Closer to slit is higher stress</p>  <p>$(l_1 < l_2)$</p>	<p>Away from slit is less stress</p>  <p>$(l_1 < l_2)$</p>
	Disadvantage against bending stress	Advantage against bending stress												
Mounting face	<p>Perforation or slit</p>  <p>Break P.C.board with mounted side up.</p>	<p>Perforation or slit</p>  <p>Break P.C.board with mounted side down.</p>												
Chip arrangement (Direction)	<p>Mount perpendicularly to perforation or slit</p> <p>Perforation or slit</p> 	<p>Mount in parallel with perforation or slit</p> <p>Perforation or slit</p> 												
Distance from slit	<p>Closer to slit is higher stress</p>  <p>$(l_1 < l_2)$</p>	<p>Away from slit is less stress</p>  <p>$(l_1 < l_2)$</p>												

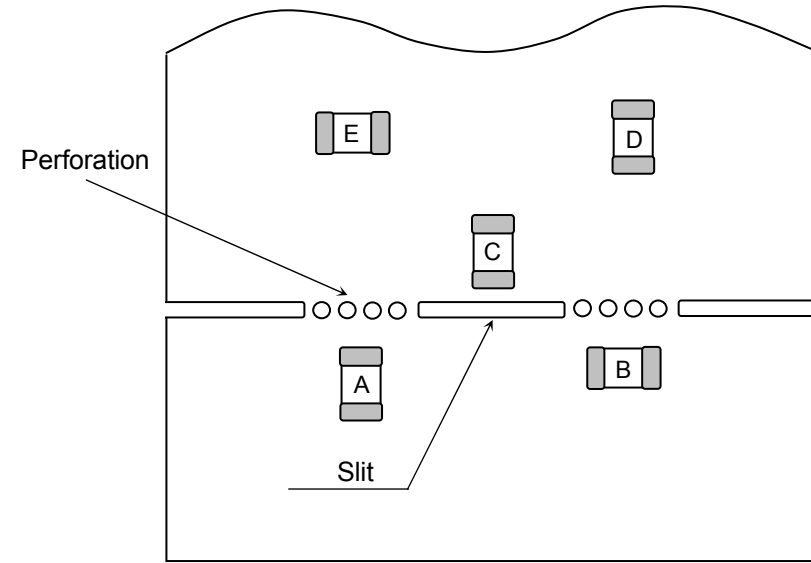
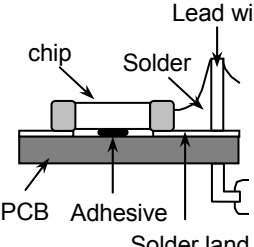
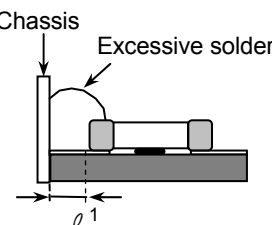
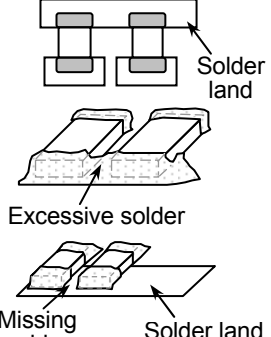
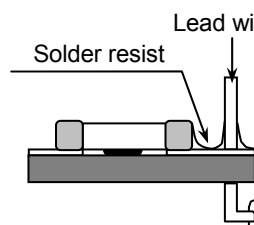
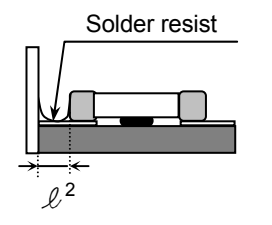
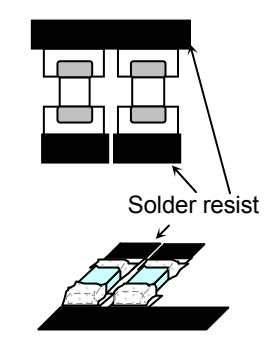
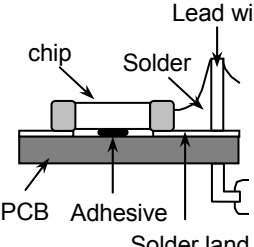
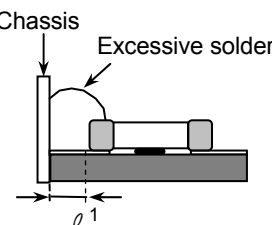
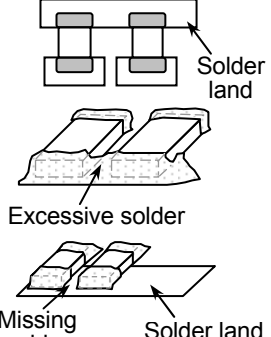
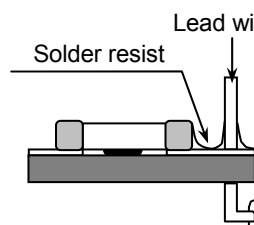
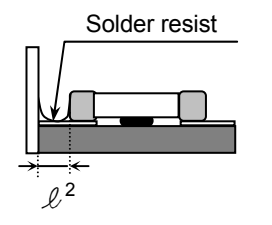
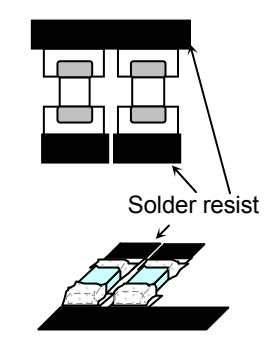
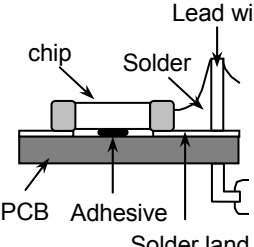
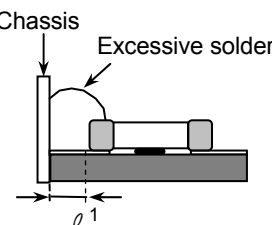
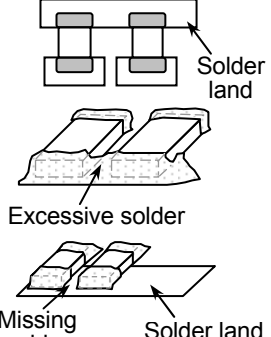
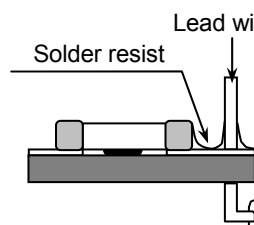
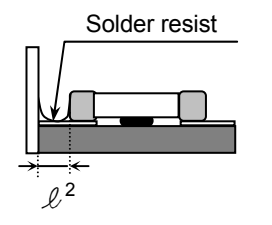
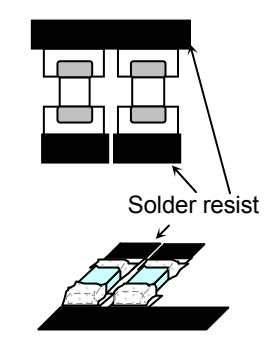
No.	Process	Condition												
3	Designing P.C.board	<p>5) Mechanical stress varies according to location of chip capacitors on the P.C.board.</p>  <p>The stress in capacitors is in the following order. $A > B = C > D > E$</p> <p>6) Layout recommendation</p> <table border="1"> <thead> <tr> <th data-bbox="379 1008 539 1120">Example</th> <th data-bbox="539 1008 842 1120">Use of common solder land</th> <th data-bbox="842 1008 1153 1120">Soldering with chassis</th> <th data-bbox="1153 1008 1481 1120">Use of common solder land with other SMD</th> </tr> </thead> <tbody> <tr> <td data-bbox="379 1120 539 1500">Need to avoid</td> <td data-bbox="539 1120 842 1500">  </td> <td data-bbox="842 1120 1153 1500">  </td> <td data-bbox="1153 1120 1481 1500">  </td> </tr> <tr> <td data-bbox="379 1500 539 1915">Recommendation</td> <td data-bbox="539 1500 842 1915">  </td> <td data-bbox="842 1500 1153 1915">  <p>$l^2 > l^1$</p> </td> <td data-bbox="1153 1500 1481 1915">  </td> </tr> </tbody> </table>	Example	Use of common solder land	Soldering with chassis	Use of common solder land with other SMD	Need to avoid				Recommendation		 <p>$l^2 > l^1$</p>	
Example	Use of common solder land	Soldering with chassis	Use of common solder land with other SMD											
Need to avoid														
Recommendation		 <p>$l^2 > l^1$</p>												

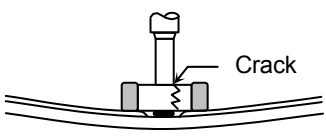
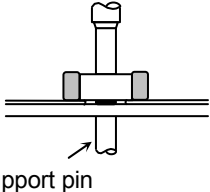
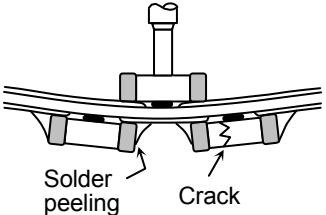
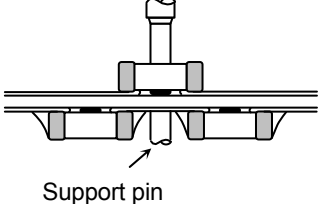
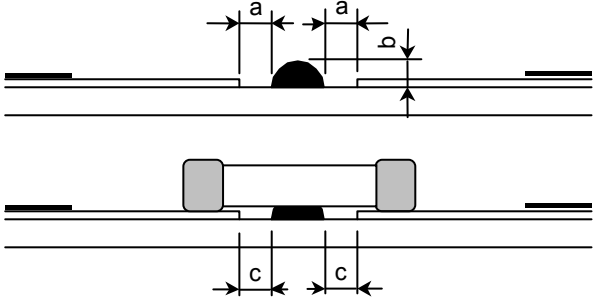
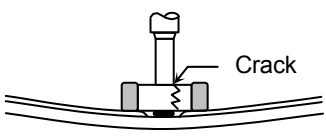
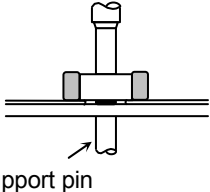
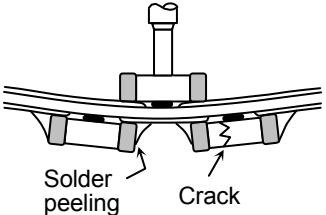
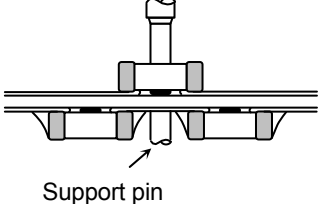
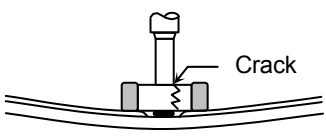
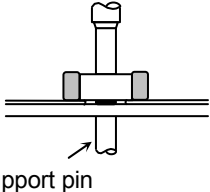
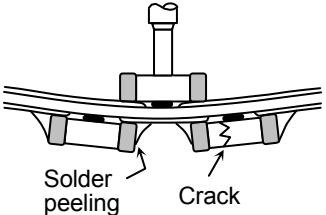
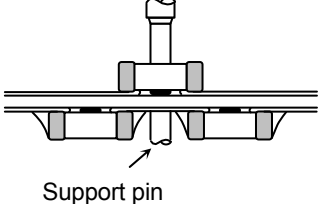
No.	Process	Condition															
4	Mounting	<p>4-1. Stress from mounting head If the mounting head is adjusted too low, it may induce excessive stress in the chip capacitors to result in cracking. Please take following precautions.</p> <ol style="list-style-type: none"> 1) Adjust the bottom dead center of the mounting head to reach on the P.C.board surface and not press it. 2) Adjust the mounting head pressure to be 1 to 3N of static weight. 3) To minimize the impact energy from mounting head, it is important to provide support from the bottom side of the P.C.board. See following examples. <table border="1" data-bbox="480 600 1433 1160"> <thead> <tr> <th></th> <th data-bbox="667 600 1061 651">Not recommended</th> <th data-bbox="1061 600 1433 651">Recommended</th> </tr> </thead> <tbody> <tr> <td data-bbox="480 651 667 898">Single sided mounting</td> <td data-bbox="667 651 1061 898">  </td> <td data-bbox="1061 651 1433 898">  </td> </tr> <tr> <td data-bbox="480 898 667 1160">Double-sides mounting</td> <td data-bbox="667 898 1061 1160">  </td> <td data-bbox="1061 898 1433 1160">  </td> </tr> </tbody> </table> <p>When the centering jaw is worn out, it may give mechanical impact on the capacitors to cause crack. Please control the close up dimension of the centering jaw and provide sufficient preventive maintenance and replacement of it.</p> <p>4-2. Amount of adhesive</p>  <p>Example : C2012 (CC0805), C3216 (CC1206)</p> <table border="1" data-bbox="662 1783 1214 1944"> <tbody> <tr> <td data-bbox="662 1783 810 1839">a</td> <td data-bbox="810 1783 1214 1839">0.2mm min.</td> </tr> <tr> <td data-bbox="662 1839 810 1895">b</td> <td data-bbox="810 1839 1214 1895">70 - 100μm</td> </tr> <tr> <td data-bbox="662 1895 810 1944">c</td> <td data-bbox="810 1895 1214 1944">Do not touch the solder land</td> </tr> </tbody> </table>		Not recommended	Recommended	Single sided mounting			Double-sides mounting			a	0.2mm min.	b	70 - 100 μ m	c	Do not touch the solder land
	Not recommended	Recommended															
Single sided mounting																	
Double-sides mounting																	
a	0.2mm min.																
b	70 - 100 μ m																
c	Do not touch the solder land																

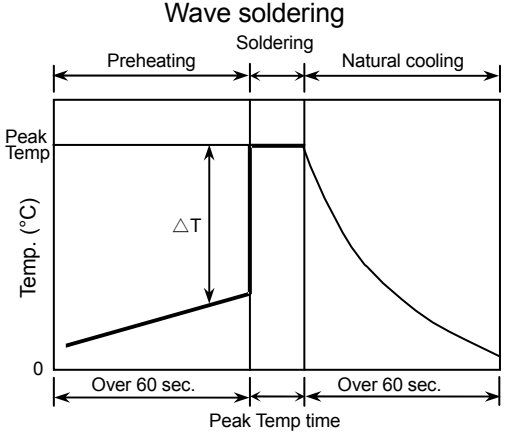
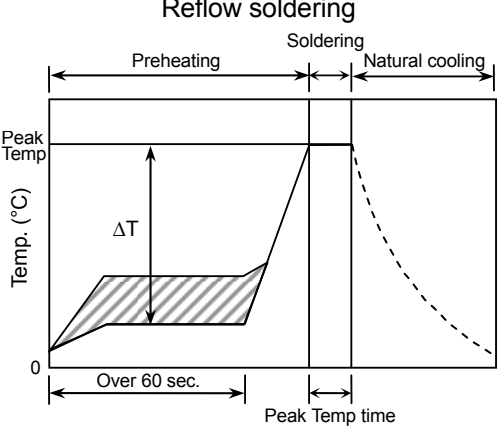
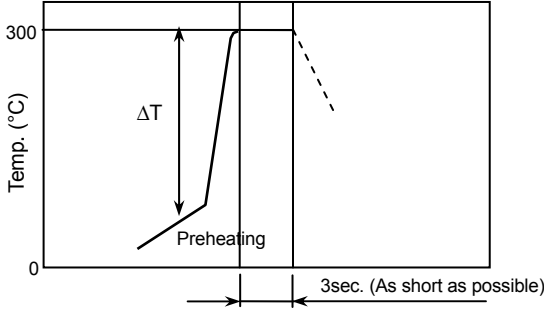
No.	Process	Condition																			
5	Soldering	<p>5-1. Flux selection</p> <p>Although highly-activated flux gives better solderability, substances which increase activity may also degrade the insulation of the chip capacitors. To avoid such degradation, it is recommended following.</p> <ol style="list-style-type: none"> 1) It is recommended to use a mildly activated rosin flux (less than 0.1wt% chlorine). Strong flux is not recommended. 2) Excessive flux must be avoided. Please provide proper amount of flux. 3) When water-soluble flux is used, enough washing is necessary. <p>5-2. Recommended soldering profile by various methods</p> <div style="display: flex; justify-content: space-around;"> <div style="text-align: center;"> <p>Wave soldering</p>  </div> <div style="text-align: center;"> <p>Reflow soldering</p>  </div> </div> <div style="text-align: center; margin-top: 20px;"> <p>Manual soldering (Solder iron)</p>  </div> <div style="margin-top: 20px;"> <p>APPLICATION</p> <p>As for C1608 (CC0603), C2012 (CC0805) and C3216 (CC1206), applied to wave soldering and reflow soldering.</p> <p>As for C0402 (CC01005), C0603 (CC0201), C1005 (CC0402), C3225 (CC1210), C4532 (CC1812), C5750 (CC2220), applied only to reflow soldering.</p> </div> <p>5-3. Recommended soldering peak temp and peak temp duration</p> <table border="1" style="width: 100%; border-collapse: collapse;"> <thead> <tr> <th rowspan="2" style="text-align: center;">Temp./Duration</th> <th colspan="2" style="text-align: center;">Wave soldering</th> <th colspan="2" style="text-align: center;">Reflow soldering</th> </tr> <tr> <th style="text-align: center;">Peak temp(°C)</th> <th style="text-align: center;">Duration(sec.)</th> <th style="text-align: center;">Peak temp(°C)</th> <th style="text-align: center;">Duration(sec.)</th> </tr> </thead> <tbody> <tr> <td style="text-align: center;">Sn-Pb Solder</td> <td style="text-align: center;">250 max.</td> <td style="text-align: center;">3 max.</td> <td style="text-align: center;">230 max.</td> <td style="text-align: center;">20 max.</td> </tr> <tr> <td style="text-align: center;">Lead Free Solder</td> <td style="text-align: center;">260 max.</td> <td style="text-align: center;">5 max.</td> <td style="text-align: center;">260 max.</td> <td style="text-align: center;">10 max.</td> </tr> </tbody> </table> <p>Recommended solder compositions</p> <p>Sn-37Pb (Sn-Pb solder)</p> <p>Sn-3.0Ag-0.5Cu (Lead Free Solder)</p>	Temp./Duration	Wave soldering		Reflow soldering		Peak temp(°C)	Duration(sec.)	Peak temp(°C)	Duration(sec.)	Sn-Pb Solder	250 max.	3 max.	230 max.	20 max.	Lead Free Solder	260 max.	5 max.	260 max.	10 max.
Temp./Duration	Wave soldering			Reflow soldering																	
	Peak temp(°C)	Duration(sec.)	Peak temp(°C)	Duration(sec.)																	
Sn-Pb Solder	250 max.	3 max.	230 max.	20 max.																	
Lead Free Solder	260 max.	5 max.	260 max.	10 max.																	

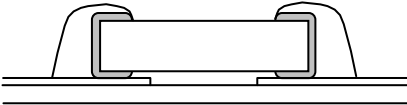
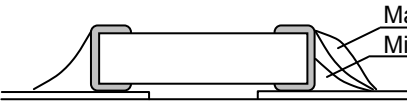
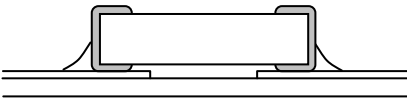
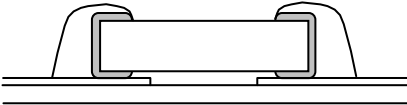
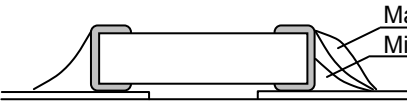
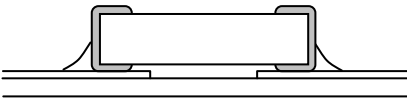
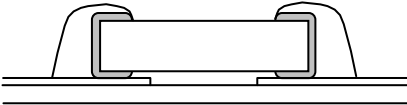
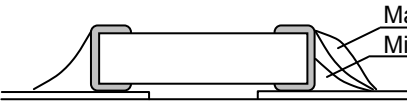
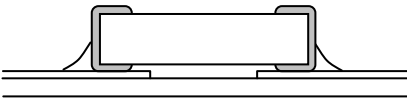
No.	Process	Condition																																	
5	Soldering	<p>5-4. Avoiding thermal shock</p> <p>1) Preheating condition</p> <table border="1" data-bbox="552 264 1426 694"> <thead> <tr> <th>Soldering</th> <th>Type</th> <th>Temp. (°C)</th> </tr> </thead> <tbody> <tr> <td>Wave soldering</td> <td>C1608(CC0603), C2012(CC0805), C3216(CC1206)</td> <td>$\Delta T \leq 150$</td> </tr> <tr> <td rowspan="2">Reflow soldering</td> <td>C0402(CC01005), C0603(CC0201), C1005(CC0402), C1608(CC0603), C2012(CC0805), C3216(CC1206)</td> <td>$\Delta T \leq 150$</td> </tr> <tr> <td>C3225(CC1210), C4532(CC1812), C5750(CC2220)</td> <td>$\Delta T \leq 130$</td> </tr> <tr> <td rowspan="2">Manual soldering</td> <td>C0402(CC01005), C0603(CC0201), C1005(CC0402), C1608(CC0603), C2012(CC0805), C3216(CC1206)</td> <td>$\Delta T \leq 150$</td> </tr> <tr> <td>C3225(CC1210), C4532(CC1812), C5750(CC2220)</td> <td>$\Delta T \leq 130$</td> </tr> </tbody> </table> <p>2) Cooling condition Natural cooling using air is recommended. If the chips are dipped into a solvent for cleaning, the temperature difference (ΔT) must be less than 100°C.</p> <p>5-5. Amount of solder</p> <p>Excessive solder will induce higher tensile force in chip capacitors when temperature changes and it may result in chip cracking. In sufficient solder may detach the capacitors from the P.C.board.</p> <table border="1" data-bbox="496 1059 1445 1523"> <tbody> <tr> <td data-bbox="496 1104 638 1171">Excessive solder</td> <td data-bbox="699 1093 1107 1196">  </td> <td data-bbox="1134 1093 1422 1182">Higher tensile force in chip capacitors to cause crack</td> </tr> <tr> <td data-bbox="496 1272 624 1305">Adequate</td> <td data-bbox="699 1234 1107 1337">  </td> <td></td> </tr> <tr> <td data-bbox="496 1413 638 1480">Insufficient solder</td> <td data-bbox="699 1402 1107 1505">  </td> <td data-bbox="1134 1384 1422 1505">Low robustness may cause contact failure or chip capacitors come off the P.C.board.</td> </tr> </tbody> </table> <p>5-6. Solder repair by solder iron</p> <p>1) Selection of the soldering iron tip</p> <p>Tip temperature of solder iron varies by its type, P.C.board material and solder land size. The higher the tip temperature, the quicker the operation. However, heat shock may cause a crack in the chip capacitors. Please make sure the tip temp. before soldering and keep the peak temp and time in accordance with following recommended condition. (Please preheat the chip capacitors with the condition in 5-4 to avoid the thermal shock.)</p> <p>Recommended solder iron condition (Sn-Pb Solder and Lead Free Solder)</p> <table border="1" data-bbox="552 1895 1390 2000"> <thead> <tr> <th>Temp. (°C)</th> <th>Duration (sec.)</th> <th>Wattage (W)</th> <th>Shape (mm)</th> </tr> </thead> <tbody> <tr> <td>300 max.</td> <td>3 max.</td> <td>20 max.</td> <td>Ø 3.0 max.</td> </tr> </tbody> </table>	Soldering	Type	Temp. (°C)	Wave soldering	C1608(CC0603), C2012(CC0805), C3216(CC1206)	$\Delta T \leq 150$	Reflow soldering	C0402(CC01005), C0603(CC0201), C1005(CC0402), C1608(CC0603), C2012(CC0805), C3216(CC1206)	$\Delta T \leq 150$	C3225(CC1210), C4532(CC1812), C5750(CC2220)	$\Delta T \leq 130$	Manual soldering	C0402(CC01005), C0603(CC0201), C1005(CC0402), C1608(CC0603), C2012(CC0805), C3216(CC1206)	$\Delta T \leq 150$	C3225(CC1210), C4532(CC1812), C5750(CC2220)	$\Delta T \leq 130$	Excessive solder		Higher tensile force in chip capacitors to cause crack	Adequate			Insufficient solder		Low robustness may cause contact failure or chip capacitors come off the P.C.board.	Temp. (°C)	Duration (sec.)	Wattage (W)	Shape (mm)	300 max.	3 max.	20 max.	Ø 3.0 max.
Soldering	Type	Temp. (°C)																																	
Wave soldering	C1608(CC0603), C2012(CC0805), C3216(CC1206)	$\Delta T \leq 150$																																	
Reflow soldering	C0402(CC01005), C0603(CC0201), C1005(CC0402), C1608(CC0603), C2012(CC0805), C3216(CC1206)	$\Delta T \leq 150$																																	
	C3225(CC1210), C4532(CC1812), C5750(CC2220)	$\Delta T \leq 130$																																	
Manual soldering	C0402(CC01005), C0603(CC0201), C1005(CC0402), C1608(CC0603), C2012(CC0805), C3216(CC1206)	$\Delta T \leq 150$																																	
	C3225(CC1210), C4532(CC1812), C5750(CC2220)	$\Delta T \leq 130$																																	
Excessive solder		Higher tensile force in chip capacitors to cause crack																																	
Adequate																																			
Insufficient solder		Low robustness may cause contact failure or chip capacitors come off the P.C.board.																																	
Temp. (°C)	Duration (sec.)	Wattage (W)	Shape (mm)																																
300 max.	3 max.	20 max.	Ø 3.0 max.																																

No.	Process	Condition
5	Soldering	<p>2) Direct contact of the soldering iron with ceramic dielectric of chip capacitors may cause crack. Do not touch the ceramic dielectric and the terminations by solder iron.</p> <p>5-7. Sn-Zn solder Sn-Zn solder affects product reliability. Please contact TDK in advance when utilize Sn-Zn solder.</p> <p>5-8. Countermeasure for tombstone The misalignment between the mounted positions of the capacitors and the land patterns should be minimized. The tombstone phenomenon may occur especially the capacitors are mounted (in longitudinal direction) in the same direction of the reflow soldering. (Refer to JEITA RCR-2335B Annex 1 (Informative) Recommendations to prevent the tombstone phenomenon)</p>
6	Cleaning	<p>1) If an unsuitable cleaning fluid is used, flux residue or some foreign articles may stick to chip capacitors surface to deteriorate especially the insulation resistance.</p> <p>2) If cleaning condition is not suitable, it may damage the chip capacitors.</p> <p>2)-1. Insufficient washing</p> <p>(1) Terminal electrodes may corrode by Halogen in the flux.</p> <p>(2) Halogen in the flux may adhere on the surface of capacitors, and lower the insulation resistance.</p> <p>(3) Water soluble flux has higher tendency to have above mentioned problems (1) and (2).</p> <p>2)-2. Excessive washing</p> <p>When ultrasonic cleaning is used, excessively high ultrasonic energy output can affect the connection between the ceramic chip capacitor's body and the terminal electrode. To avoid this, following is the recommended condition.</p> <p style="text-align: center;">Power : 20 W/l max. Frequency : 40 kHz max. Washing time : 5 minutes max.</p> <p>2)-3. If the cleaning fluid is contaminated, density of Halogen increases, and it may bring the same result as insufficient cleaning.</p>

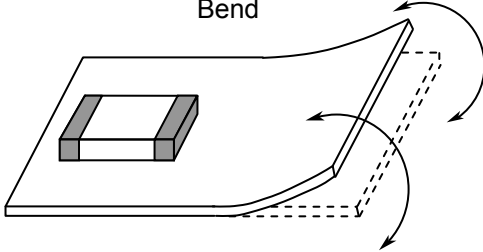
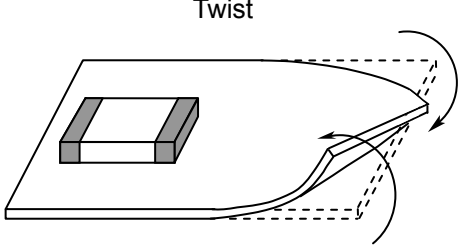
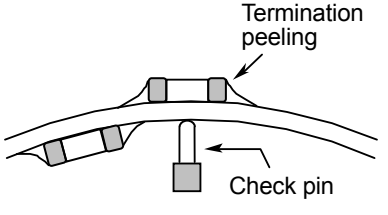
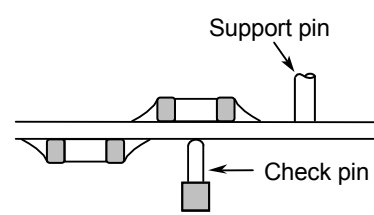
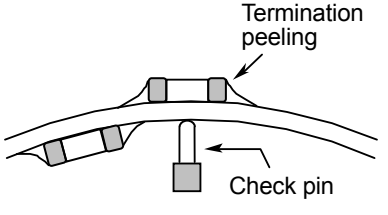
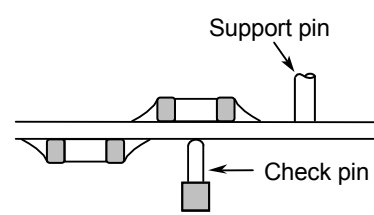
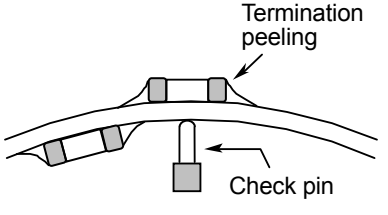
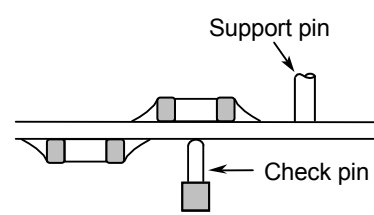
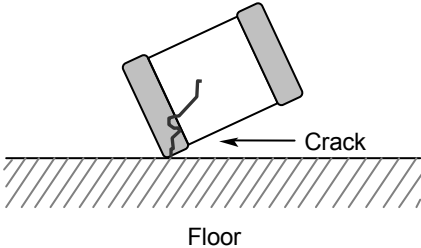
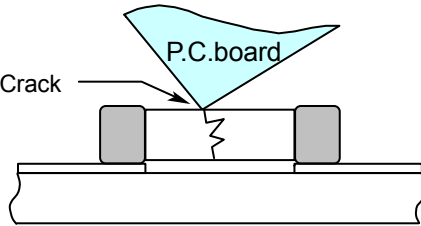
No.	Process	Condition						
7	Coating and molding of the P.C.board	<p>1) When the P.C.board is coated, please verify the quality influence on the product.</p> <p>2) Please verify carefully that there is no harmful decomposing or reaction gas emission during curing which may damage the chip capacitors.</p> <p>3) Please verify the curing temperature.</p>						
8	Handling after chip mounted ⚠ Caution	<p>1) Please pay attention not to bend or distort the P.C.board after soldering in handling otherwise the chip capacitors may crack.</p> <div style="display: flex; justify-content: space-around; align-items: center;"> <div style="text-align: center;"> <p>Bend</p>  </div> <div style="text-align: center;"> <p>Twist</p>  </div> </div> <p>2) When functional check of the P.C.board is performed, check pin pressure tends to be adjusted higher for fear of loose contact. But if the pressure is excessive and bend the P.C.board, it may crack the chip capacitors or peel the terminations off. Please adjust the check pins not to bend the P.C.board.</p> <table border="1" style="width: 100%; border-collapse: collapse;"> <thead> <tr> <th data-bbox="488 969 628 1032">Item</th> <th data-bbox="628 969 1046 1032">Not recommended</th> <th data-bbox="1046 969 1445 1032">Recommended</th> </tr> </thead> <tbody> <tr> <td data-bbox="488 1032 628 1267" style="text-align: center; vertical-align: middle;">Board bending</td> <td data-bbox="628 1032 1046 1267" style="text-align: center;">  </td> <td data-bbox="1046 1032 1445 1267" style="text-align: center;">  </td> </tr> </tbody> </table>	Item	Not recommended	Recommended	Board bending		
Item	Not recommended	Recommended						
Board bending								
9	Handling of loose chip capacitors	<p>1) If dropped the chip capacitors may crack. Once dropped do not use it. Especially, the large case sized chip capacitors are tendency to have cracks easily, so please handle with care.</p> <div style="text-align: center;">  </div> <p>2) Piling the P.C.board after mounting for storage or handling, the corner of the P.C. board may hit the chip capacitors of another board to cause crack.</p> <div style="text-align: center;">  </div>						

No.	Process	Condition
10	Capacitance aging	The capacitors (Class 2) have aging in the capacitance. They may not be used in precision time constant circuit. In case of the time constant circuit, the evaluation should be done well.
11	Estimated life and estimated failure rate of capacitors	As per the estimated life and the estimated failure rate depend on the temperature and the voltage. This can be calculated by the equation described in JEITA RCR-2335B Annex 6 (Informative) Calculation of the estimated lifetime and the estimated failure rate (Voltage acceleration coefficient : 3 multiplication rule, Temperature acceleration coefficient : 10°C rule) The failure rate can be decreased by reducing the temperature and the voltage but they will not be guaranteed.
12	Others △ Caution	<p>The products listed on this specification sheet are intended for use in general electronic equipment (AV equipment, telecommunications equipment, home appliances, amusement equipment, computer equipment, personal equipment, office equipment, measurement equipment, industrial robots) under a normal operation and use condition.</p> <p>The products are not designed or warranted to meet the requirements of the applications listed below, whose performance and/or quality require a more stringent level of safety or reliability, or whose failure, malfunction or trouble could cause serious damage to society, person or property. Please understand that we are not responsible for any damage or liability caused by use of the products in any of the applications below or for any other use exceeding the range or conditions set forth in this specification sheet. If you intend to use the products in the applications listed below or if you have special requirements exceeding the range or conditions set forth in this specification, please contact us.</p> <p>(1) Aerospace/Aviation equipment (2) Transportation equipment (cars, electric trains, ships, etc.) (3) Medical equipment (4) Power-generation control equipment (5) Atomic energy-related equipment (6) Seabed equipment (7) Transportation control equipment (8) Public information-processing equipment (9) Military equipment (10) Electric heating apparatus, burning equipment (11) Disaster prevention/crime prevention equipment (12) Safety equipment (13) Other applications that are not considered general-purpose applications</p> <p>When designing your equipment even for general-purpose applications, you are kindly requested to take into consideration securing protection circuit/device or providing backup circuits in your equipment.</p>

13. Packaging label

Packaging shall be done to protect the components from the damage during transportation and storing, and a label which has the following information shall be attached.

- 1) Inspection No.
- 2) TDK P/N
- 3) Customer's P/N
- 4) Quantity

*Composition of Inspection No.

Example M 2 A - 00 - 000
 (a) (b) (c) (d) (e)

- a) Line code
- b) Last digit of the year
- c) Month and A for January and B for February and so on. (Skip I)
- d) Inspection Date of the month.
- e) Serial No. of the day

14. Bulk packaging quantity

Total number of components in a plastic bag for bulk packaging: 1,000pcs.
As for C0402, C0603 and C1005 types, not available for bulk packaging.

15. TAPE PACKAGING SPECIFICATION

1. CONSTRUCTION AND DIMENSION OF TAPING

1-1. Dimensions of carrier tape

Dimensions of paper tape shall be according to Appendix 3, 4.

Dimensions of plastic tape shall be according to Appendix 5, 6.

1-2. Bulk part and leader of taping

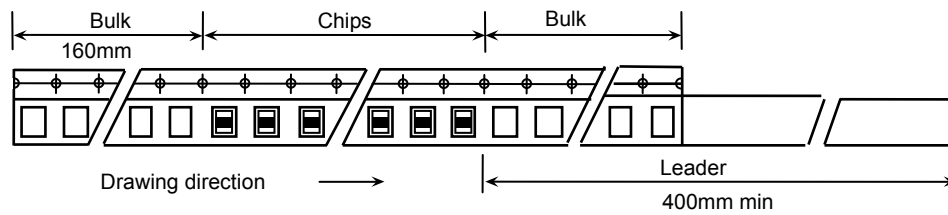

1-3. Dimensions of reel

Dimensions of $\varnothing 178$ reel shall be according to Appendix 7, 8.

Dimensions of $\varnothing 330$ reel shall be according to Appendix 9, 10.

1-4. Structure of taping

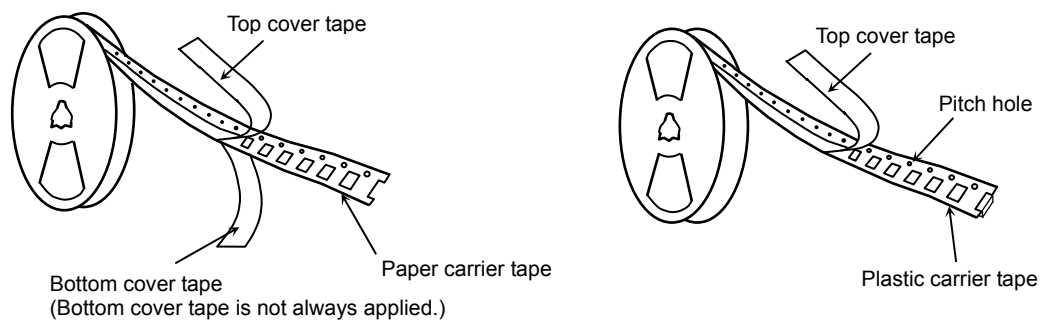

2. CHIP QUANTITY

Type	Thickness of chip	Taping Material	Chip quantity (pcs.)	
			φ178mm reel	φ330mm reel
C0402	0.20 mm	Paper	20,000	-
C0603	0.30 mm	Paper	15,000	-
C1005	0.50 mm	Paper	10,000	50,000
C1608	0.80 mm	Paper	4,000	10,000
C2012	0.60 mm	Paper	4,000	10,000
	0.85 mm	Paper or Plastic		
	1.25 mm	Plastic	2,000	
C3216	0.60 mm	Paper	4,000	10,000
	0.85 mm	Paper or Plastic		
	1.15 mm	Plastic	2,000	
	1.30 mm			
	1.60 mm			
C3225	1.15 mm	Plastic	2,000	10,000
	1.25 mm		2,000	8,000
	1.30 mm			
	1.60 mm			
	2.00 mm		1,000	5,000
	2.30 mm			
	2.50 mm			
C4532	1.60 mm	Plastic	1,000	3,000
	2.00 mm			
	2.30 mm		500	
	2.50 mm			
	2.80 mm			2,000
	3.20 mm			
C5750	2.00 mm	Plastic	500	3,000
	2.30 mm			
	2.50 mm			
	2.80 mm			2,000

3. PERFORMANCE SPECIFICATIONS

3-1. Fixing peeling strength (top tape)

0.05-0.7N. (See the following figure.)

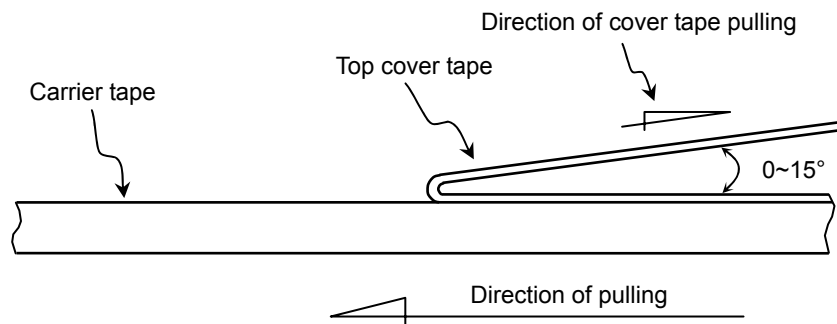

3-2. Carrier tape shall be flexible enough to be wound around a minimum radius of 30mm with components in tape.

3-3. The missing of components shall be less than 0.1%

3-4. Components shall not stick to fixing tape.

3-5. The fixing tapes shall not protrude beyond the edges of the carrier tape not shall cover the sprocket holes.

Appendix 3

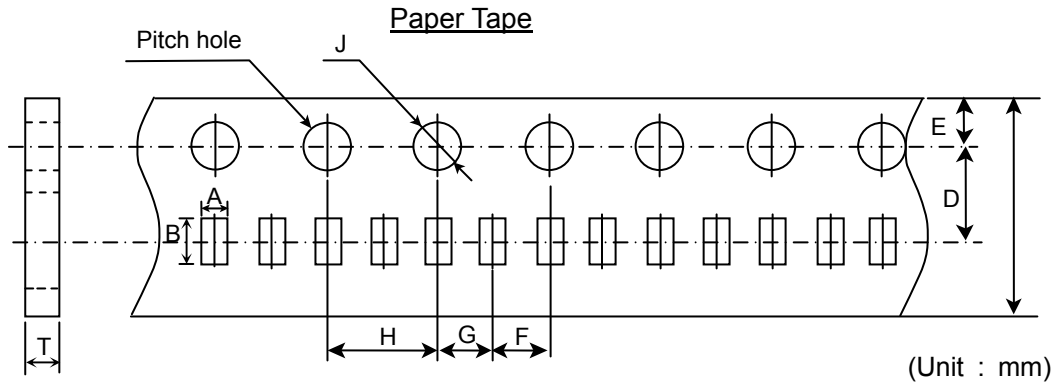

Symbol Type	A	B	C	D	E	F
C0402 (C01005)	(0.25)	(0.45)	8.00 ± 0.30	3.50 ± 0.05	1.75 ± 0.10	2.00 ± 0.05
C0603 (CC0201)	(0.38)	(0.68)				
C1005 (CC0402)	(0.65)	(1.15)				

Symbol Type	G	H	J	T
C0402 (C01005)	2.00 ± 0.05	4.00 ± 0.10	∅ 1.5 ^{+0.10} ₀	0.29 min.
C0603 (CC0201)				0.40 min.
C1005 (CC0402)				0.60 ± 0.15

* The values in the parentheses () are for reference.

Appendix 4

Paper Tape

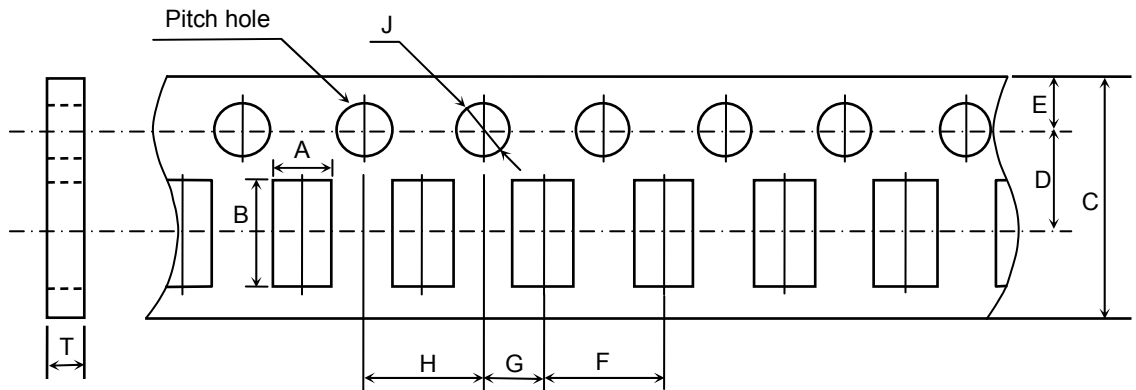

(Unit : mm)

Symbol Type	A	B	C	D	E	F
C1608 (CC0603)	(1.10)	(1.90)	8.00 ± 0.30	3.50 ± 0.05	1.75 ± 0.10	4.00 ± 0.10
C2012 (CC0805)	(1.50)	(2.30)				
C3216 (CC1206)	(1.90)	(3.50)				
Symbol Type	G	H	J	T		
C1608 (CC0603)	2.00 ± 0.05	4.00 ± 0.10	∅ 1.5 ^{+0.10} ₀	1.10 max.		
C2012 (CC0805)						
C3216 (CC1206)						

* The values in the parentheses () are for reference.

Appendix 5

Plastic Tape



(Unit : mm)

Symbol Type	A	B	C	D	E	F
C2012 (CC0805)	(1.50)	(2.30)	8.00 ± 0.30 [12.0 ± 0.30]	3.50 ± 0.05 [5.50 ± 0.05]	1.75 ± 0.10	4.00 ± 0.10
C3216 (CC1206)	(1.90)	(3.50)				
C3225 (CC1210)	(2.90)	(3.60)				
Symbol Type	G	H	J	K	t	Q
C2012 (CC0805)	2.00 ± 0.05	4.00 ± 0.10	∅ 1.5 $\begin{matrix} +0.10 \\ 0 \end{matrix}$	2.50 max.	0.30 max.	∅ 0.50 min.
C3216 (CC1206)				3.20 max.	0.60 max.	
C3225 (CC1210)						

* The values in the parentheses () are for reference.

* As for 2.5mm thickness products, apply values in the brackets [].

Appendix 6

Plastic Tape

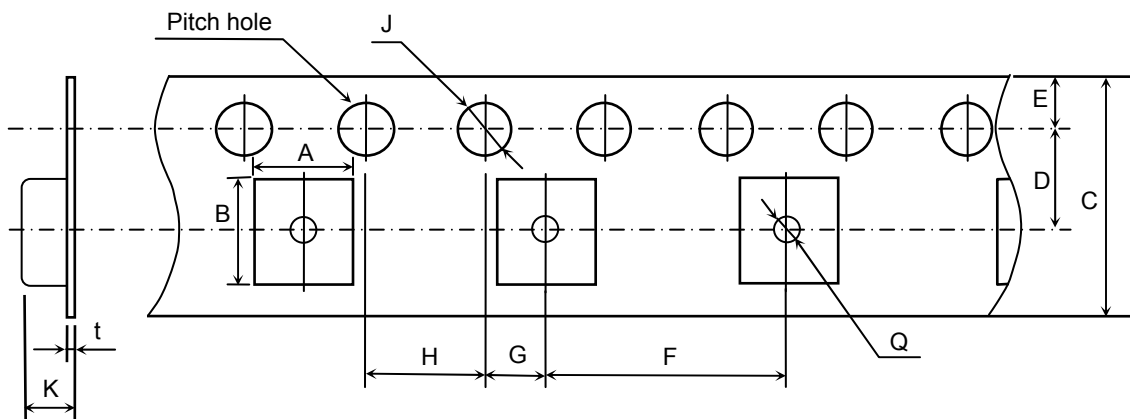

(Unit : mm)

Symbol Type	A	B	C	D	E	F
C4532 (CC1812)	(3.60)	(4.90)	12.0 ± 0.30	5.50 ± 0.05	1.75 ± 0.10	8.00 ± 0.10
C5750 (CC2220)	(5.40)	(6.10)				
Symbol Type	G	H	J	K	t	Q
C4532 (CC1812)	2.00 ± 0.05	4.00 ± 0.10	∅ 1.5 $\begin{matrix} +0.10 \\ 0 \end{matrix}$	6.50 max.	0.60 max.	∅ 1.50 min.
C5750 (CC2220)						

* The values in the parentheses () are for reference.

Appendix 7

C0402, C0603, C1005, C1608, C2012, C3216, C3225
 (As for C3225 type, any thickness of the item except 2.5mm)
 (Material : Polystyrene)

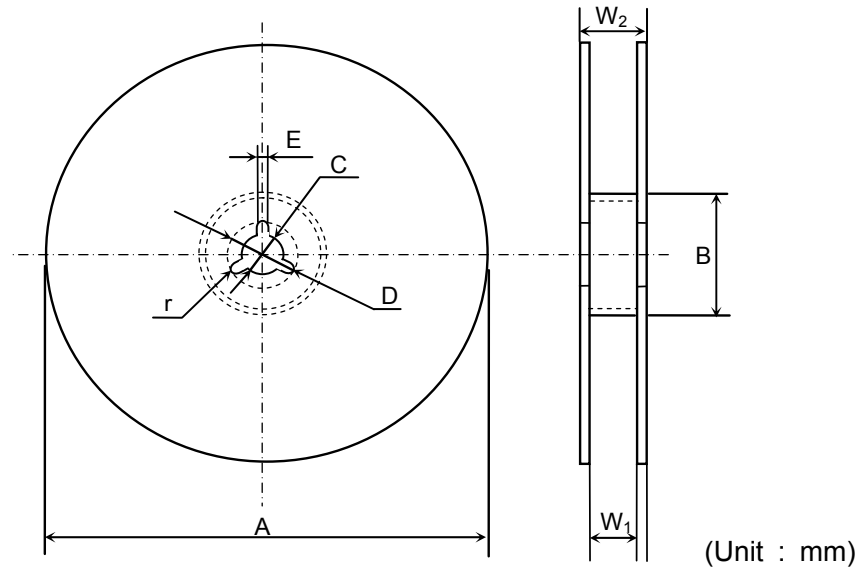

Symbol	A	B	C	D	E	W ₁
Dimension	Ø178 ± 2.0	Ø60 ± 2.0	Ø13 ± 0.5	Ø21 ± 0.8	2.0 ± 0.5	9.0 ± 0.3
Symbol	W ₂	r				
Dimension	13.0 ± 1.4	1.0				

Appendix 8

C3225, C4532, C5750 (As for C3225 type, applied to 2.5mm thickness products)
 (Material : Polystyrene)

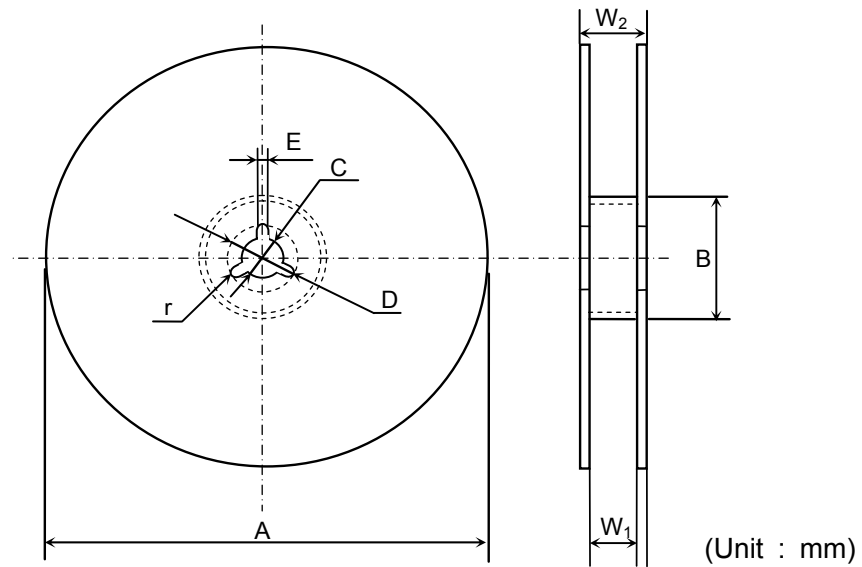

Symbol	A	B	C	D	E	W ₁
Dimension	Ø178 ± 2.0	Ø60 ± 2.0	Ø13 ± 0.5	Ø21 ± 0.8	2.0 ± 0.5	13.0 ± 0.3
Symbol	W ₂	r				
Dimension	17.0 ± 1.4	1.0				

Appendix 9

C0603, C1005, C1608, C2012, C3216, C3225
 (As for C3225 type, any thickness of the item except 2.5mm)
 (Material : Polystyrene)

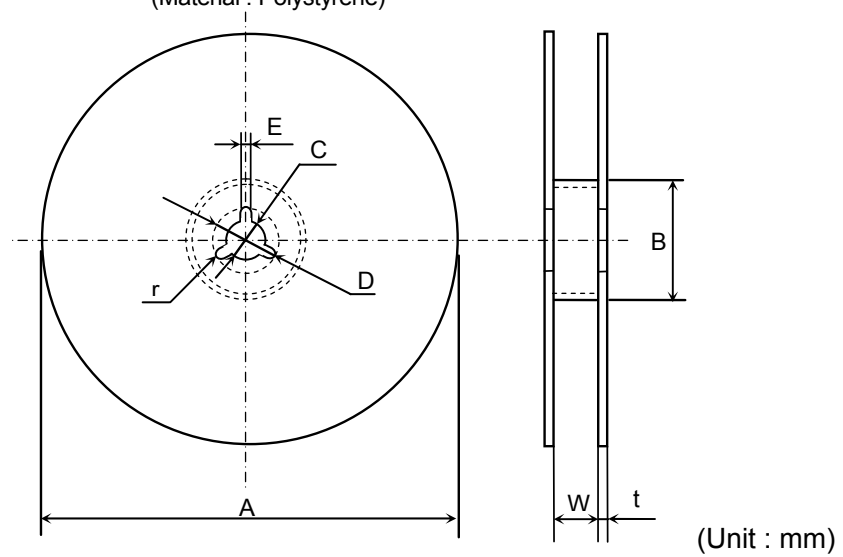

Symbol	A	B	C	D	E	W
Dimension	Ø382 max. (Nominal Ø330)	Ø50 min.	Ø13 ± 0.5	Ø21 ± 0.8	2.0 ± 0.5	10.0 ± 1.5

Symbol	t	r
Dimension	2.0 ± 0.5	1.0

Appendix 10

C3225, C4532, C5750 (As for C3225 type, applied to 2.5mm thickness products)
 (Material : Polystyrene)

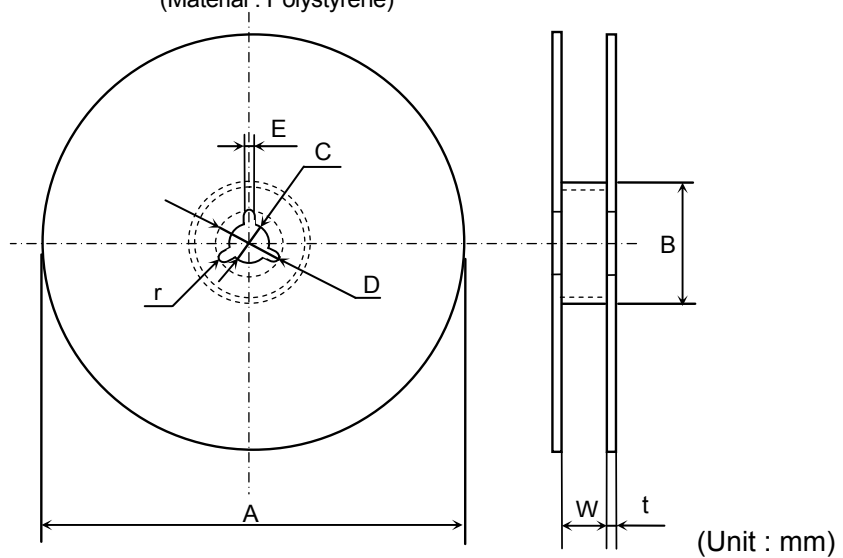

Symbol	A	B	C	D	E	W
Dimension	Ø382 max. (Nominal Ø330)	Ø50 min.	Ø13 ± 0.5	Ø21 ± 0.8	2.0 ± 0.5	14.0 ± 1.5

Symbol	t	r
Dimension	2.0 ± 0.5	1.0