

## Small Signal Zener Diodes

### Features

- Very sharp reverse characteristic
- Low reverse current level
- Available with tighter tolerances
- Very high stability
- Low noise
- Lead (Pb)-free component
- Component in accordance to RoHS 2002/95/EC and WEEE 2002/96/EC

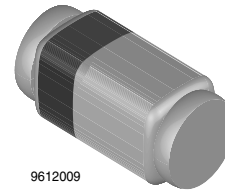

### Applications

- Voltage stabilization

### Mechanical Data

**Case:** QuadromELF Glass case SOD80

**Weight:** approx. 34 mg

#### Packaging Codes/Options:

GS08 / 2.5 k per 7" reel 12.5 k/box

GS18 / 10 k per 13" reel 10 k/box

### Absolute Maximum Ratings

$T_{amb} = 25\text{ }^{\circ}\text{C}$ , unless otherwise specified

Parameter	Test condition	Symbol	Value	Unit
Power dissipation	$R_{thJA} \leq 300\text{ K/W}$	$P_V$	500	mW
Z-current		$I_Z$	$P_V/V_Z$	mA
Junction temperature		$T_j$	175	$^{\circ}\text{C}$
Storage temperature range		$T_{stg}$	- 65 to + 175	$^{\circ}\text{C}$

### Thermal Characteristics

$T_{amb} = 25\text{ }^{\circ}\text{C}$ , unless otherwise specified

Parameter	Test condition	Symbol	Value	Unit
Junction to ambient air	on PC board 50 mm x 50 mm x 1.6 mm	$R_{thJA}$	500	K/W

### Electrical Characteristics

$T_{amb} = 25\text{ }^{\circ}\text{C}$ , unless otherwise specified

Parameter	Test condition	Symbol	Min	Typ.	Max	Unit
Forward voltage	$I_F = 200\text{ mA}$	$V_F$			1.5	V

### Electrical Characteristics

BZT55C..

Partnumber	Zener Voltage <sup>1)</sup>		Dynamic Resistance		Test Current	Temperature Coefficient		Test Current	Reverse Leakage Current		
	$V_Z$ at $I_{ZT}$		$r_{zj}$ at $I_{ZT}$ , $f = 1$ kHz		$I_{ZT}$	TK <sub>VZ</sub>		$I_{ZK}$	$I_R$ at $T_{amb} = 25^\circ C$	$I_R$ at $T_{amb} = 150^\circ C$	at $V_R$
	V		$\Omega$		mA	%K		mA	$\mu A$		V
	min	max				min	max				
BZT55C2V4	2.28	2.56	< 85	< 600	5	- 0.09	- 0.06	1	< 50	< 100	1
BZT55C2V7	2.5	2.9	< 85	< 600	5	- 0.09	- 0.06	1	< 10	< 50	1
BZT55C3V0	2.8	3.2	< 90	< 600	5	- 0.08	- 0.05	1	< 4	< 40	1
BZT55C3V3	3.1	3.5	< 90	< 600	5	- 0.08	- 0.05	1	< 2	< 40	1
BZT55C3V6	3.4	3.8	< 90	< 600	5	- 0.08	- 0.05	1	< 2	< 40	1
BZT55C3V9	3.7	4.1	< 90	< 600	5	- 0.08	- 0.05	1	< 2	< 40	1
BZT55C4V3	4	4.6	< 90	< 600	5	- 0.06	- 0.03	1	< 1	< 20	1
BZT55C4V7	4.4	5	< 80	< 600	5	- 0.05	0.02	1	< 0.5	< 10	1
BZT55C5V1	4.8	5.4	< 60	< 550	5	- 0.02	0.02	1	< 0.1	< 2	1
BZT55C5V6	5.2	6	< 40	< 450	5	- 0.05	0.05	1	< 0.1	< 2	1
BZT55C6V2	5.8	6.6	< 10	< 200	5	0.03	0.06	1	< 0.1	< 2	2
BZT55C6V8	6.4	7.2	< 8	< 150	5	0.03	0.07	1	< 0.1	< 2	3
BZT55C7V5	7	7.9	< 7	< 50	5	0.03	0.07	1	< 0.1	< 2	5
BZT55C8V2	7.7	8.7	< 7	< 50	5	0.03	0.08	1	< 0.1	< 2	6.2
BZT55C9V1 *	8.5	9.6	< 10	< 50	5	0.03	0.09	1	< 0.1	< 2	6.8
BZT55C10 *	9.4	10.6	< 15	< 70	5	0.03	0.1	1	< 0.1	< 2	7.5
BZT55C11 *	10.4	11.6	< 20	< 70	5	0.03	0.11	1	< 0.1	< 2	8.2
BZT55C12 *	11.4	12.7	< 20	< 90	5	0.03	0.11	1	< 0.1	< 2	9.1
BZT55C13 *	12.4	14.1	< 26	< 110	5	0.03	0.11	1	< 0.1	< 2	10
BZT55C15 *	13.8	15.6	< 30	< 110	5	0.03	0.11	1	< 0.1	< 2	11
BZT55C16 *	15.3	17.1	< 40	< 170	5	0.03	0.11	1	< 0.1	< 2	12
BZT55C18 *	16.8	19.1	< 50	< 170	5	0.03	0.11	1	< 0.1	< 2	13
BZT55C20 *	18.8	21.2	< 55	< 220	5	0.03	0.11	1	< 0.1	< 2	15
BZT55C22 *	20.8	23.3	< 55	< 220	5	0.04	0.12	1	< 0.1	< 2	16
BZT55C24 *	22.8	25.6	< 80	< 220	5	0.04	0.12	1	< 0.1	< 2	18
BZT55C27 *	25.1	28.9	< 80	< 220	5	0.04	0.12	1	< 0.1	< 2	20
BZT55C30 *	28	32	< 80	< 220	5	0.04	0.12	1	< 0.1	< 2	22
BZT55C33 *	31	35	< 80	< 220	5	0.04	0.12	1	< 0.1	< 2	24
BZT55C36 *	34	38	< 80	< 220	5	0.04	0.12	1	< 0.1	< 2	27
BZT55C39 *	37	41	< 90	< 500	2.5	0.04	0.12	0.5	< 0.1	< 5	30
BZT55C43 *	40	46	< 90	< 600	2.5	0.04	0.12	0.5	< 0.1	< 5	33
BZT55C47 *	44	50	< 110	< 700	2.5	0.04	0.12	0.5	< 0.1	< 5	36
BZT55C51 *	48	54	< 125	< 700	2.5	0.04	0.12	0.5	< 0.1	< 10	39
BZT55C56 *	52	60	< 135	< 1000	2.5	0.04	0.12	0.5	< 0.1	< 10	43
BZT55C62 *	58	66	< 150	< 1000	2.5	0.04	0.12	0.5	< 0.1	< 10	47
BZT55C68 *	64	72	< 200	< 1000	2.5	0.04	0.12	0.5	< 0.1	< 10	51
BZT55C75 *	70	79	< 250	< 1500	2.5	0.04	0.12	0.5	< 0.1	< 10	56

<sup>1)</sup>  $t_p \leq 10$  ms,  $T/t_p > 1000$

<sup>\*)</sup> Additional measurement of Voltage group 9V1 to 75 at 95 %  $V_{zmin} \leq 35$  nA at  $T_j 25^\circ C$



## Electrical Characteristics

BZT55B..

Partnumber	Zener Voltage <sup>1)</sup>		Dynamic Resistance		Test Current	Temperature Coefficient of Zener Voltage		Test Current	Reverse Leakage Current		
	$V_Z$ at $I_{ZT}$		$r_{zj}$ at $I_{ZT}$ , $f = 1$ kHz			$I_{ZT}$	TK <sub>VZ</sub>		$I_{ZK}$	$I_R$ at $T_{amb} = 25^\circ C$	$I_R$ at $T_{amb} = 150^\circ C$
	min	max	$\Omega$	$\Omega$	mA		%/K	%/K		mA	$\mu A$
BZT55B2V4	2.35	2.45	< 85	< 600	5	- 0.09	- 0.06	1	< 50	< 100	1
BZT55B2V7	2.64	2.76	< 85	< 600	5	- 0.09	- 0.06	1	< 10	< 50	1
BZT55B3V0	2.94	3.06	< 90	< 600	5	- 0.08	- 0.05	1	< 4	< 40	1
BZT55B3V3	3.24	3.36	< 90	< 600	5	- 0.08	- 0.05	1	< 2	< 40	1
BZT55B3V6	3.52	3.68	< 90	< 600	5	- 0.08	- 0.05	1	< 2	< 40	1
BZT55B3V9	3.82	3.98	< 90	< 600	5	- 0.08	- 0.05	1	< 2	< 40	1
BZT55B4V3	4.22	4.38	< 90	< 600	5	- 0.06	- 0.03	1	< 1	< 20	1
BZT55B4V7	4.6	4.8	< 80	< 600	5	- 0.05	0.02	1	< 0.5	< 10	1
BZT55B5V1	5	5.2	< 60	< 550	5	- 0.02	0.02	1	< 0.1	< 2	1
BZT55B5V6	5.48	5.72	< 40	< 450	5	- 0.05	0.05	1	< 0.1	< 2	1
BZT55B6V2	6.08	6.32	< 10	< 200	5	0.03	0.06	1	< 0.1	< 2	2
BZT55B6V8	6.66	6.94	< 8	< 150	5	0.03	0.07	1	< 0.1	< 2	3
BZT55B7V5	7.35	7.65	< 7	< 50	5	0.03	0.07	1	< 0.1	< 2	5
BZT55B8V2	8.04	8.36	< 7	< 50	5	0.03	0.08	1	< 0.1	< 2	6.2
BZT55B9V1 *	8.92	9.28	< 10	< 50	5	0.03	0.09	1	< 0.1	< 2	6.8
BZT55B10 *	9.8	10.2	< 15	< 70	5	0.03	0.1	1	< 0.1	< 2	7.5
BZT55B11 *	10.78	11.22	< 20	< 70	5	0.03	0.11	1	< 0.1	< 2	8.2
BZT55B12 *	11.76	12.24	< 20	< 90	5	0.03	0.11	1	< 0.1	< 2	9.1
BZT55B13 *	12.74	13.26	< 26	< 110	5	0.03	0.11	1	< 0.1	< 2	10
BZT55B15 *	14.7	15.3	< 30	< 110	5	0.03	0.11	1	< 0.1	< 2	11
BZT55B16 *	15.7	16.3	< 40	< 170	5	0.03	0.11	1	< 0.1	< 2	12
BZT55B18 *	17.64	18.36	< 50	< 170	5	0.03	0.11	1	< 0.1	< 2	13
BZT55B20 *	19.6	20.4	< 55	< 220	5	0.03	0.11	1	< 0.1	< 2	15
BZT55B22 *	21.55	22.45	< 55	< 220	5	0.04	0.12	1	< 0.1	< 2	16
BZT55B24 *	23.5	24.5	< 80	< 220	5	0.04	0.12	1	< 0.1	< 2	18
BZT55B27 *	26.4	27.6	< 80	< 220	5	0.04	0.12	1	< 0.1	< 2	20
BZT55B30 *	29.4	30.6	< 80	< 220	5	0.04	0.12	1	< 0.1	< 2	22
BZT55B33 *	32.4	33.6	< 80	< 220	5	0.04	0.12	1	< 0.1	< 2	24
BZT55B36 *	35.3	36.7	< 80	< 220	5	0.04	0.12	1	< 0.1	< 2	27
BZT55B39 *	38.2	39.8	< 90	< 500	2.5	0.04	0.12	1	< 0.1	< 5	30
BZT55B43 *	42.1	43.9	< 90	< 600	2.5	0.04	0.12	0.5	< 0.1	< 5	33
BZT55B47 *	46.1	47.9	< 110	< 700	2.5	0.04	0.12	0.5	< 0.1	< 5	36
BZT55B51 *	50	52	< 125	< 700	2.5	0.04	0.12	0.5	< 0.1	< 10	39
BZT55B56 *	54.9	57.1	< 135	< 1000	2.5	0.04	0.12	0.5	< 0.1	< 10	43
BZT55B62 *	60.8	63.2	< 150	< 1000	2.5	0.04	0.12	0.5	< 0.1	< 10	47
BZT55B68 *	66.6	69.4	< 200	< 1000	2.5	0.04	0.12	0.5	< 0.1	< 10	51
BZT55B75 *	73.5	76.5	< 250	< 1500	2.5	0.04	0.12	0.5	< 0.1	< 10	56

<sup>1)</sup>  $t_p \leq 10$  ms,  $T/t_p > 1000$

<sup>2)</sup> Additional measurement of Voltage group 9V1 to 75 at 95 %  $V_{zmin} \leq 35$  nA at  $T_j 25^\circ C$

## Typical Characteristics

$T_{amb} = 25\text{ }^{\circ}\text{C}$ , unless otherwise specified

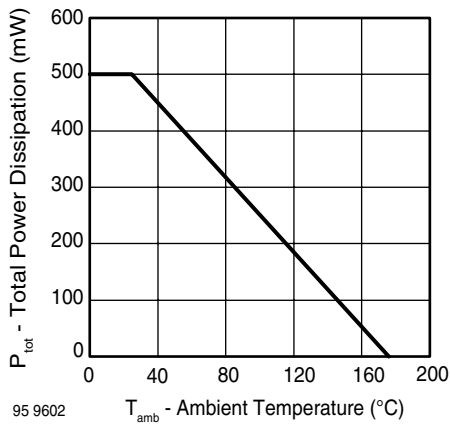

Figure 1. Total Power Dissipation vs. Ambient Temperature

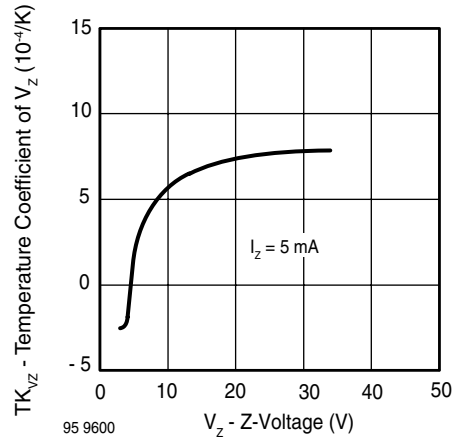

Figure 4. Temperature Coefficient of  $V_z$  vs. Z-Voltage

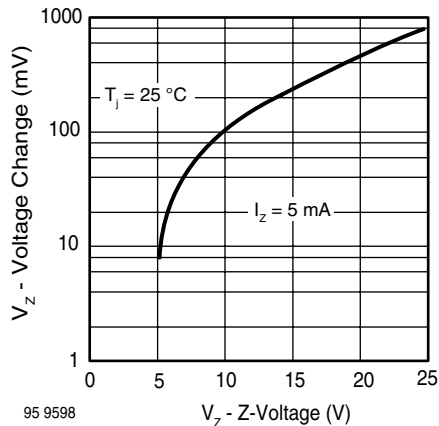

Figure 2. Typical Change of Working Voltage under Operating Conditions at  $T_{amb}=25\text{ }^{\circ}\text{C}$

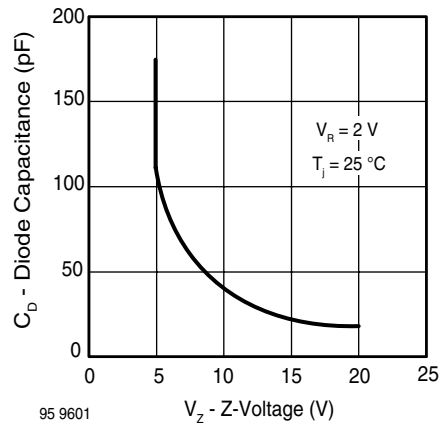

Figure 5. Diode Capacitance vs. Z-Voltage

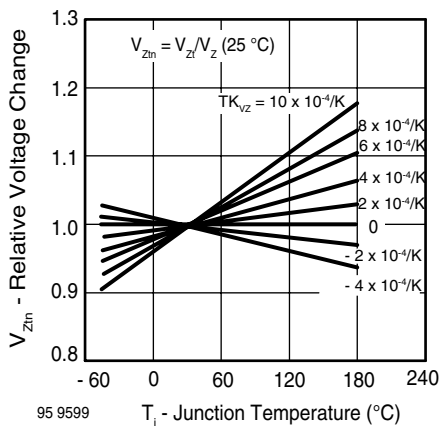

Figure 3. Typical Change of Working Voltage vs. Junction Temperature

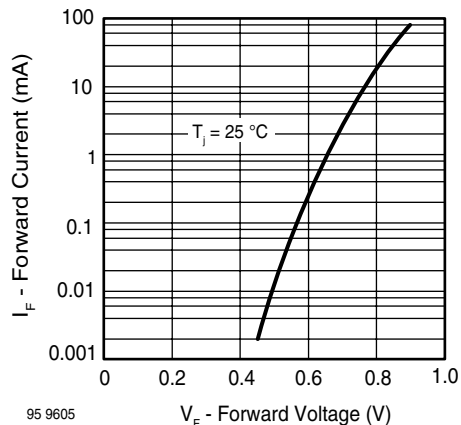

Figure 6. Forward Current vs. Forward Voltage

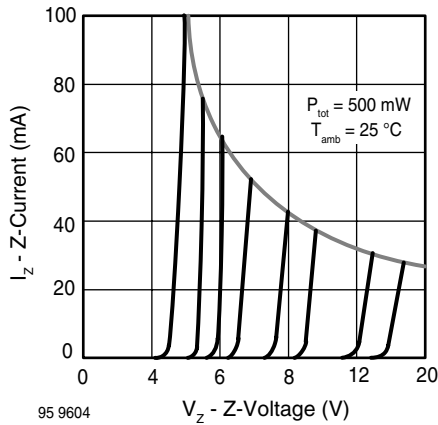

Figure 7. Z-Current vs. Z-Voltage

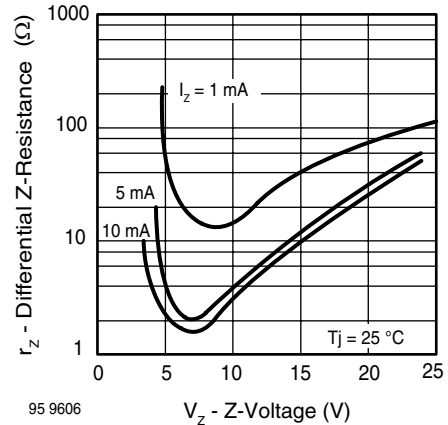

Figure 9. Differential Z-Resistance vs. Z-Voltage

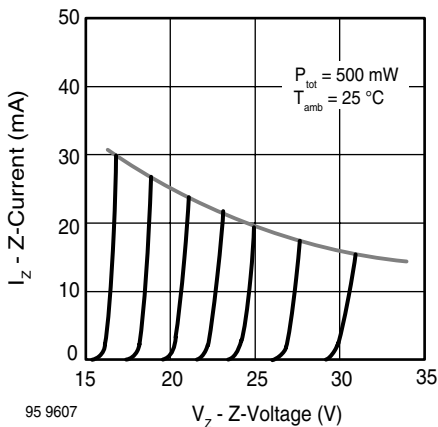

Figure 8. Z-Current vs. Z-Voltage

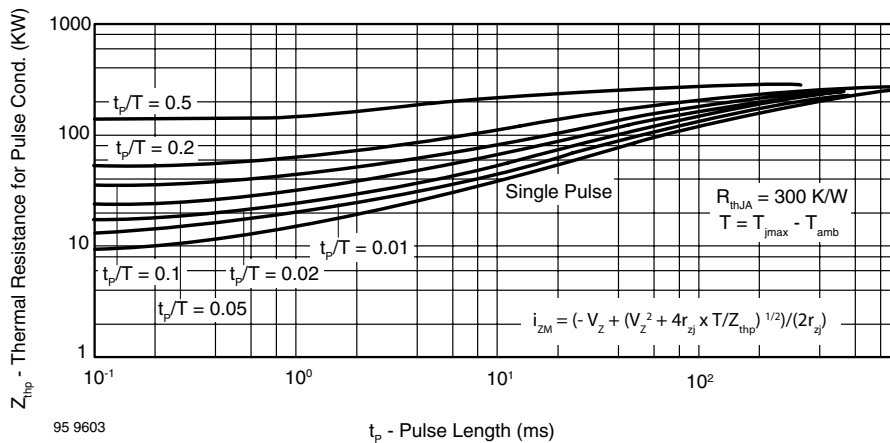

Figure 10. Thermal Response

# BZT55-Series

Vishay Semiconductors



## Package Dimensions in mm (Inches)

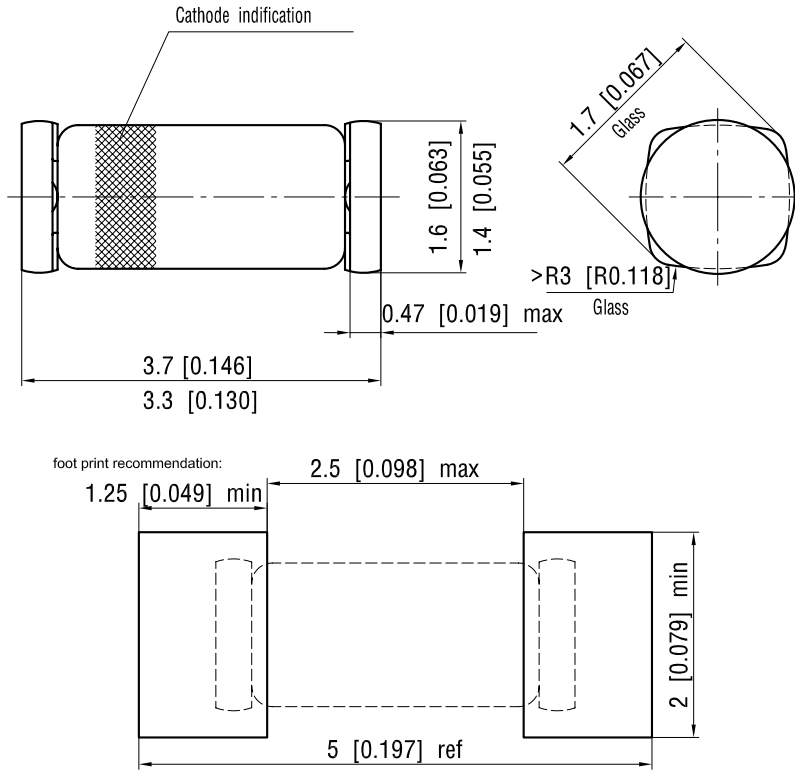

Document no.: 6.560-5006.01-4  
Rev. 10 - Date: 30.August.2004

12071



## Ozone Depleting Substances Policy Statement

It is the policy of Vishay Semiconductor GmbH to

1. Meet all present and future national and international statutory requirements.
2. Regularly and continuously improve the performance of our products, processes, distribution and operating systems with respect to their impact on the health and safety of our employees and the public, as well as their impact on the environment.

It is particular concern to control or eliminate releases of those substances into the atmosphere which are known as ozone depleting substances (ODSs).

The Montreal Protocol (1987) and its London Amendments (1990) intend to severely restrict the use of ODSs and forbid their use within the next ten years. Various national and international initiatives are pressing for an earlier ban on these substances.

Vishay Semiconductor GmbH has been able to use its policy of continuous improvements to eliminate the use of ODSs listed in the following documents.

1. Annex A, B and list of transitional substances of the Montreal Protocol and the London Amendments respectively
2. Class I and II ozone depleting substances in the Clean Air Act Amendments of 1990 by the Environmental Protection Agency (EPA) in the USA
3. Council Decision 88/540/EEC and 91/690/EEC Annex A, B and C (transitional substances) respectively.

Vishay Semiconductor GmbH can certify that our semiconductors are not manufactured with ozone depleting substances and do not contain such substances.

We reserve the right to make changes to improve technical design  
and may do so without further notice.

Parameters can vary in different applications. All operating parameters must be validated for each customer application by the customer. Should the buyer use Vishay Semiconductors products for any unintended or unauthorized application, the buyer shall indemnify Vishay Semiconductors against all claims, costs, damages, and expenses, arising out of, directly or indirectly, any claim of personal damage, injury or death associated with such unintended or unauthorized use.

Vishay Semiconductor GmbH, P.O.B. 3535, D-74025 Heilbronn, Germany



## Disclaimer

All product specifications and data are subject to change without notice.

Vishay Intertechnology, Inc., its affiliates, agents, and employees, and all persons acting on its or their behalf (collectively, "Vishay"), disclaim any and all liability for any errors, inaccuracies or incompleteness contained herein or in any other disclosure relating to any product.

Vishay disclaims any and all liability arising out of the use or application of any product described herein or of any information provided herein to the maximum extent permitted by law. The product specifications do not expand or otherwise modify Vishay's terms and conditions of purchase, including but not limited to the warranty expressed therein, which apply to these products.

No license, express or implied, by estoppel or otherwise, to any intellectual property rights is granted by this document or by any conduct of Vishay.

The products shown herein are not designed for use in medical, life-saving, or life-sustaining applications unless otherwise expressly indicated. Customers using or selling Vishay products not expressly indicated for use in such applications do so entirely at their own risk and agree to fully indemnify Vishay for any damages arising or resulting from such use or sale. Please contact authorized Vishay personnel to obtain written terms and conditions regarding products designed for such applications.

Product names and markings noted herein may be trademarks of their respective owners.