

Low capacitance small signal Schottky diodes

Features

- Low leakage current losses
- Negligible switching losses
- Low forward and reverse recovery times
- Extremely fast switching
- Surface mount device
- Low capacitance diode

Description

The BAT41 series uses 100 V Schottky barrier diodes packaged in SOD-123, SOD-323, SOD-523, SOT-323, or SOT-666. This series is specially suited for switching mode with low I_F losses

Table 1. Device summary

Symbol	Value
I_F	200 mA
V_{RRM}	100 V
C(typ)	3 pF
T_j (max)	150 °C

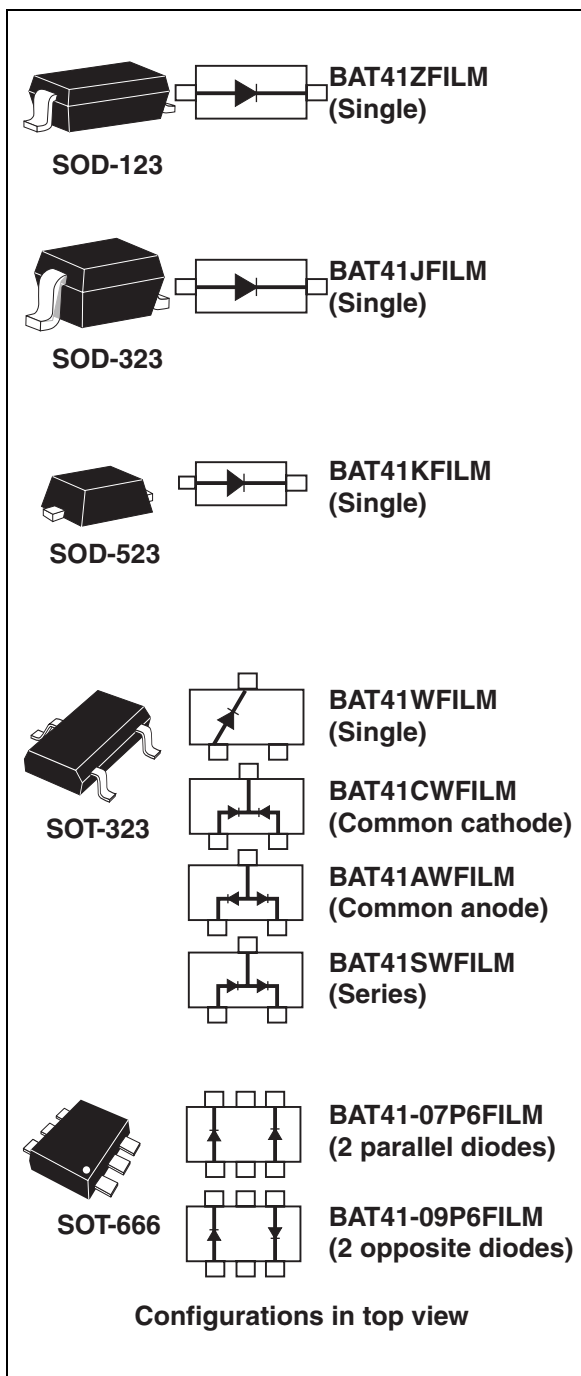

1 Characteristics

Table 2. Absolute ratings (limiting values at $T_j = 25\text{ °C}$, unless otherwise specified)

Symbol	Parameter	Value	Unit	
V_{RRM}	Repetitive peak reverse voltage	100	V	
I_F	Continuous forward current	200	mA	
I_{FSM}	Surge non repetitive forward current	$t_p = 10\text{ ms}$ Sinusoidal	1	A
T_{stg}	Storage temperature range	-65 to +150	°C	
T_j	Maximum operating junction temperature	150	°C	

Table 3. Thermal parameters

Symbol	Parameter	Value	Unit	
$R_{th(j-a)}$	Junction to ambient ⁽¹⁾	SOD-123	500	°C/W
		SOT-323, SOD-323	550	
		SOD-523, SOT-666	600	

1. Epoxy printed circuit board with recommended pad layout

Table 4. Static electrical characteristics

Symbol	Parameter	Test conditions	Min.	Typ.	Max.	Unit	
$I_R^{(1)}$	Reverse leakage current	$T_j = 25\text{ °C}$	$V_R = 50\text{ V}$		0.1	μA	
		$T_j = 100\text{ °C}$			20		
$V_F^{(2)}$	Forward voltage drop	$T_j = 25\text{ °C}$	$I_F = 1\text{ mA}$		400	450	mV
			$I_F = 200\text{ mA}$			1000	

1. Pulse test: $t_p = 5\text{ ms}$, $\delta < 2\%$

2. Pulse test: $t_p = 380\text{ }\mu\text{s}$, $\delta < 2\%$

Table 5. Dynamic characteristics

Symbol	Parameter	Test conditions	Min.	Typ.	Max.	Unit
C	Diode capacitance	$V_R = 1\text{ V}$, $F = 1\text{ MHz}$		3	10	pF

Figure 1. Average forward power dissipation versus average forward current

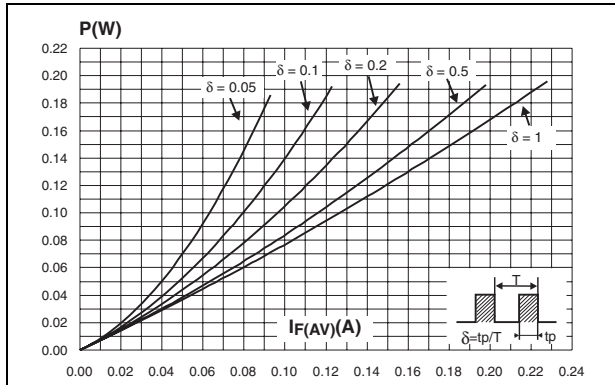

Figure 2. Average forward current versus ambient temperature (delta = 1)

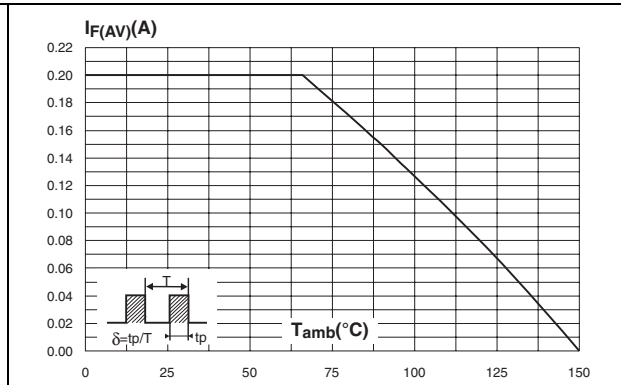

Figure 3. Reverse leakage current versus reverse applied voltage (typical values)

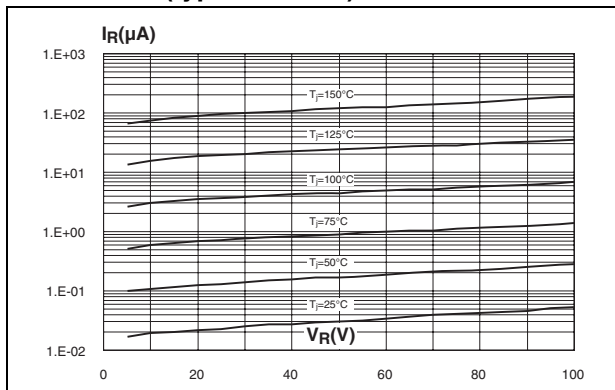

Figure 4. Reverse leakage current versus junction temperature (typical values)

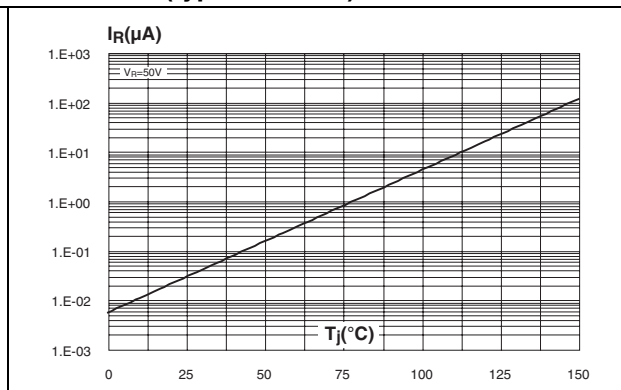

Figure 5. Junction capacitance versus reverse applied voltage (typical values)

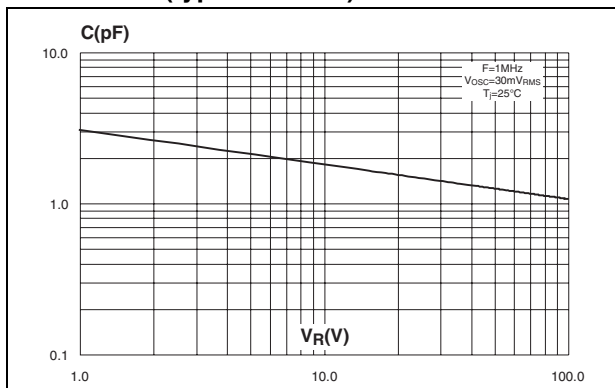

Figure 6. Forward voltage drop versus forward current (typical values)

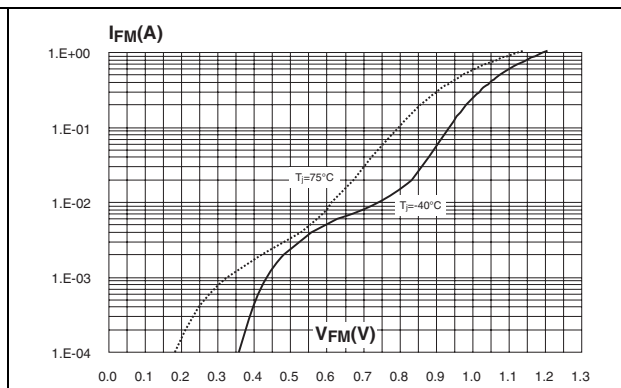

Figure 7. Forward voltage drop versus forward current (typical values)

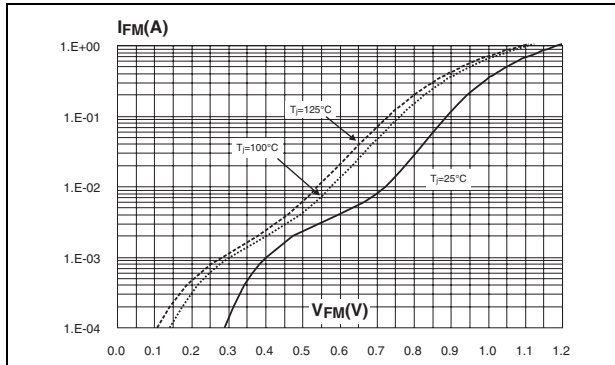

Figure 8. Variation of thermal impedance junction to ambient versus pulse duration

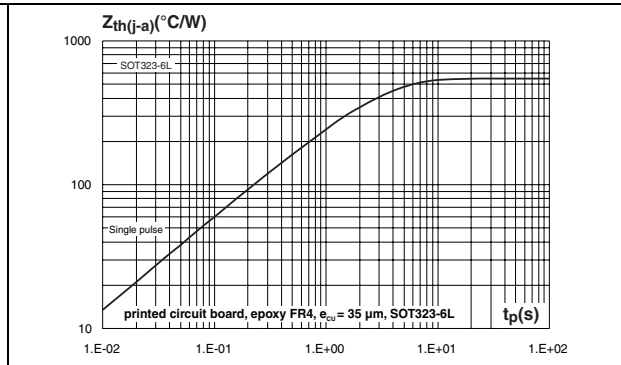

Figure 9. Relative variation of thermal impedance junction to ambient versus pulse duration

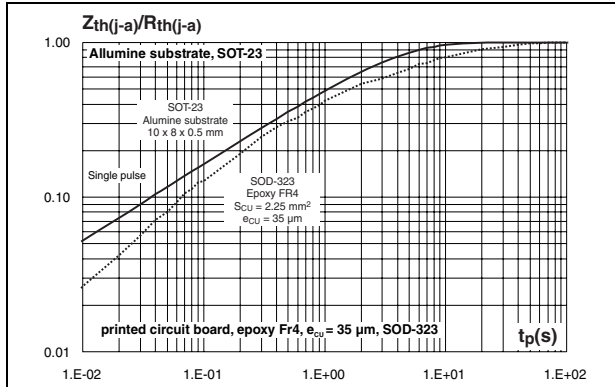

Figure 10. Relative variation of thermal impedance junction to ambient versus pulse duration

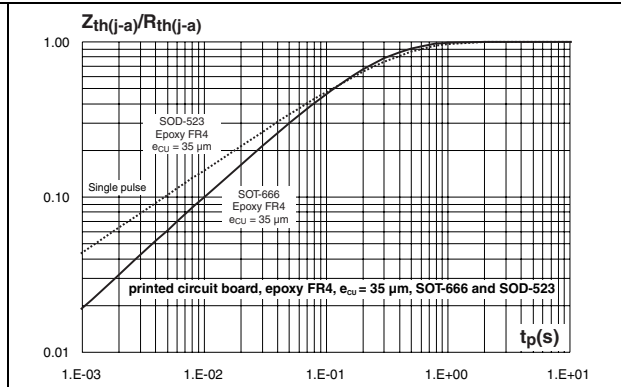
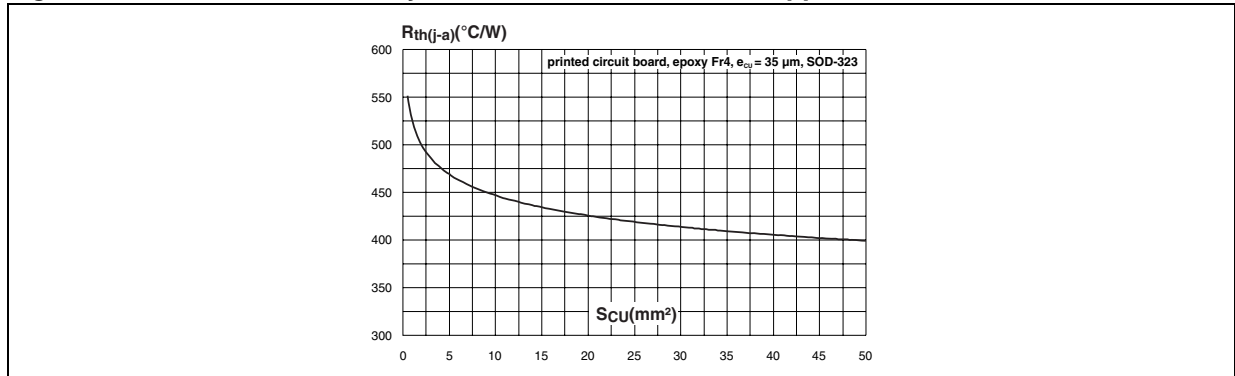
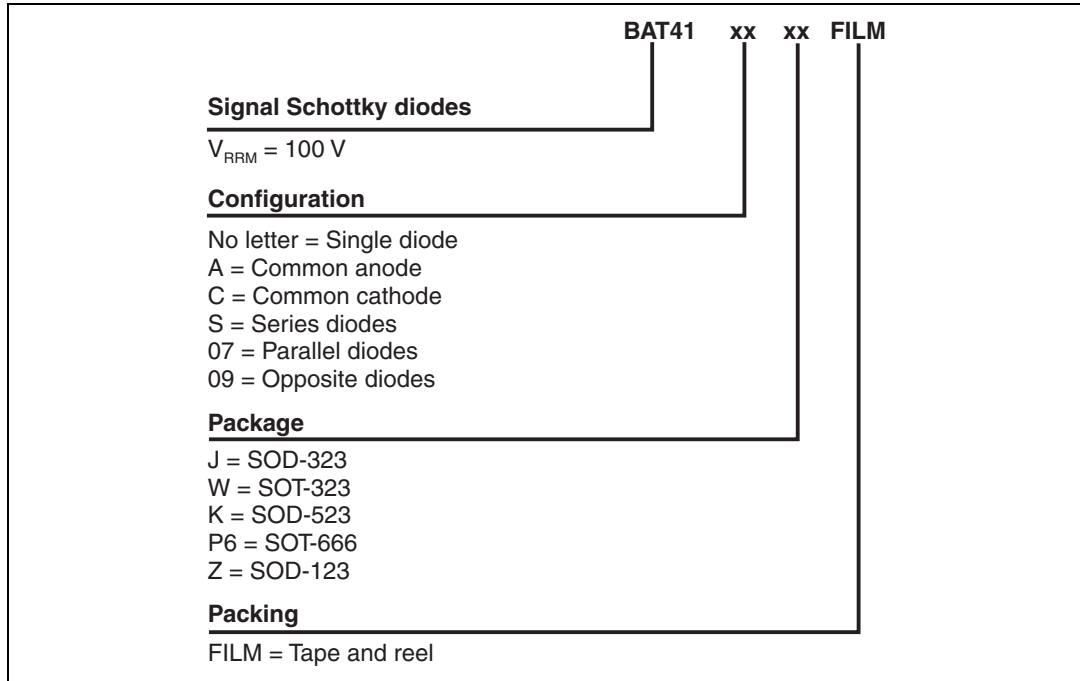

Figure 11. Thermal resistance junction to ambient versus copper surface under each lead



2 Ordering information scheme

Figure 12. Ordering information scheme



3 Package information

- Epoxy meets UL94, V0
- Lead-free packages

In order to meet environmental requirements, ST offers these devices in different grades of ECOPACK® packages, depending on their level of environmental compliance. ECOPACK® specifications, grade definitions and product status are available at: www.st.com. ECOPACK® is an ST trademark.

Table 6. SOD-123 dimensions

Ref.	Dimensions			
	Millimeters		Inches	
	Min.	Max.	Min.	Max.
A		1.45		0.057
A1	0	0.1	0	0.004
A2	0.85	1.35	0.033	0.053
b	0.55 Typ.		0.022 Typ.	
c	0.15 Typ.		0.039 Typ.	
D	2.55	2.85	0.1	0.112
E	1.4	1.7	0.055	0.067
G	0.25		0.01	
H	3.55	3.95	0.14	0.156

Figure 13. SOD-123 footprint (dimensions in mm)

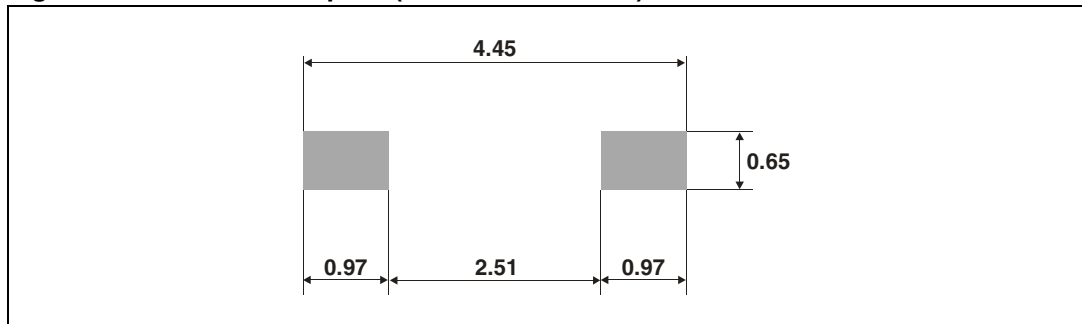

Table 7. SOD-323 dimensions

Ref.	Dimensions			
	Millimeters		Inches	
	Min.	Max.	Min.	Max.
A		1.17		0.046
A1	0	0.1	0	0.004
b	0.25	0.44	0.01	0.017
c	0.1	0.25	0.004	0.01
D	1.52	1.8	0.06	0.071
E	1.11	1.45	0.044	0.057
H	2.3	2.7	0.09	0.106
L	0.1	0.46	0.004	0.02
Q1	0.1	0.41	0.004	0.016

Figure 14. SOD-323 footprint (dimensions in mm)

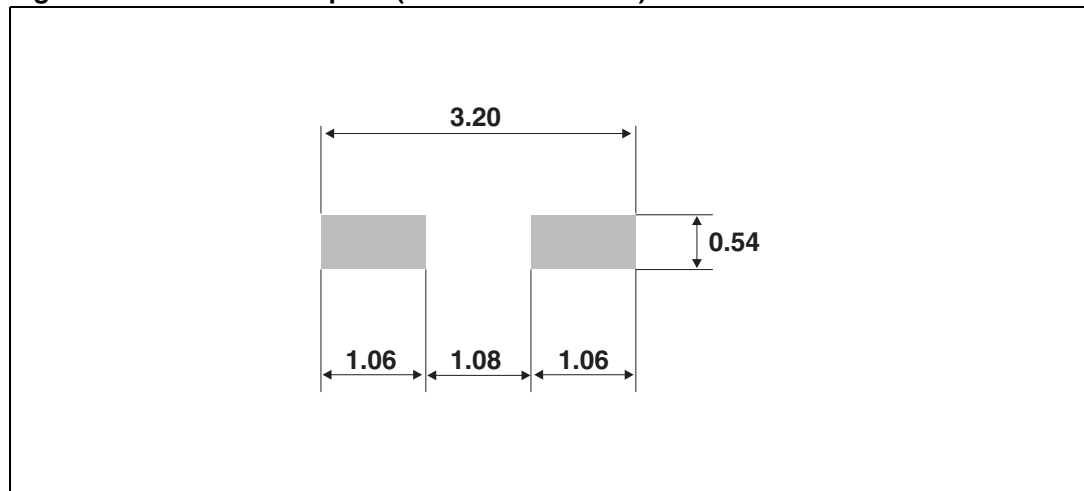

Table 8. SOD-523 dimensions

Ref.	Dimensions					
	Millimeters			Inches		
	Min.	Typ.	Max.	Min.	Typ.	Max.
A	0.50	0.60	0.70	0.020	0.024	0.028
E	1.50	1.60	1.70	0.059	0.063	0.067
E1	1.10	1.20	1.30	0.043	0.047	0.051
D	0.70	0.80	0.90	0.028	0.031	0.035
b	0.25		0.35	0.010		0.014
c	0.07		0.20	0.003		0.008
L	0.15	0.20	0.25	0.006	0.008	0.010
L1	0.05		0.20	0.002		0.008

Figure 15. SOD-523 footprint (dimensions in mm)

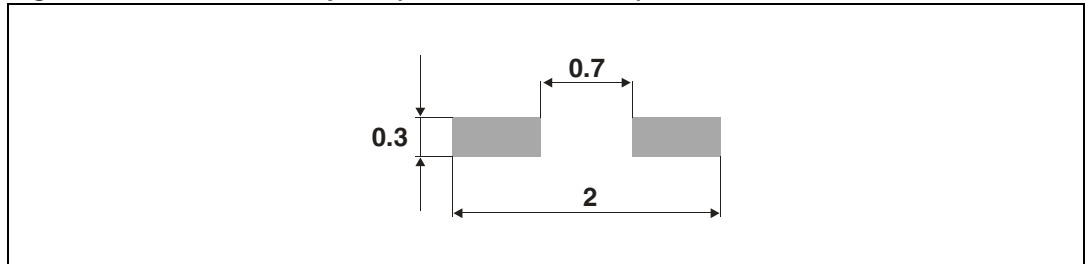

Table 9. SOT-323 dimensions

Ref.	Dimensions					
	Millimeters			Inches		
	Min.	Typ.	Max.	Min.	Typ.	Max.
A	0.8		1.1	0.031		0.043
A1	0.0		0.1	0.0		0.004
b	0.25		0.4	0.010		0.016
c	0.1		0.26	0.004		0.010
D	1.8	2.0	2.2	0.071	0.079	0.086
E	1.15	1.25	1.35	0.045	0.049	0.053
e		0.65			0.026	
H	1.8	2.1	2.4	0.071	0.083	0.094
L	0.1	0.2	0.3	0.004	0.008	0.012
q	0		30°	0		30°

Figure 16. SOT-323 footprint (dimensions in mm)

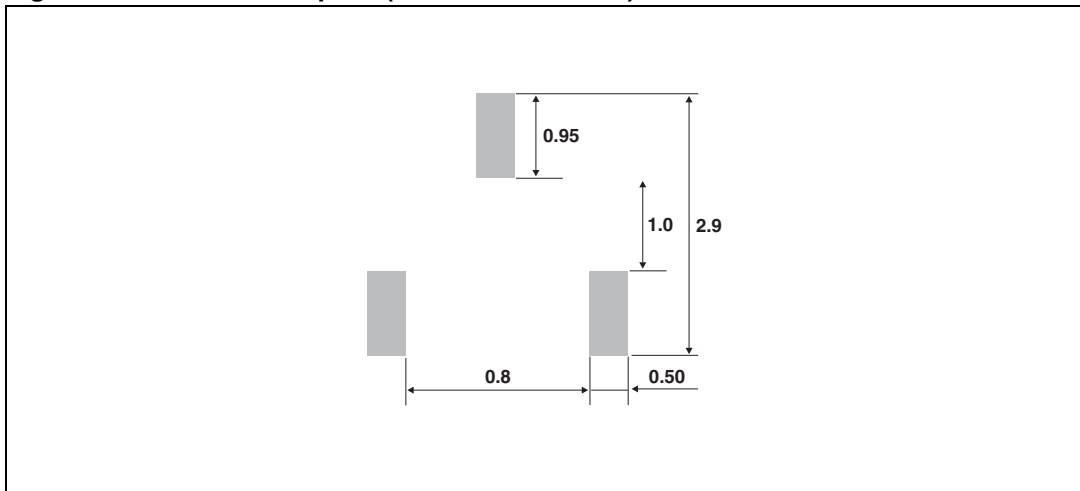
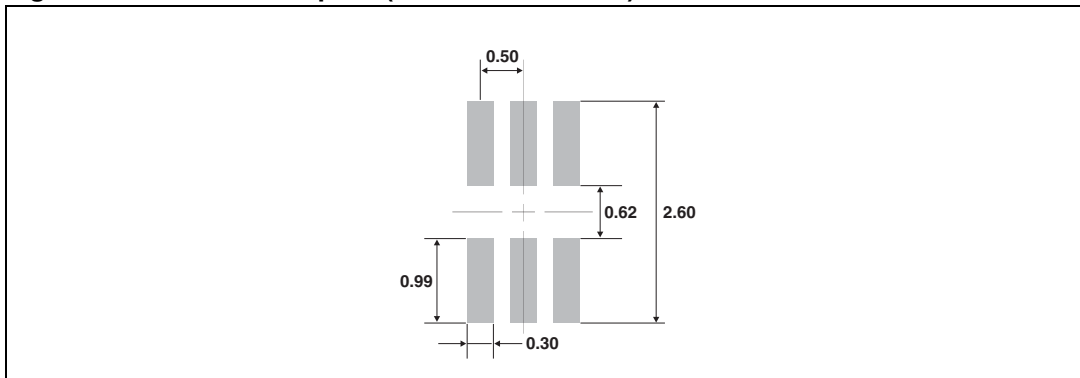

Table 10. SOT-666 dimensions

Ref.	Dimensions					
	Millimeters			Inches		
	Min.	Typ.	Max.	Min.	Typ.	Max.
A	0.45		0.60	0.018		0.024
A3	0.08		0.18	0.003		0.007
b	0.17		0.34	0.007		0.013
b1	0.19	0.27	0.34	0.007	0.011	0.013
D	1.50		1.70	0.059		0.067
E	1.50		1.70	0.059		0.067
E1	1.10		1.30	0.043		0.051
e		0.50			0.020	
L1		0.19			0.007	
L2	0.10		0.30	0.004		0.012
L3		0.10			0.004	

Figure 17. SOT-666 footprint (dimensions in mm)



4 Ordering information

Table 11. Ordering information

Order code	Marking	Package	Weight	Base qty	Delivery mode
BAT41ZFILM	Z41	SOD-123 Single	10 mg	3000	Tape and reel
BAT41WFILM	B41	SOT-323 Single	6 mg	3000	Tape and reel
BAT41SWFILM	S41	SOT-323 Series	6 mg	3000	Tape and reel
BAT41CWFILM	C41	SOT-323 Common cathode	6 mg	3000	Tape and reel
BAT41AWFILM	A41	SOT-323 Common anode	6 mg	3000	Tape and reel
BAT41JFILM	41	SOD-323 Single	5 mg	3000	Tape and reel
BAT41KFILM	41	SOD-523 Single	1.4 mg	3000	Tape and reel
BAT41-09P6FILM	Q1	SOT-666 Opposite	2.9 mg	3000	Tape and reel
BAT41-07P6FILM	P1	SOT-666 Parallel	2.9 mg	3000	Tape and reel

5 Revision history

Table 12. Document revision history

Date	Revision	Changes
08-Aug-2006	1	Initial release.
12-Oct-2009	2	Updated Table 8 quote "L1" from 0.10 to 0.05.

Please Read Carefully:

Information in this document is provided solely in connection with ST products. STMicroelectronics NV and its subsidiaries ("ST") reserve the right to make changes, corrections, modifications or improvements, to this document, and the products and services described herein at any time, without notice.

All ST products are sold pursuant to ST's terms and conditions of sale.

Purchasers are solely responsible for the choice, selection and use of the ST products and services described herein, and ST assumes no liability whatsoever relating to the choice, selection or use of the ST products and services described herein.

No license, express or implied, by estoppel or otherwise, to any intellectual property rights is granted under this document. If any part of this document refers to any third party products or services it shall not be deemed a license grant by ST for the use of such third party products or services, or any intellectual property contained therein or considered as a warranty covering the use in any manner whatsoever of such third party products or services or any intellectual property contained therein.

UNLESS OTHERWISE SET FORTH IN ST'S TERMS AND CONDITIONS OF SALE ST DISCLAIMS ANY EXPRESS OR IMPLIED WARRANTY WITH RESPECT TO THE USE AND/OR SALE OF ST PRODUCTS INCLUDING WITHOUT LIMITATION IMPLIED WARRANTIES OF MERCHANTABILITY, FITNESS FOR A PARTICULAR PURPOSE (AND THEIR EQUIVALENTS UNDER THE LAWS OF ANY JURISDICTION), OR INFRINGEMENT OF ANY PATENT, COPYRIGHT OR OTHER INTELLECTUAL PROPERTY RIGHT.

UNLESS EXPRESSLY APPROVED IN WRITING BY AN AUTHORIZED ST REPRESENTATIVE, ST PRODUCTS ARE NOT RECOMMENDED, AUTHORIZED OR WARRANTED FOR USE IN MILITARY, AIR CRAFT, SPACE, LIFE SAVING, OR LIFE SUSTAINING APPLICATIONS, NOR IN PRODUCTS OR SYSTEMS WHERE FAILURE OR MALFUNCTION MAY RESULT IN PERSONAL INJURY, DEATH, OR SEVERE PROPERTY OR ENVIRONMENTAL DAMAGE. ST PRODUCTS WHICH ARE NOT SPECIFIED AS "AUTOMOTIVE GRADE" MAY ONLY BE USED IN AUTOMOTIVE APPLICATIONS AT USER'S OWN RISK.

Resale of ST products with provisions different from the statements and/or technical features set forth in this document shall immediately void any warranty granted by ST for the ST product or service described herein and shall not create or extend in any manner whatsoever, any liability of ST.

ST and the ST logo are trademarks or registered trademarks of ST in various countries.

Information in this document supersedes and replaces all information previously supplied.

The ST logo is a registered trademark of STMicroelectronics. All other names are the property of their respective owners.

© 2009 STMicroelectronics - All rights reserved

STMicroelectronics group of companies

Australia - Belgium - Brazil - Canada - China - Czech Republic - Finland - France - Germany - Hong Kong - India - Israel - Italy - Japan - Malaysia - Malta - Morocco - Philippines - Singapore - Spain - Sweden - Switzerland - United Kingdom - United States of America

www.st.com