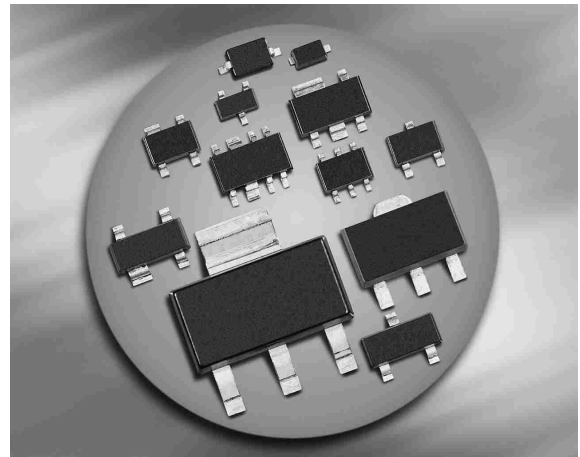
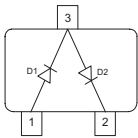
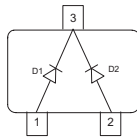
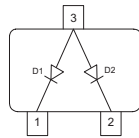
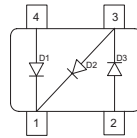

Silicon PIN Diode

- RF switch, RF attenuator for frequencies above 10 MHz
- Low distortion faktor
- Long-term stability of electrical characteristics
- Pb-free (RoHS compliant) package
- Qualified according AEC Q101

BAR14-1

BAR15-1

BAR16-1

BAR61

Type	Package	Configuration	L_S (nH)	Marking
BAR14-1	SOT23	series	1.8	L7s
BAR15-1	SOT23	common cathode	1.8	L8s
BAR16-1	SOT23	common anode	1.8	L9s
BAR61	SOT143	PI element	2	61s

Maximum Ratings at $T_A = 25^\circ\text{C}$, unless otherwise specified

Parameter	Symbol	Value	Unit
Diode reverse voltage	V_R	100	V
Forward current	I_F	140	mA
Total power dissipation $T_S \leq 65^\circ\text{C}$	P_{tot}	250	mW
Junction temperature	T_j	150	°C
Operating temperature range	T_{op}	-55 ... 125	
Storage temperature	T_{stg}	-55 ... 150	

Thermal Resistance

Parameter	Symbol	Value	Unit
Junction - soldering point ¹⁾	R_{thJS}	≤ 340	K/W

¹⁾For calculation of R_{thJA} please refer to Application Note Thermal Resistance

Electrical Characteristics at $T_A = 25^\circ\text{C}$, unless otherwise specified

Parameter	Symbol	Values			Unit
		min.	typ.	max.	
DC Characteristics					
Reverse current $V_R = 50\text{ V}$ $V_R = 100\text{ V}$	I_R	-	-	100 1000	nA
Forward voltage $I_F = 100\text{ mA}$	V_F	-	1.05	1.25	V
AC Characteristics					
Diode capacitance $V_R = 0\text{ V}, f = 100\text{ MHz}$ $V_R = 50\text{ V}, f = 1\text{ MHz}$	C_T	-	0.2 0.25	0.5 0.5	pF
Zero bias conductance $V_R = 0\text{ V}, f = 100\text{ MHz}$	g_P	-	50	100	μS
Forward resistance $I_F = 0.01\text{ mA}, f = 100\text{ MHz}$ $I_F = 0.1\text{ mA}, f = 100\text{ MHz}$ $I_F = 1\text{ mA}, f = 100\text{ MHz}$ $I_F = 10\text{ mA}, f = 100\text{ MHz}$	r_f	-	2600 300 35 5.5	4200 - 85 12	Ω
Charge carrier life time $I_F = 10\text{ mA}, I_R = 6\text{ mA}$, measured at $I_R = 3\text{ mA}$, $R_L = 100\ \Omega$	τ_{rr}	700	1000	-	ns
I-region width	W_I	-	146	-	μm

Diode capacitance $C_T = f(V_R)$

$f =$ Parameter

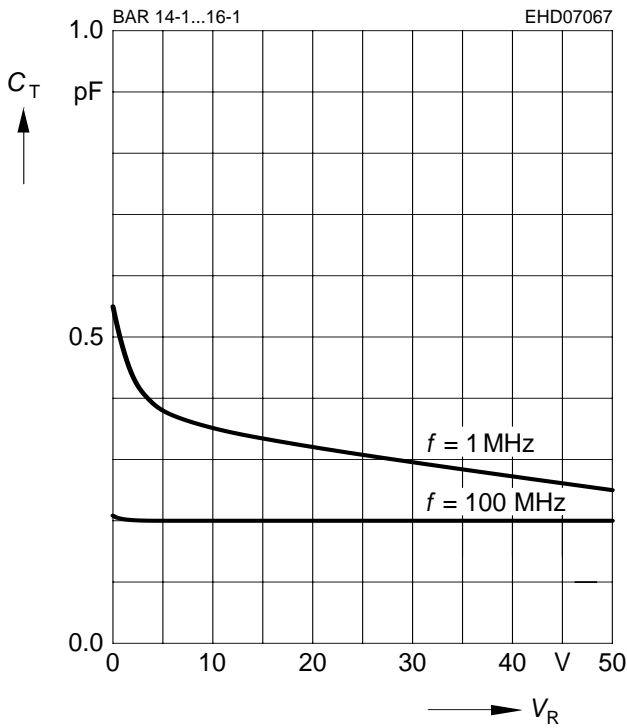

Forward resistance $r_f = f(I_F)$

$f = 100\text{MHz}$

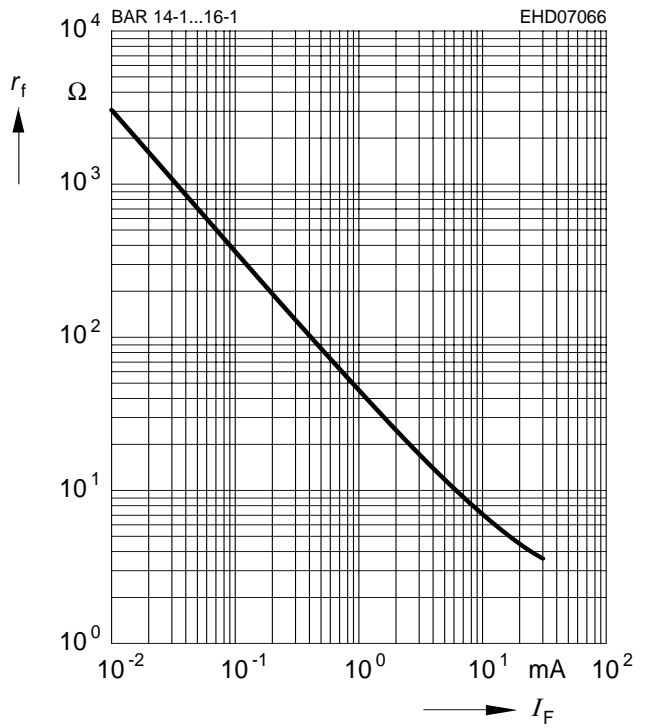

Forward current $I_F = f(V_F)$

$T_A = 25^\circ\text{C}$

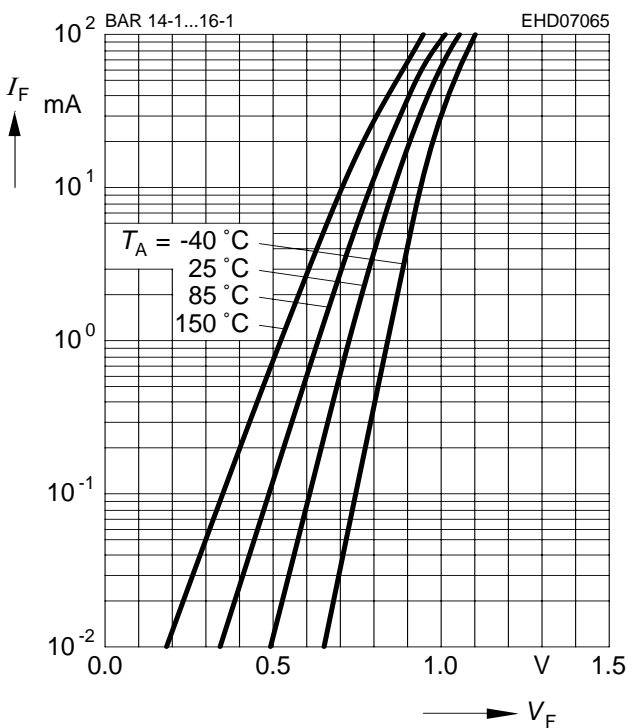

Forward current $I_F = f(T_S)$

BAR14-1, BAR15-1, BAR16-1

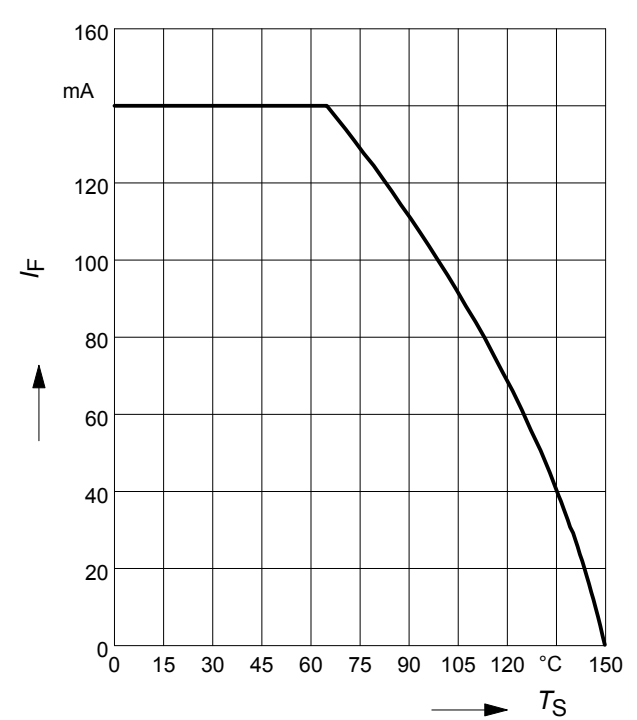

Application circuit for attenuation networks with diode BAR61

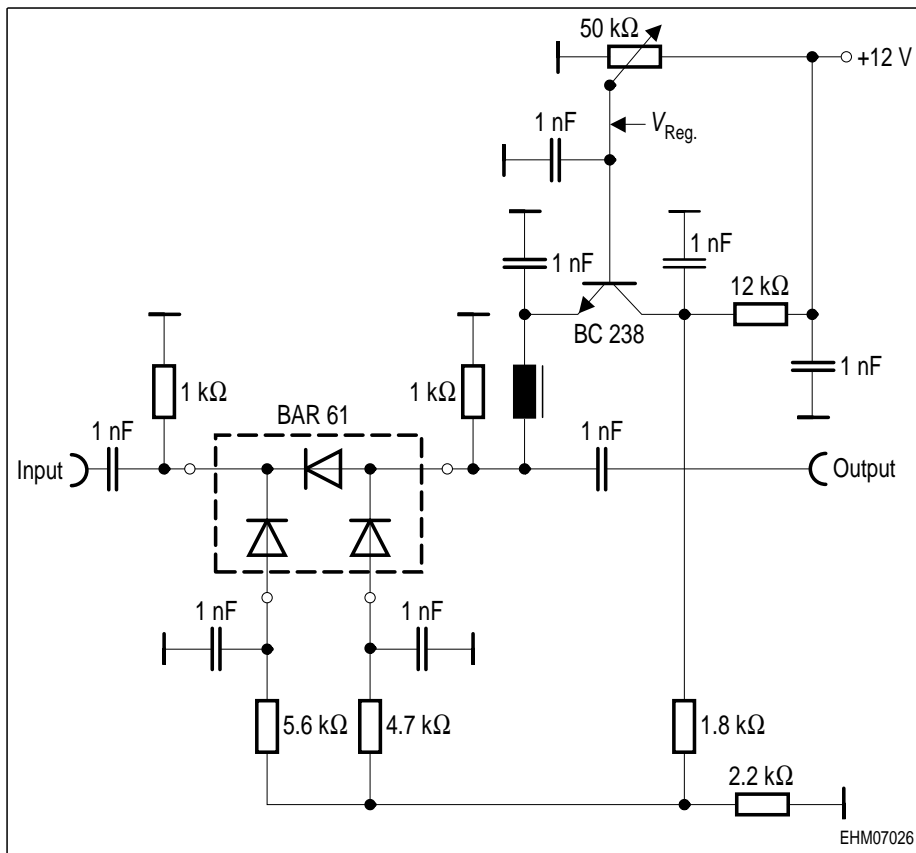

Package Outline

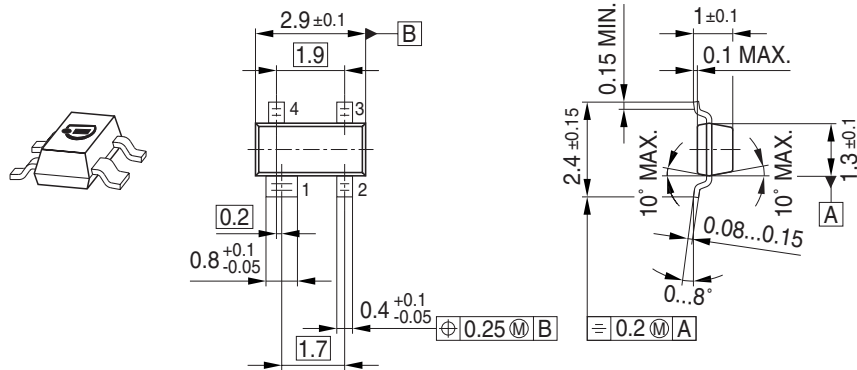

Foot Print

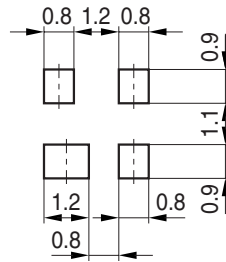

Marking Layout (Example)

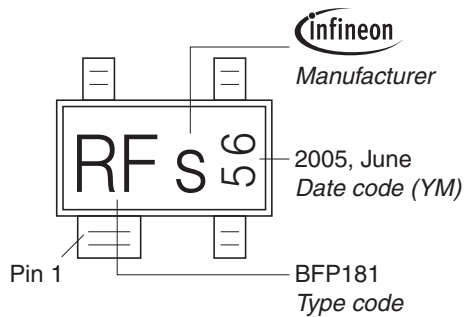

Standard Packing

Reel ø180 mm = 3.000 Pieces/Reel
 Reel ø330 mm = 10.000 Pieces/Reel

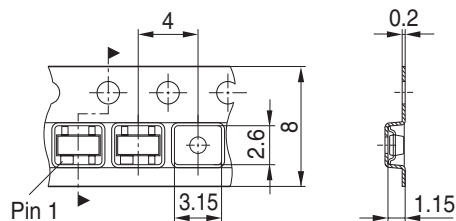

Package Outline



1) Lead width can be 0.6 max. in dambar area

Foot Print

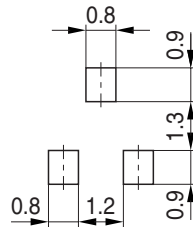

Marking Layout (Example)



Standard Packing

Reel \varnothing 180 mm = 3.000 Pieces/Reel
 Reel \varnothing 330 mm = 10.000 Pieces/Reel

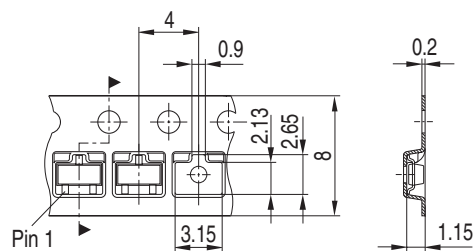

Edition 2009-11-16

**Published by
Infineon Technologies AG
81726 Munich, Germany**

**© 2009 Infineon Technologies AG
All Rights Reserved.**

Legal Disclaimer

The information given in this document shall in no event be regarded as a guarantee of conditions or characteristics. With respect to any examples or hints given herein, any typical values stated herein and/or any information regarding the application of the device, Infineon Technologies hereby disclaims any and all warranties and liabilities of any kind, including without limitation, warranties of non-infringement of intellectual property rights of any third party.

Information

For further information on technology, delivery terms and conditions and prices, please contact the nearest Infineon Technologies Office (www.infineon.com).

Warnings

Due to technical requirements, components may contain dangerous substances. For information on the types in question, please contact the nearest Infineon Technologies Office.

Infineon Technologies components may be used in life-support devices or systems only with the express written approval of Infineon Technologies, if a failure of such components can reasonably be expected to cause the failure of that life-support device or system or to affect the safety or effectiveness of that device or system. Life support devices or systems are intended to be implanted in the human body or to support and/or maintain and sustain and/or protect human life. If they fail, it is reasonable to assume that the health of the user or other persons may be endangered.