



# 16-Bit, High Speed, MicroPower Sampling ANALOG-TO-DIGITAL CONVERTER

## FEATURES

- BIPOLAR INPUT RANGE
- 100kHz SAMPLING RATE
- MICRO POWER:  
4.5mW at 100kHz  
1mW at 10kHz
- POWER DOWN: 3µA max
- MSOP-8 PACKAGE
- PIN-COMPATIBLE TO ADS7816 AND ADS7822
- SERIAL (SPI/SSI) INTERFACE

## APPLICATIONS

- BATTERY OPERATED SYSTEMS
- REMOTE DATA ACQUISITION
- ISOLATED DATA ACQUISITION
- SIMULTANEOUS SAMPLING,  
MULTI-CHANNEL SYSTEMS
- INDUSTRIAL CONTROLS
- ROBOTICS
- VIBRATION ANALYSIS

## DESCRIPTION

The ADS8321 is a 16-bit sampling analog-to-digital converter (ADC) with tested specifications over a 4.75V to 5.25V supply range. It requires very little power even when operating at the full 100kHz data rate. At lower data rates, the high speed of the device enables it to spend most of its time in the power-down mode—the average power dissipation is less than 1mW at 10kHz data rate.

The ADS8321 also features a synchronous serial (SPI/SSI compatible) interface, and a differential input. The reference voltage can be set to any level within the range of 500mV to  $V_{CC}/2$ .

Ultra-low power and small size make the ADS8321 ideal for portable and battery-operated systems. It is also a perfect fit for remote data acquisition modules, simultaneous multi-channel systems, and isolated data acquisition. The ADS8321 is available in an MSOP-8 package.

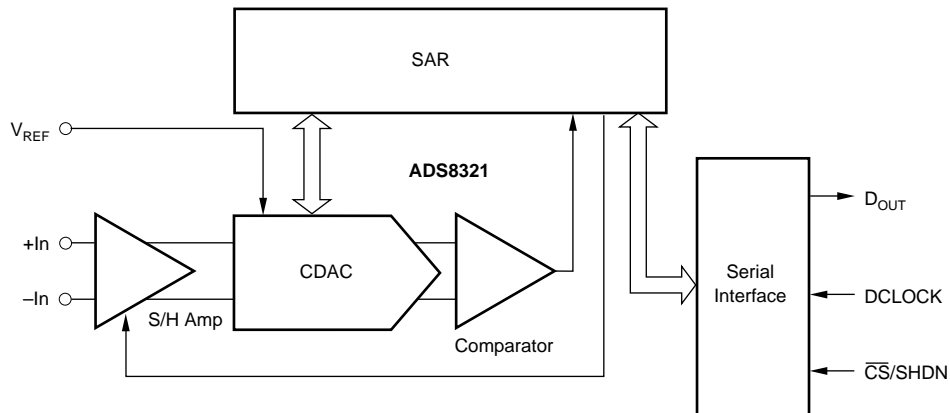

Please be aware that an important notice concerning availability, standard warranty, and use in critical applications of Texas Instruments semiconductor products and disclaimers thereto appears at the end of this data sheet.

All trademarks are the property of their respective owners.

## ABSOLUTE MAXIMUM RATINGS<sup>(1)</sup>

V <sub>CC</sub> .....	+6V
Analog Input .....	-0.3V to (V <sub>CC</sub> + 0.3V)
Logic Input .....	-0.3V to 6V
Case Temperature .....	+100°C
Junction Temperature .....	+150°C
Storage Temperature .....	+125°C
External Reference Voltage .....	+5.5V

NOTE: (1) Stresses above these ratings may permanently damage the device.



## ELECTROSTATIC DISCHARGE SENSITIVITY

This integrated circuit can be damaged by ESD. Texas Instruments recommends that all integrated circuits be handled with appropriate precautions. Failure to observe proper handling and installation procedures can cause damage.

ESD damage can range from subtle performance degradation to complete device failure. Precision integrated circuits may be more susceptible to damage because very small parametric changes could cause the device not to meet its published specifications.

## PACKAGE/ORDERING INFORMATION<sup>(1)</sup>

PRODUCT	MAXIMUM INTEGRAL LINEARITY ERROR (%)	NO MISSING CODE ERROR (LSB)	PACKAGE-LEAD	PACKAGE DESIGNATOR <sup>(1)</sup>	SPECIFICATION TEMPERATURE RANGE	PACKAGE MARKING	ORDERING NUMBER	TRANSPORT MEDIA, QUANTITY
ADS8321E	0.018	14	MSOP-8	DGK	-40°C to +85°C	A21	ADS8321E/250	Tape and Reel, 250
"	"	"	"	"	"	"	ADS8321E/2K5	Tape and Reel, 2500
ADS8321EB	0.012	15	MSOP-8	DGK	-40°C to +85°C	A21	ADS8321EB/250	Tape and Reel, 250
"	"	"	"	"	"	"	ADS8321EB/2K5	Tape and Reel, 2500

NOTE: (1) For the most current package and ordering information, see the Package Option Addendum located at the end of this data sheet.

## PIN CONFIGURATION

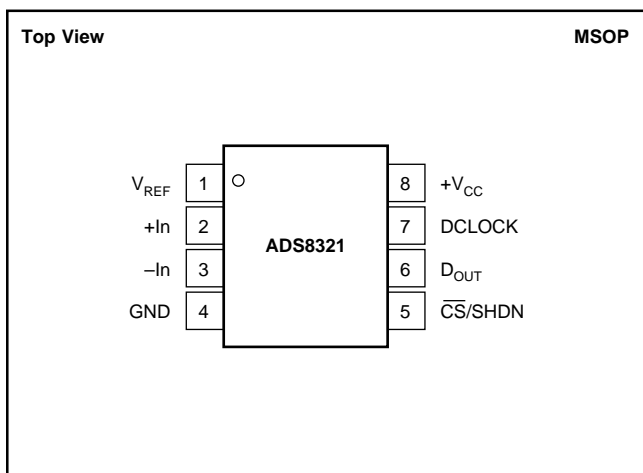

## PIN ASSIGNMENTS

PIN	NAME	DESCRIPTION
1	V <sub>REF</sub>	Reference Input
2	+In	Non Inverting Input
3	-In	Inverting Input
4	GND	Ground
5	$\overline{\text{CS}}/\text{SHDN}$	Chip Select when LOW, Shutdown Mode when HIGH.
6	D <sub>OUT</sub>	The serial output data word is comprised of 16 bits of data. In operation the data is valid on the falling edge of DCLOCK. The second clock pulse after the falling edge of $\overline{\text{CS}}$ enables the serial output. After one null bit, data is valid for the next 16 edges.
7	DCLOCK	Data Clock synchronizes the serial data transfer and determines conversion speed.
8	+V <sub>CC</sub>	Power Supply.

# SPECIFICATIONS: +V<sub>CC</sub> = +5V

At -40°C to +85°C, V<sub>REF</sub> = +2.5V, -I<sub>n</sub> = 2.5V, f<sub>SAMPLE</sub> = 100kHz, and f<sub>CLK</sub> = 24 • f<sub>SAMPLE</sub>, unless otherwise specified.

PARAMETER	CONDITIONS	ADS8321E			ADS8321EB			UNITS
		MIN	TYP	MAX	MIN	TYP	MAX	
<b>RESOLUTION</b>				16			*	Bits
<b>ANALOG INPUT</b>								
Full-Scale Input Span	+I <sub>n</sub> - (-I <sub>n</sub> )	-V <sub>REF</sub>		+V <sub>REF</sub>	*		*	V
Absolute Input Range	+I <sub>n</sub>	-0.1		V <sub>CC</sub> + 0.1	*		*	V
	-I <sub>n</sub>	-0.1		+4.0	*		*	V
Capacitance			25			*		pF
Leakage Current			1			*		nA
<b>SYSTEM PERFORMANCE</b>								
No Missing Codes		14			15			Bits
Integral Linearity Error			±0.008	±0.018		±0.006	±0.012	% of FSR
Offset Error			±0.4	±2		±0.2	±1	mV
Offset Temperature Drift			±1			*		μV/°C
Gain Error, Positive				±0.05			±0.024	%
Gain Error, Negative				±0.05			±0.024	%
Gain Temperature Drift			±0.3			*		ppm/°C
Noise			60			*		μVrms
Common-Mode Rejection Ratio			80			*		dB
Power Supply Rejection Ratio	+4.7V < V <sub>CC</sub> < 5.25V		3			*		LSB <sup>(1)</sup>
<b>SAMPLING DYNAMICS</b>								
Conversion Time				16			*	Clk Cycles
Acquisition Time		4.5			*			Clk Cycles
Throughput Rate				100			*	kHz
Clock Frequency Range		0.024		2.9	*		*	MHz
<b>DYNAMIC CHARACTERISTICS</b>								
Total Harmonic Distortion	V <sub>IN</sub> = 5Vp-p at 10kHz		-84			-86		dB
SINAD	V <sub>IN</sub> = 5Vp-p at 10kHz		82			84		dB
Spurious Free Dynamic Range	V <sub>IN</sub> = 5Vp-p at 10kHz		84			86		dB
SNR			85			87		dB
<b>REFERENCE INPUT</b>								
Voltage Range		0.5		V <sub>CC</sub> /2	*		*	V
Resistance	$\overline{CS} = GND, f_{SAMPLE} = 0Hz$		5			*		GΩ
	$\overline{CS} = V_{CC}$		5			*		GΩ
Current Drain			40	80		*	*	μA
	f <sub>SAMPLE</sub> = 10kHz		0.8			*		μA
	$\overline{CS} = V_{CC}$		0.1	3		*		μA
<b>DIGITAL INPUT/OUTPUT</b>								
Logic Family			CMOS			*		
Logic Levels:								
V <sub>IH</sub>	I <sub>IH</sub> = +5μA	3.0		V <sub>CC</sub> + 0.3	*		*	V
V <sub>IL</sub>	I <sub>IL</sub> = +5μA	-0.3		0.8	*		*	V
V <sub>OH</sub>	I <sub>OH</sub> = -250μA	4.0			*		*	V
V <sub>OL</sub>	I <sub>OL</sub> = 250μA			0.4			*	V
Data Format				Binary Two's Complement		*		
<b>POWER SUPPLY REQUIREMENTS</b>								
V <sub>CC</sub>	Specified Performance	4.75		5.25	*		*	V
V <sub>CC</sub> Range <sup>(2)</sup>		2.7		5.25	*		*	V
Quiescent Current			1100	1700		*	*	μA
	f <sub>SAMPLE</sub> = 10kHz <sup>(3, 4)</sup>		250			*	*	μA
Power Dissipation			5.5	8.5		*	*	mW
Power Down	$\overline{CS} = V_{CC}$		0.3	3		*	*	μA
<b>TEMPERATURE RANGE</b>								
Specified Performance		-40		+85	*		*	°C

\* Specifications same as ADS8321E.

NOTES: (1) LSB means Least Significant Bit. (2) See Typical Performance Curves for more information. (3) f<sub>CLK</sub> = 2.4MHz,  $\overline{CS} = V_{CC}$  for 216 clock cycles out of every 240. (4) See the Power Dissipation section for more information regarding lower sample rates.

# TYPICAL PERFORMANCE CURVES

At  $T_A = +25^\circ\text{C}$ ,  $V_{CC} = +5\text{V}$ ,  $V_{REF} = +2.5\text{V}$ ,  $f_{\text{SAMPLE}} = 100\text{kHz}$ ,  $f_{\text{CLK}} = 24 \cdot f_{\text{SAMPLE}}$ , unless otherwise specified.

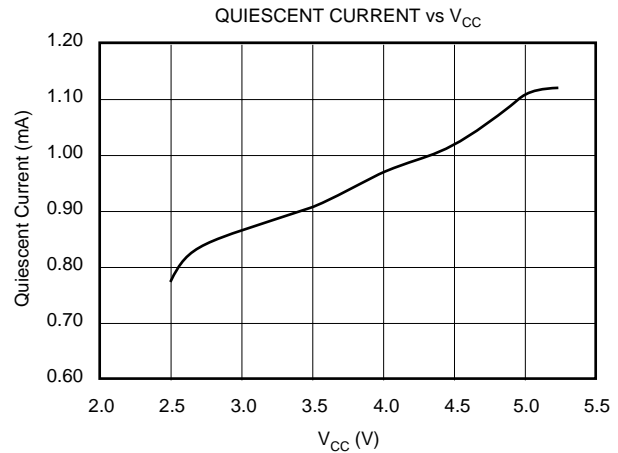
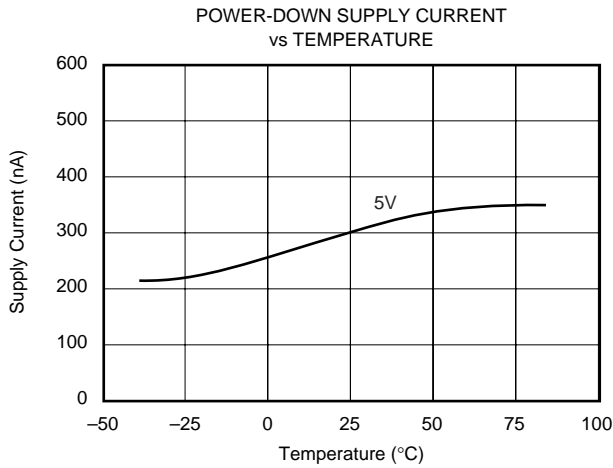
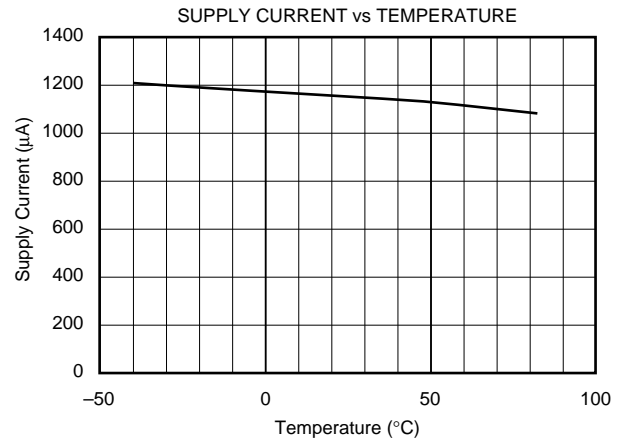
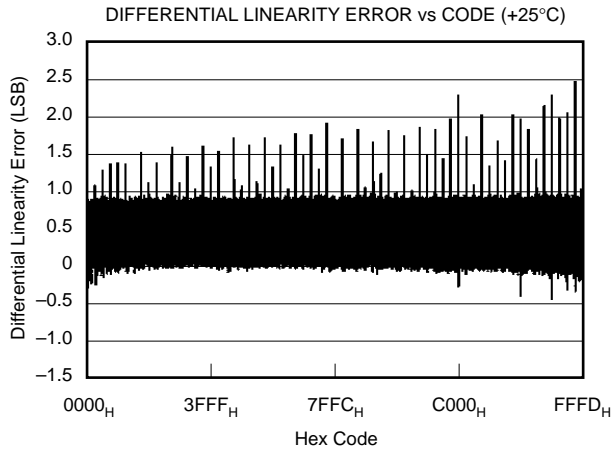
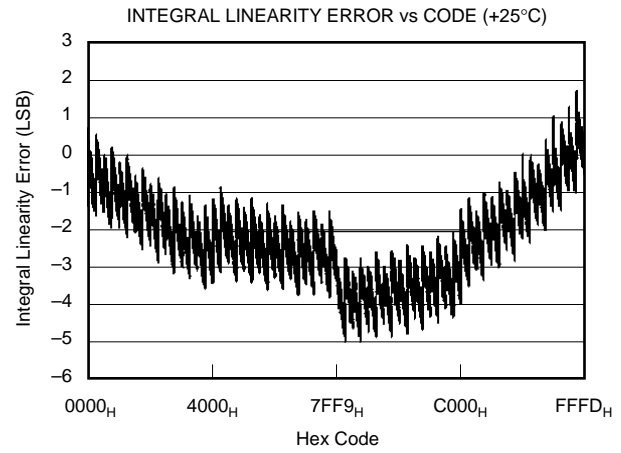
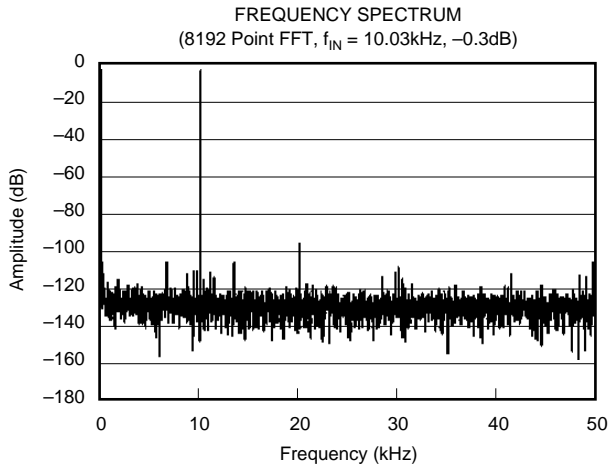

# TYPICAL PERFORMANCE CURVES (Cont.)

At  $T_A = +25^\circ\text{C}$ ,  $V_{CC} = +5\text{V}$ ,  $V_{REF} = +2.5\text{V}$ ,  $f_{SAMPLE} = 100\text{kHz}$ ,  $f_{CLK} = 24 \cdot f_{SAMPLE}$ , unless otherwise specified.

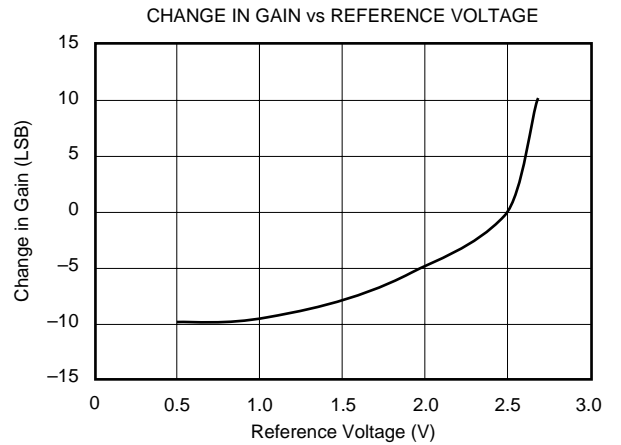
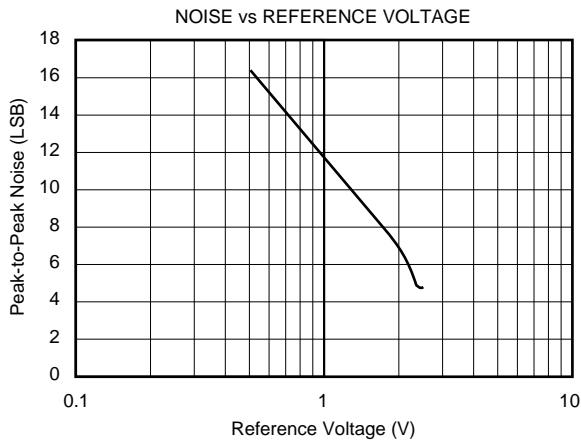
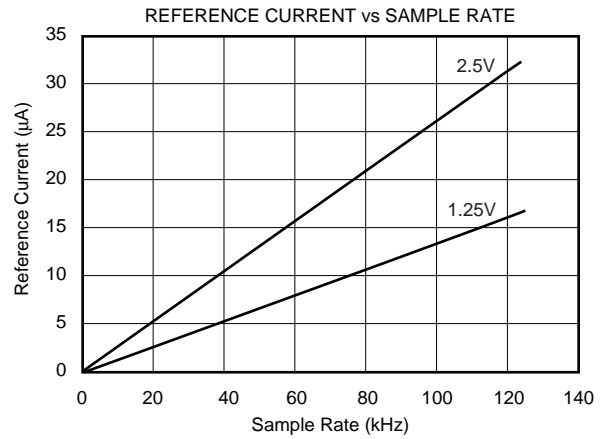
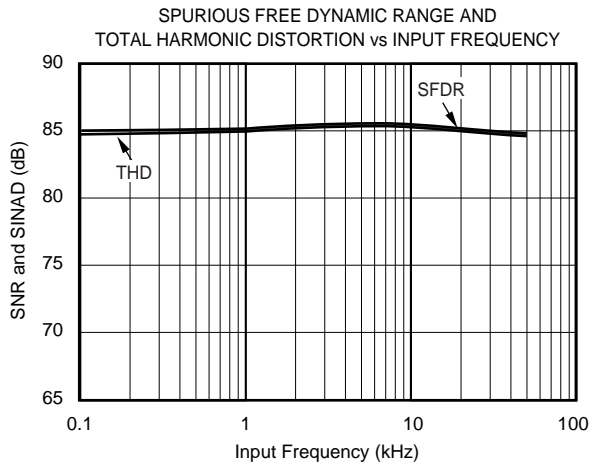
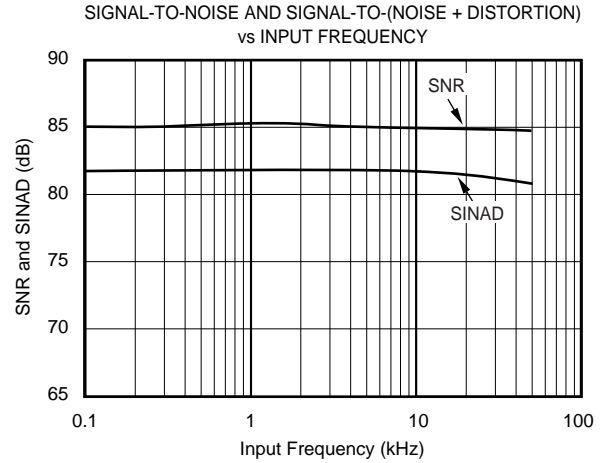
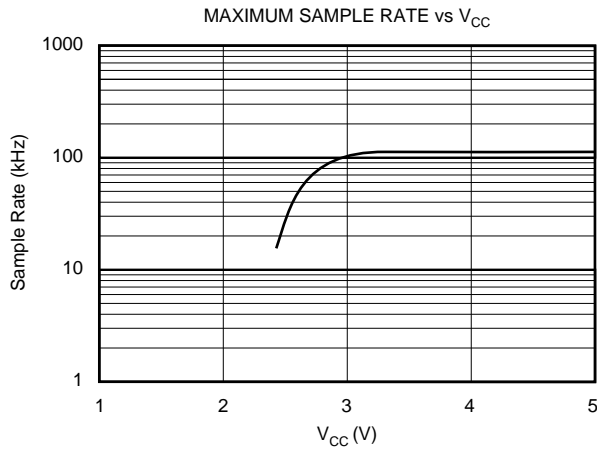

# TYPICAL PERFORMANCE CURVES (Cont.)

At  $T_A = +25^\circ\text{C}$ ,  $V_{CC} = +5\text{V}$ ,  $V_{REF} = +2.5\text{V}$ ,  $f_{SAMPLE} = 100\text{kHz}$ ,  $f_{CLK} = 24 \cdot f_{SAMPLE}$ , unless otherwise specified.

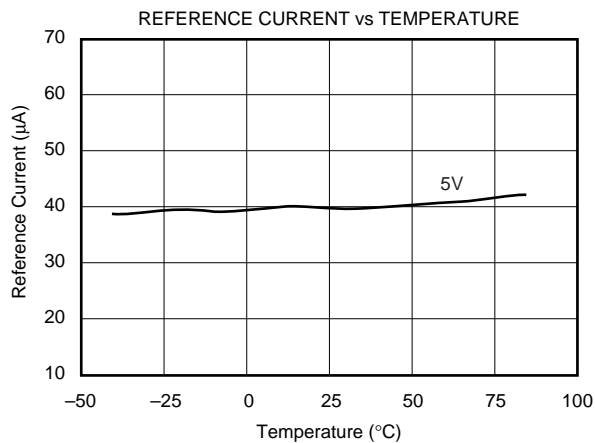
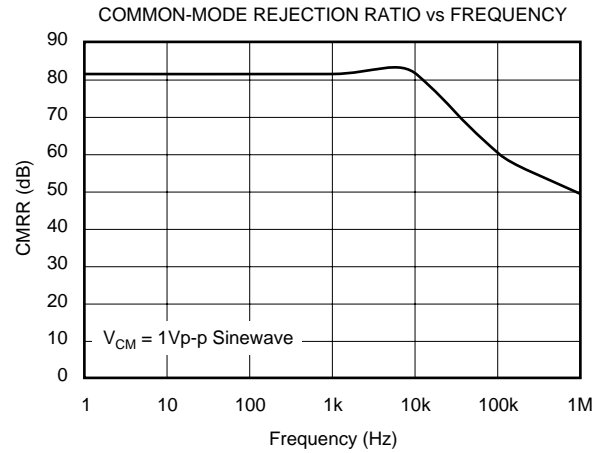
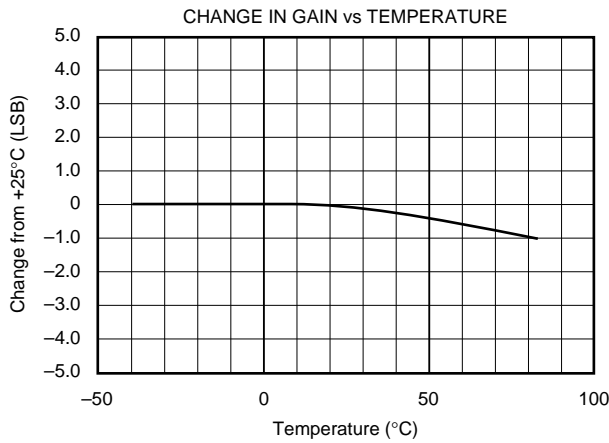
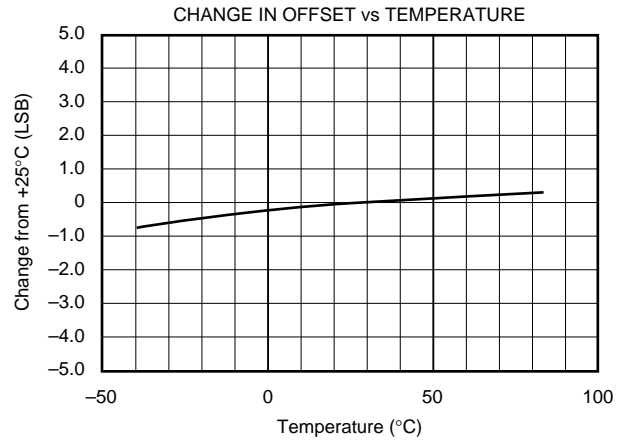
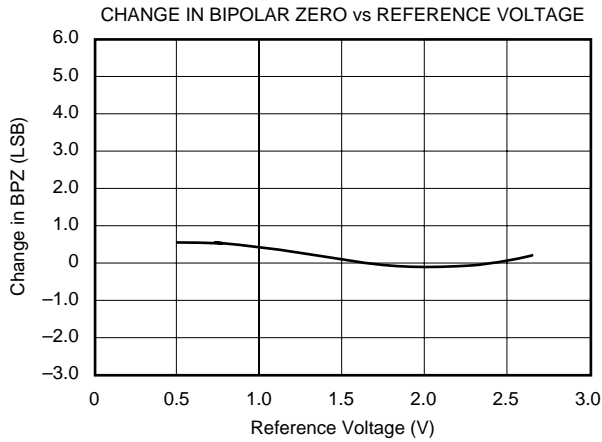

# THEORY OF OPERATION

The ADS8321 is a classic Successive Approximation Register (SAR) analog-to-digital converter (ADC). The architecture is based on capacitive redistribution which inherently includes a sample/hold function. The converter is fabricated on a 0.6 $\mu$  CMOS process. The architecture and process allow the ADS8321 to acquire and convert an analog signal at up to 100,000 conversions per second while consuming less than 5.5mW from +V<sub>CC</sub>.

The ADS8321 requires an external reference, an external clock, and a single power source (V<sub>CC</sub>). The external reference can be any voltage between 500mV and V<sub>CC</sub>/2. The value of the reference voltage directly sets the range of the analog input. The reference input current depends on the conversion rate of the ADS8321.

The external clock can vary between 24kHz (1kHz throughput) and 2.4MHz (100kHz throughput). The duty cycle of the clock is essentially unimportant as long as the minimum high and low times are at least 200ns (4.75V or greater). The minimum clock frequency is set by the leakage on the capacitors internal to the ADS8321.

The analog input is provided to two input pins: +In and -In. When a conversion is initiated, the differential input on these pins is sampled on the internal capacitor array. While a conversion is in progress, both inputs are disconnected from any internal function.

The digital result of the conversion is clocked out by the DCLOCK input and is provided serially, most significant bit first, on the D<sub>OUT</sub> pin. The digital data that is provided on the D<sub>OUT</sub> pin is for the conversion currently in progress—there is no pipeline delay. It is possible to continue to clock the ADS8321 after the conversion is complete and to obtain the serial data least significant bit first. See the digital timing section for more information.

## ANALOG INPUT

The analog input is bipolar and fully differential. There are two general methods of driving the analog input of the ADS8321: single-ended or differential (see Figure 1). When the input is single-ended, the -In input is held at a fixed voltage. The +In input swings around the same voltage and the peak-to-peak amplitude is 2 • V<sub>REF</sub>. The value of V<sub>REF</sub> determines the range over which the common voltage may vary (see Figure 2).

When the input is differential, the amplitude of the input is the difference between the +In and -In input, or; +In - (-In). A voltage or signal is common to both of these inputs. The peak-to-peak amplitude of each input is V<sub>REF</sub> about this common voltage. However, since the inputs are 180°C out-of-phase, the peak-to-peak amplitude of the difference voltage is 2 • V<sub>REF</sub>. The value of V<sub>REF</sub> also determines the range of the voltage that may be common to both inputs (see Figure 3).

In each case, care should be taken to ensure that the output impedance of the sources driving the +In and -In inputs are matched. If this is not observed, the two inputs could have

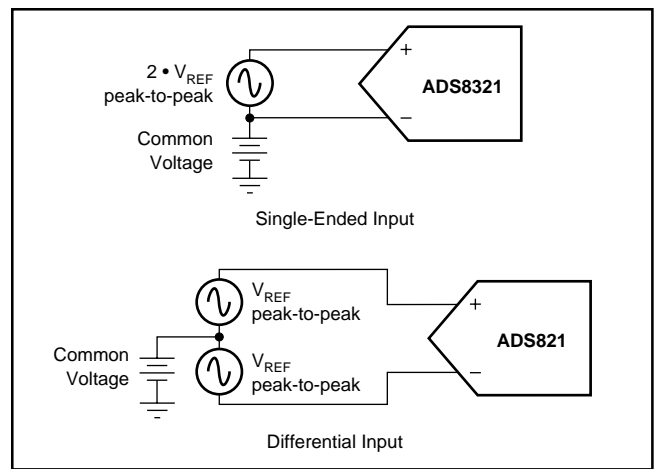

FIGURE 1. Methods of Driving the ADS8321—Single-Ended or Differential.

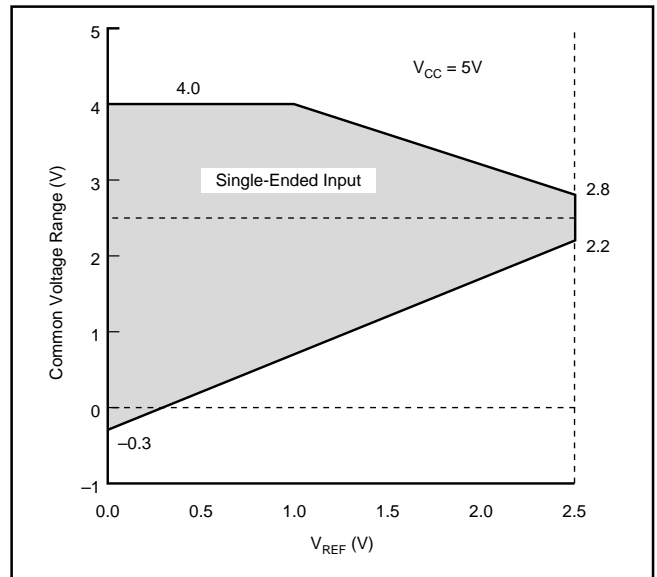

FIGURE 2. Single-Ended Input—Common Voltage Range vs V<sub>REF</sub>.

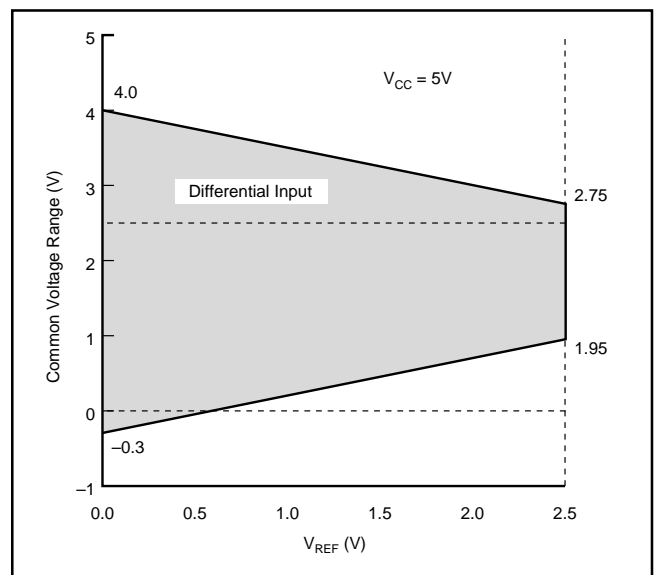

FIGURE 3. Differential Input—Common Voltage Range vs V<sub>REF</sub>.

different settling times. This may result in offset error, gain error, and linearity error which change with both temperature and input voltage. If the impedance cannot be matched, the errors can be lessened by giving the ADS8321 additional acquisition time.

The input current on the analog inputs depends on a number of factors: sample rate, input voltage, and source impedance. Essentially, the current into the ADS8321 charges the internal capacitor array during the sample period. After this capacitance has been fully charged, there is no further input current. The source of the analog input voltage must be able to charge the input capacitance (25pF) to 16-bit settling level within 4.5 clock cycles. When the converter goes into the hold mode or while it is in the power-down mode, the input impedance is greater than 1GΩ.

Care must be taken regarding the absolute analog input voltage. The +In input should always remain within the range of GND – 300mV to V<sub>CC</sub> + 300mV. The –In input should always remain within the range of GND – 300mV to 4V. Outside of these ranges, the converter’s linearity may not meet specifications.

## REFERENCE INPUT

The external reference sets the analog input range. The ADS8321 will operate with a reference in the range of 500mV to 2.5V. There are several important implications of this. As the reference voltage is reduced, the analog voltage weight of each digital output code is reduced. This is often referred to as the Least Significant Bit (LSB) size and is equal to  $2 \cdot V_{REF}$  divided by 65,535. This means that any offset or gain error inherent in the ADC will appear to increase, in terms of LSB size, as the reference voltage is reduced.

The noise inherent in the converter will also appear to increase with lower LSB size. With a +2.5V reference, the internal noise of the converter typically contributes only 5 LSB peak-to-peak of potential error to the output code. When the external reference is 500mV, the potential error contribution from the internal noise will be 10 times larger—15 LSBs. The errors due to the internal noise are gaussian in nature and can be reduced by averaging consecutive conversion results.

For more information regarding noise, consult the typical performance curve “Noise vs Reference Voltage.” Note that the Effective Number of Bits (ENOB) figure is calculated based on the converter’s signal-to-(noise + distortion) ratio with a 1kHz, 0dB input signal. SINAD is related to ENOB as follows:

$$\text{SINAD} = 6.02 \cdot \text{ENOB} + 1.76$$

With lower reference voltages, extra care should be taken to provide a clean layout including adequate bypassing, a clean power supply, a low-noise reference, and a low-noise input signal. Because the LSB size is lower, the converter will also be more sensitive to external sources of error such as nearby digital signals and electromagnetic interference.

## NOISE

The noise floor of the ADS8321 itself is extremely low, as can be seen from Figures 4 and 5, and is much lower than competing A/D converters. It was tested by applying a low noise DC input and a 2.5V reference to the ADS8321 and initiating 5,000 conversions. The digital output of the ADC will vary in output code due to the internal noise of the ADS8321. This is true for all 16-bit SAR-type ADCs. Using a histogram to plot the output codes, the distribution should appear bell-shaped with the peak of the bell curve representing the nominal code for the input value. The  $\pm 1\sigma$ ,  $\pm 2\sigma$ , and  $\pm 3\sigma$  distributions will represent the 68.3%, 95.5%, and 99.7%, respectively, of all codes. The transition noise can be calculated by dividing the number of codes measured by 6 and this will yield the  $\pm 3\sigma$  distribution or 99.7% of all codes. Statistically, up to 3 codes could fall outside the distribution when executing 1000 conversions. The ADS8321, with five output codes for the  $\pm 3\sigma$  distribution, will yield a  $\pm 0.8\text{LSB}$  transition noise. Remember, to achieve this low noise performance, the peak-to-peak noise of the input signal and reference must be  $< 50\mu\text{V}$ .

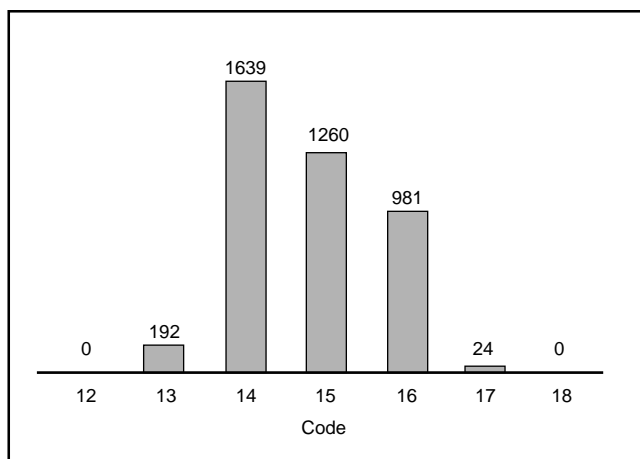

FIGURE 4. Histogram of 5,000 Conversions of a DC Input at the Code Transition.

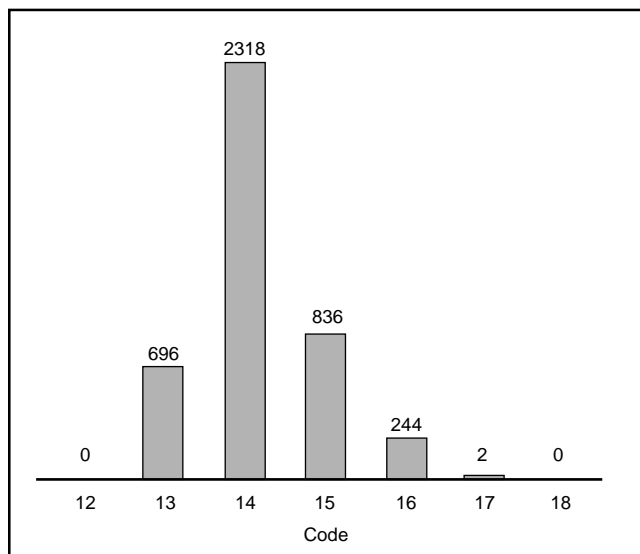

FIGURE 5. Histogram of 5,000 Conversions of a DC Input at the Code Center.



## AVERAGING

The noise of the ADC can be compensated by averaging the digital codes. By averaging conversion results, transition noise will be reduced by a factor of  $1/\sqrt{n}$ , where  $n$  is the number of averages. For example, averaging 4 conversion results will reduce the transition noise by 1/2 to  $\pm 0.25$  LSBs. Averaging should only be used for input signals with frequencies near DC.

For AC signals, a digital filter can be used to low pass filter and decimate the output codes. This works in a similar manner to averaging; for every decimation by 2, the signal-to-noise ratio will improve 3dB.

## DIGITAL INTERFACE

### SIGNAL LEVELS

The digital inputs of the ADS8321 can accommodate logic levels up to 5.5V regardless of the value of  $V_{CC}$ .

The CMOS digital output ( $D_{OUT}$ ) will swing 0V to  $V_{CC}$ . If  $V_{CC}$  is 3V and this output is connected to a 5V CMOS logic input, then that IC may require more supply current than normal and may have a slightly longer propagation delay.

### SERIAL INTERFACE

The ADS8321 communicates with microprocessors and other digital systems via a synchronous 3-wire serial interface as shown in Figure 6 and Table I. The DCLOCK signal synchronizes the data transfer with each bit being transmitted on the falling edge of DCLOCK. Most receiving systems will capture the bitstream on the rising edge of DCLOCK. However, if the minimum hold time for  $D_{OUT}$  is acceptable, the system can use the falling edge of DCLOCK to capture each bit.

SYMBOL	DESCRIPTION	MIN	TYP	MAX	UNITS
$t_{SMPL}$	Analog Input Sample Time	4.5		5.0	Clk Cycles
$t_{CONV}$	Conversion Time		16		Clk Cycles
$t_{CYC}$	Throughput Rate			100	kHz
$t_{CSD}$	$\overline{CS}$ Falling to DCLOCK LOW			0	ns
$t_{SUCS}$	$\overline{CS}$ Falling to DCLOCK Rising	20			ns
$t_{hDO}$	DCLOCK Falling to Current $D_{OUT}$ Not Valid	5	15		ns
$t_{dDO}$	DCLOCK Falling to Next $D_{OUT}$ Valid		30	50	ns
$t_{dis}$	$\overline{CS}$ Rising to $D_{OUT}$ Tri-State		70	100	ns
$t_{en}$	DCLOCK Falling to $D_{OUT}$ Enabled		20	50	ns
$t_f$	$D_{OUT}$ Fall Time		5	25	ns
$t_r$	$D_{OUT}$ Rise Time		7	25	ns

TABLE I. Timing Specifications ( $V_{CC} = 5V$ )  $-40^{\circ}C$  to  $+85^{\circ}C$ .

A falling  $\overline{CS}$  signal initiates the conversion and data transfer. The first 4.5 to 5.0 clock periods of the conversion cycle are used to sample the input signal. After the fifth falling DCLOCK edge,  $D_{OUT}$  is enabled and will output a LOW value for one clock period. For the next 16 DCLOCK periods,  $D_{OUT}$  will output the conversion result, most significant bit first. After the least significant bit (B0) has been output, subsequent clocks will repeat the output data but in a least significant bit first format.

After the most significant bit (B15) has been repeated,  $D_{OUT}$  will tri-state. Subsequent clocks will have no effect on the converter. A new conversion is initiated only when  $\overline{CS}$  has been taken HIGH and returned LOW.

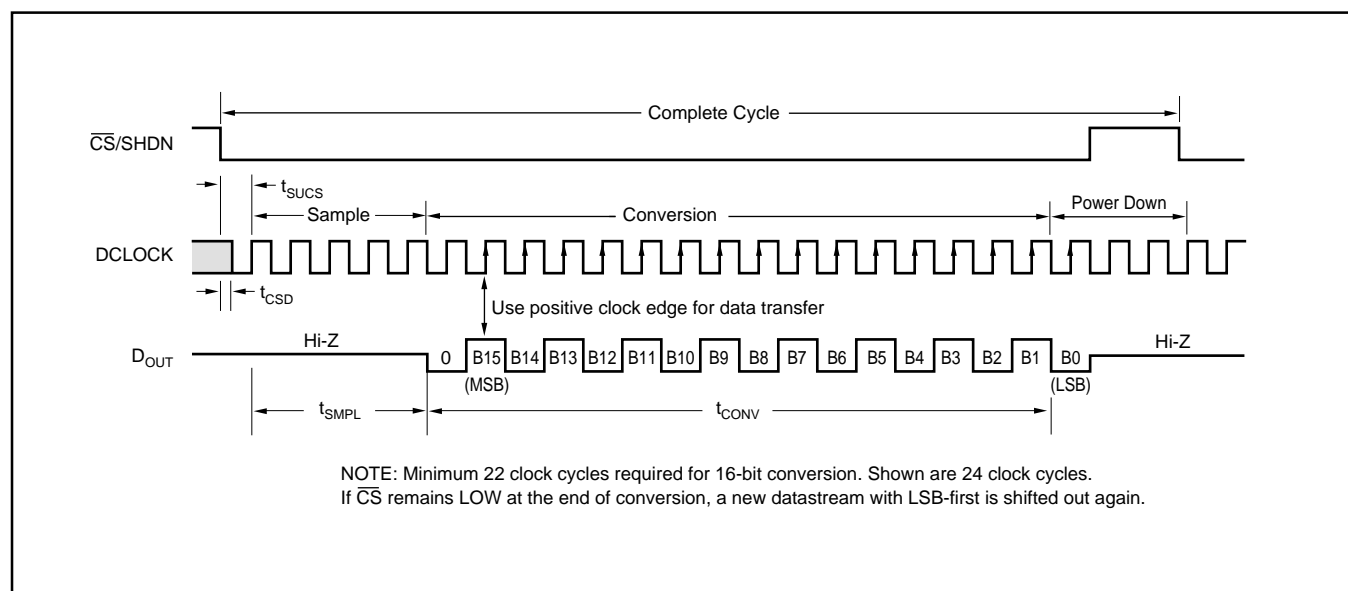

FIGURE 6. ADS8321 Basic Timing Diagrams.

## DATA FORMAT

The output data from the ADS8321 is in Binary Two's Complement format as shown in Table II. This table represents the ideal output code for the given input voltage and does not include the effects of offset, gain error, or noise.

DESCRIPTION	ANALOG VALUE	DIGITAL OUTPUT BINARY TWO'S COMPLEMENT	
		BINARY CODE	HEX CODE
Full-Scale Range	$2 \cdot V_{REF}$		
Least Significant Bit (LSB)	$2 \cdot V_{REF}/65536$		
+Full Scale	$+V_{REF} - 1 \text{ LSB}$	0111 1111 1111 1111	7FFF
Midscale	0V	0000 0000 0000 0000	0000
Midscale - 1LSB	$0V - 1 \text{ LSB}$	1111 1111 1111 1111	FFFF
-Full Scale	$-V_{REF}$	1000 0000 0000 0000	8000

TABLE II. Ideal Input Voltages and Output Codes.

## POWER DISSIPATION

The architecture of the converter, the semiconductor fabrication process, and a careful design allow the ADS8321 to convert at up to a 100kHz rate while requiring very little power. Still, for the absolute lowest power dissipation, there are several things to keep in mind.

The power dissipation of the ADS8321 scales directly with conversion rate. Therefore, the first step to achieving the lowest power dissipation is to find the lowest conversion rate that will satisfy the requirements of the system.

In addition, the ADS8321 is in power-down mode under two conditions: when the conversion is complete and whenever  $\overline{\text{CS}}$  is HIGH (see Figure 6). Ideally, each conversion should occur as quickly as possible, preferably at a 2.4MHz clock rate. This way, the converter spends the longest possible time in the power-down mode. This is very important as the converter not only uses power on each DCLOCK transition (as is typical for digital CMOS components) but also uses some current for the analog circuitry, such as the comparator. The analog section dissipates power continuously, until the power down mode is entered.

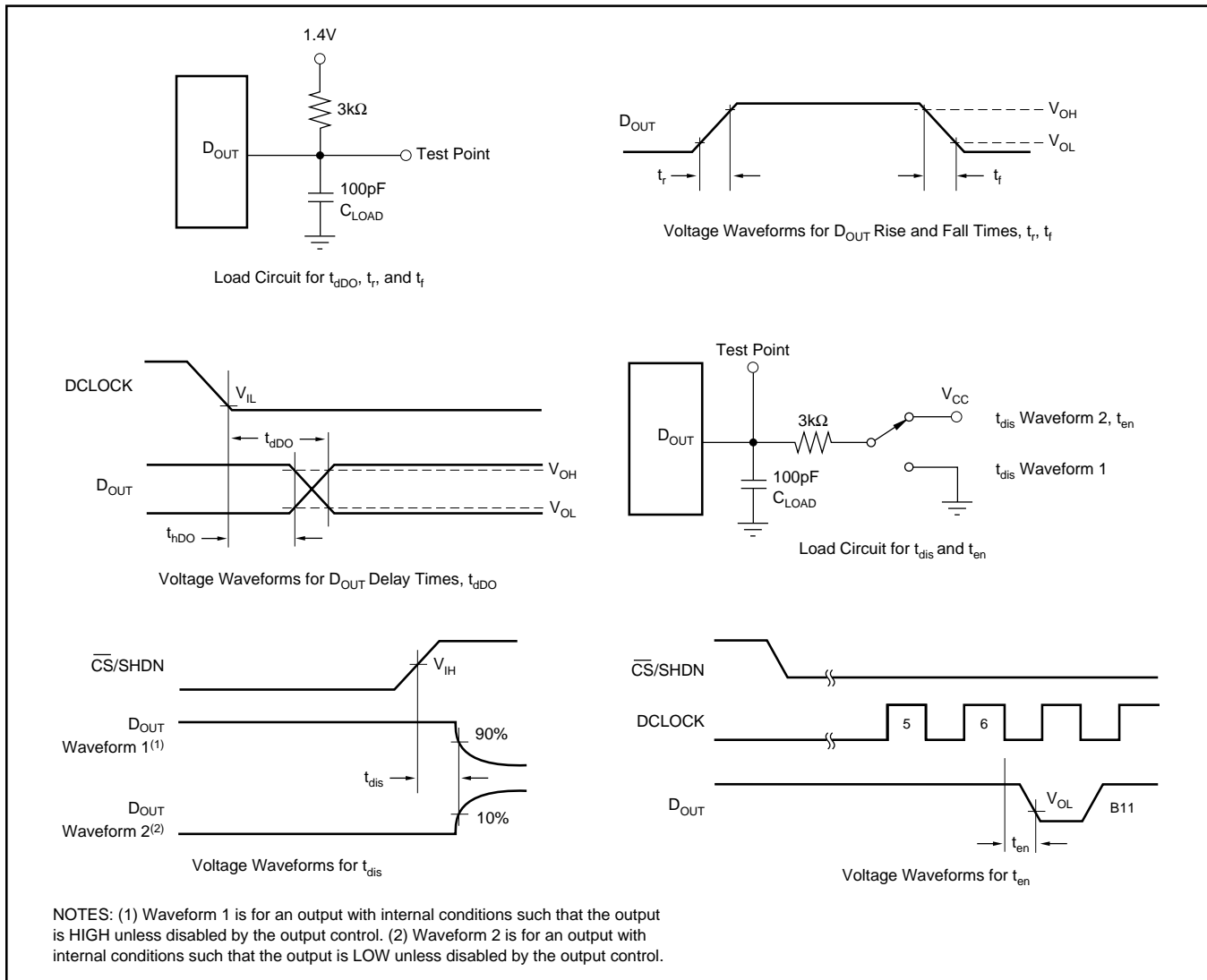

FIGURE 7. Timing Diagrams and Test Circuits for the Parameters in Table I.

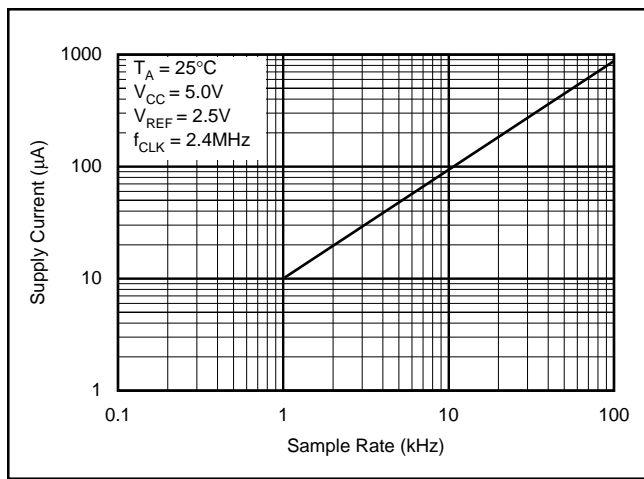

FIGURE 8. Maintaining  $f_{CLK}$  at the Highest Possible Rate Allows Supply Current to Drop Linearly with Sample Rate.

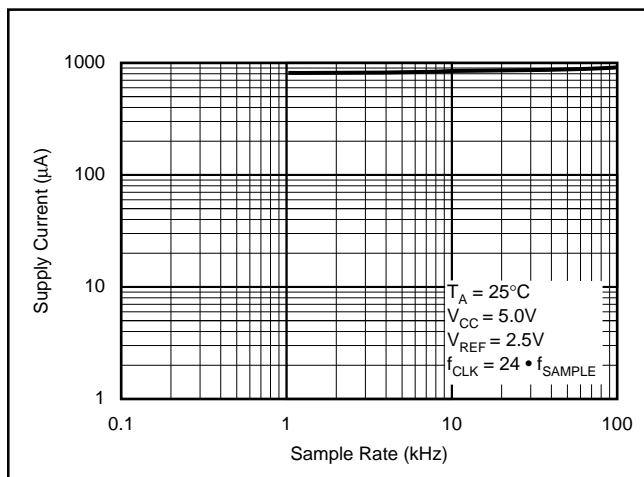

FIGURE 9. Scaling  $f_{CLK}$  Reduces Supply Current Only Slightly with Sample Rate.

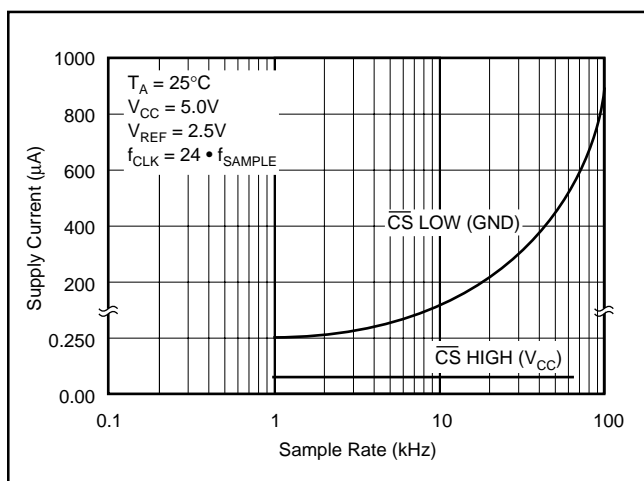

FIGURE 10. Shutdown Current with  $\overline{CS}$  HIGH is 50nA Typically, Regardless of the Clock. Shutdown Current with  $\overline{CS}$  LOW Varies with Sample Rate.

Figure 8 shows the current consumption of the ADS8321 versus sample rate. For this graph, the converter is clocked at 2.4MHz regardless of the sample rate— $\overline{CS}$  is HIGH for the remaining sample period. Figure 9 also shows current consumption versus sample rate. However, in this case, the DCLOCK period is 1/24th of the sample period— $\overline{CS}$  is HIGH for one DCLOCK cycle out of every 16.

There is an important distinction between the power-down mode that is entered after a conversion is complete and the full power-down mode which is enabled when  $\overline{CS}$  is HIGH.  $\overline{CS}$  LOW will shut down only the analog section. The digital section is completely shutdown only when  $\overline{CS}$  is HIGH. Thus, if  $\overline{CS}$  is left LOW at the end of a conversion and the converter is continually clocked, the power consumption will not be as low as when  $\overline{CS}$  is HIGH. See Figure 10 for more information.

## SHORT CYCLING

Another way of saving power is to utilize the  $\overline{CS}$  signal to short cycle the conversion. Because the ADS8321 places the latest data bit on the  $D_{OUT}$  line as it is generated, the converter can easily be short cycled. This term means that the conversion can be terminated at any time. For example, if only 14 bits of the conversion result are needed, then the conversion can be terminated (by pulling  $\overline{CS}$  HIGH) after the 14th bit has been clocked out.

This technique can be used to lower the power dissipation (or to increase the conversion rate) in those applications where an analog signal is being monitored until some condition becomes true. For example, if the signal is outside a predetermined range, the full 16-bit conversion result may not be needed. If so, the conversion can be terminated after the first  $n$  bits, where  $n$  might be as low as 3 or 4. This results in lower power dissipation in both the converter and the rest of the system, as they spend more time in the power-down mode.

## LAYOUT

For optimum performance, care should be taken with the physical layout of the ADS8321 circuitry. This will be particularly true if the reference voltage is low and/or the conversion rate is high. At a 100kHz conversion rate, the ADS8321 makes a bit decision every 416ns. That is, for each subsequent bit decision, the digital output must be updated with the results of the last bit decision, the capacitor array appropriately switched and charged, and the input to the comparator settled to a 16-bit level all within one clock cycle.

The basic SAR architecture is sensitive to spikes on the power supply, reference, and ground connections that occur just prior to latching the comparator output. Thus, during any single conversion for an  $n$ -bit SAR converter, there are  $n$  “windows” in which large external transient voltages can easily affect the conversion result. Such spikes might originate from switching power supplies, digital logic, and high

power devices, to name a few. This particular source of error can be very difficult to track down if the glitch is almost synchronous to the converter's DCLOCK signal—as the phase difference between the two changes with time and temperature, causing sporadic misoperation.

With this in mind, power to the ADS8321 should be clean and well bypassed. A 0.1μF ceramic bypass capacitor should be placed as close to the ADS8321 package as possible. In addition, a 1μF to 10μF capacitor and a 5Ω or 10Ω series resistor may be used to lowpass filter a noisy supply.

The reference should be similarly bypassed with a 0.1μF capacitor. Again, a series resistor and large capacitor can be used to lowpass filter the reference voltage. If the reference voltage originates from an op amp, be careful that the op amp can drive the bypass capacitor without oscillation (the series resistor can help in this case). Keep in mind that while the ADS8321 draws very little current from the reference on average, there are still instantaneous current demands placed on the external input and reference circuitry.

Texas Instruments OPA627 op amp provides optimum performance for buffering both the signal and reference inputs. For low cost, low voltage, single-supply applications, the OPA2350 or OPA2340 dual op amps are recommended.

Also, keep in mind that the ADS8321 offers no inherent rejection of noise or voltage variation in regards to the

reference input. This is of particular concern when the reference input is tied to the power supply. Any noise and ripple from the supply will appear directly in the digital results. While high frequency noise can be filtered out as described in the previous paragraph, voltage variation due to the line frequency (50Hz or 60Hz), can be difficult to remove.

The GND pin on the ADS8321 should be placed on a clean ground point. In many cases, this will be the “analog” ground. Avoid connecting the GND pin too close to the grounding point for a microprocessor, microcontroller, or digital signal processor. If needed, run a ground trace directly from the converter to the power supply connection point. The ideal layout will include an analog ground plane for the converter and associated analog circuitry.

## APPLICATION CIRCUITS

Figure 11 shows a basic data acquisition system. The ADS8321 input range is 0V to V<sub>CC</sub>, as the reference input is connected directly to the power supply. The 5Ω resistor and 1μF to 10μF capacitor filter the microcontroller “noise” on the supply, as well as any high-frequency noise from the supply itself. The exact values should be picked such that the filter provides adequate rejection of the noise.

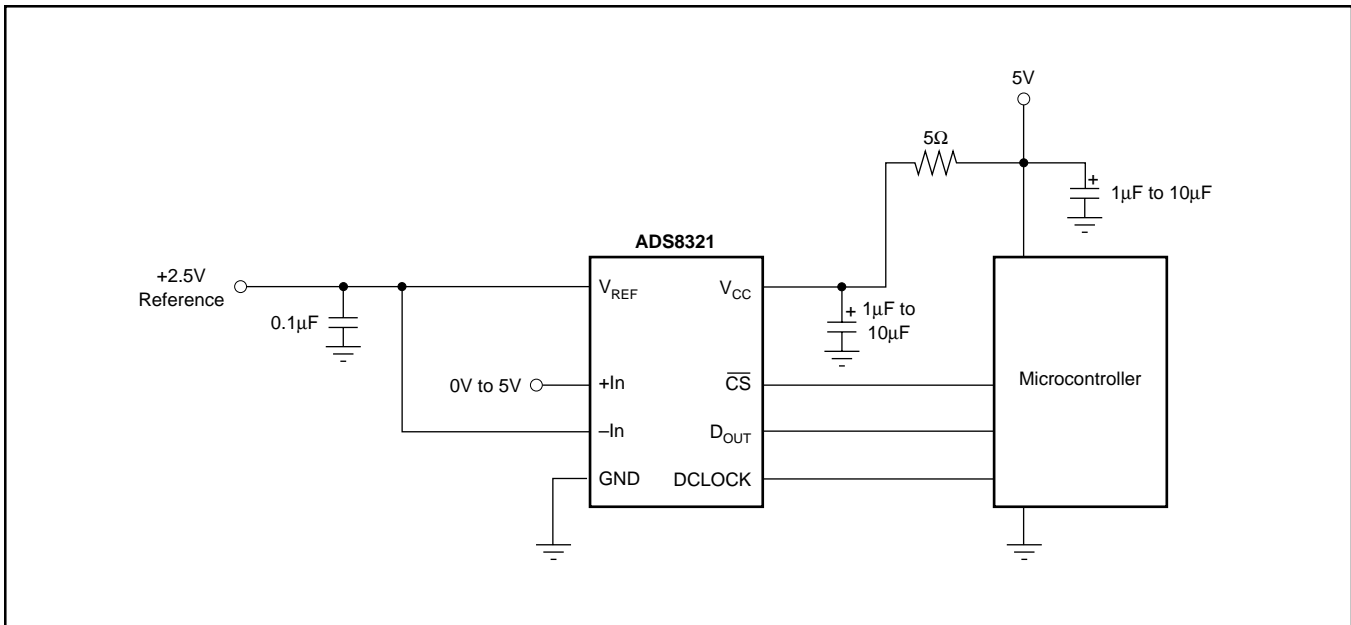

FIGURE 11. Basic Data Acquisition System.

**PACKAGING INFORMATION**

Orderable Device	Status <sup>(1)</sup>	Package Type	Package Drawing	Pins	Package Qty	Eco Plan <sup>(2)</sup>	Lead/ Ball Finish	MSL Peak Temp <sup>(3)</sup>	Samples (Requires Login)
ADS8321E/250	ACTIVE	VSSOP	DGK	8	250	Green (RoHS & no Sb/Br)	CU NIPDAUAG	Level-2-260C-1 YEAR	
ADS8321E/250G4	ACTIVE	VSSOP	DGK	8	250	Green (RoHS & no Sb/Br)	CU NIPDAUAG	Level-2-260C-1 YEAR	
ADS8321E/2K5	ACTIVE	VSSOP	DGK	8	2500	Green (RoHS & no Sb/Br)	CU NIPDAUAG	Level-2-260C-1 YEAR	
ADS8321E/2K5G4	ACTIVE	VSSOP	DGK	8	2500	Green (RoHS & no Sb/Br)	CU NIPDAUAG	Level-2-260C-1 YEAR	
ADS8321EB/250	ACTIVE	VSSOP	DGK	8	250	Green (RoHS & no Sb/Br)	CU NIPDAUAG	Level-2-260C-1 YEAR	
ADS8321EB/250G4	ACTIVE	VSSOP	DGK	8	250	Green (RoHS & no Sb/Br)	CU NIPDAUAG	Level-2-260C-1 YEAR	
ADS8321EB/2K5	ACTIVE	VSSOP	DGK	8	2500	Green (RoHS & no Sb/Br)	CU NIPDAUAG	Level-2-260C-1 YEAR	
ADS8321EB/2K5G4	ACTIVE	VSSOP	DGK	8	2500	Green (RoHS & no Sb/Br)	CU NIPDAUAG	Level-2-260C-1 YEAR	

<sup>(1)</sup> The marketing status values are defined as follows:

**ACTIVE:** Product device recommended for new designs.

**LIFEBUY:** TI has announced that the device will be discontinued, and a lifetime-buy period is in effect.

**NRND:** Not recommended for new designs. Device is in production to support existing customers, but TI does not recommend using this part in a new design.

**PREVIEW:** Device has been announced but is not in production. Samples may or may not be available.

**OBSOLETE:** TI has discontinued the production of the device.

<sup>(2)</sup> Eco Plan - The planned eco-friendly classification: Pb-Free (RoHS), Pb-Free (RoHS Exempt), or Green (RoHS & no Sb/Br) - please check <http://www.ti.com/productcontent> for the latest availability information and additional product content details.

**TBD:** The Pb-Free/Green conversion plan has not been defined.

**Pb-Free (RoHS):** TI's terms "Lead-Free" or "Pb-Free" mean semiconductor products that are compatible with the current RoHS requirements for all 6 substances, including the requirement that lead not exceed 0.1% by weight in homogeneous materials. Where designed to be soldered at high temperatures, TI Pb-Free products are suitable for use in specified lead-free processes.

**Pb-Free (RoHS Exempt):** This component has a RoHS exemption for either 1) lead-based flip-chip solder bumps used between the die and package, or 2) lead-based die adhesive used between the die and leadframe. The component is otherwise considered Pb-Free (RoHS compatible) as defined above.

**Green (RoHS & no Sb/Br):** TI defines "Green" to mean Pb-Free (RoHS compatible), and free of Bromine (Br) and Antimony (Sb) based flame retardants (Br or Sb do not exceed 0.1% by weight in homogeneous material)

<sup>(3)</sup> MSL, Peak Temp. -- The Moisture Sensitivity Level rating according to the JEDEC industry standard classifications, and peak solder temperature.

**Important Information and Disclaimer:** The information provided on this page represents TI's knowledge and belief as of the date that it is provided. TI bases its knowledge and belief on information provided by third parties, and makes no representation or warranty as to the accuracy of such information. Efforts are underway to better integrate information from third parties. TI has taken and continues to take reasonable steps to provide representative and accurate information but may not have conducted destructive testing or chemical analysis on incoming materials and chemicals. TI and TI suppliers consider certain information to be proprietary, and thus CAS numbers and other limited information may not be available for release.

In no event shall TI's liability arising out of such information exceed the total purchase price of the TI part(s) at issue in this document sold by TI to Customer on an annual basis.

**TAPE AND REEL INFORMATION**
**REEL DIMENSIONS**

**TAPE DIMENSIONS**

A0	Dimension designed to accommodate the component width
B0	Dimension designed to accommodate the component length
K0	Dimension designed to accommodate the component thickness
W	Overall width of the carrier tape
P1	Pitch between successive cavity centers

**TAPE AND REEL INFORMATION**

\*All dimensions are nominal

Device	Package Type	Package Drawing	Pins	SPQ	Reel Diameter (mm)	Reel Width W1 (mm)	A0 (mm)	B0 (mm)	K0 (mm)	P1 (mm)	W (mm)	Pin1 Quadrant
ADS8321E/250	VSSOP	DGK	8	250	330.0	12.4	5.3	3.4	1.4	8.0	12.0	Q1
ADS8321E/2K5	VSSOP	DGK	8	2500	330.0	12.4	5.3	3.4	1.4	8.0	12.0	Q1
ADS8321EB/250	VSSOP	DGK	8	250	330.0	12.4	5.3	3.4	1.4	8.0	12.0	Q1
ADS8321EB/2K5	VSSOP	DGK	8	2500	330.0	12.4	5.3	3.4	1.4	8.0	12.0	Q1

**TAPE AND REEL BOX DIMENSIONS**

\*All dimensions are nominal

Device	Package Type	Package Drawing	Pins	SPQ	Length (mm)	Width (mm)	Height (mm)
ADS8321E/250	VSSOP	DGK	8	250	367.0	367.0	35.0
ADS8321E/2K5	VSSOP	DGK	8	2500	367.0	367.0	35.0
ADS8321EB/250	VSSOP	DGK	8	250	367.0	367.0	35.0
ADS8321EB/2K5	VSSOP	DGK	8	2500	367.0	367.0	35.0



DGK (S-PDSO-G8)

PLASTIC SMALL-OUTLINE PACKAGE



- NOTES:
- A. All linear dimensions are in millimeters.
  - B. This drawing is subject to change without notice.
  - C. Body length does not include mold flash, protrusions, or gate burrs. Mold flash, protrusions, or gate burrs shall not exceed 0.15 per end.
  - D. Body width does not include interlead flash. Interlead flash shall not exceed 0.50 per side.
  - E. Falls within JEDEC MO-187 variation AA, except interlead flash.

## IMPORTANT NOTICE

Texas Instruments Incorporated and its subsidiaries (TI) reserve the right to make corrections, enhancements, improvements and other changes to its semiconductor products and services per JESD46C and to discontinue any product or service per JESD48B. Buyers should obtain the latest relevant information before placing orders and should verify that such information is current and complete. All semiconductor products (also referred to herein as "components") are sold subject to TI's terms and conditions of sale supplied at the time of order acknowledgment.

TI warrants performance of its components to the specifications applicable at the time of sale, in accordance with the warranty in TI's terms and conditions of sale of semiconductor products. Testing and other quality control techniques are used to the extent TI deems necessary to support this warranty. Except where mandated by applicable law, testing of all parameters of each component is not necessarily performed.

TI assumes no liability for applications assistance or the design of Buyers' products. Buyers are responsible for their products and applications using TI components. To minimize the risks associated with Buyers' products and applications, Buyers should provide adequate design and operating safeguards.

TI does not warrant or represent that any license, either express or implied, is granted under any patent right, copyright, mask work right, or other intellectual property right relating to any combination, machine, or process in which TI components or services are used. Information published by TI regarding third-party products or services does not constitute a license to use such products or services or a warranty or endorsement thereof. Use of such information may require a license from a third party under the patents or other intellectual property of the third party, or a license from TI under the patents or other intellectual property of TI.

Reproduction of significant portions of TI information in TI data books or data sheets is permissible only if reproduction is without alteration and is accompanied by all associated warranties, conditions, limitations, and notices. TI is not responsible or liable for such altered documentation. Information of third parties may be subject to additional restrictions.

Resale of TI components or services with statements different from or beyond the parameters stated by TI for that component or service voids all express and any implied warranties for the associated TI component or service and is an unfair and deceptive business practice. TI is not responsible or liable for any such statements.

Buyer acknowledges and agrees that it is solely responsible for compliance with all legal, regulatory and safety-related requirements concerning its products, and any use of TI components in its applications, notwithstanding any applications-related information or support that may be provided by TI. Buyer represents and agrees that it has all the necessary expertise to create and implement safeguards which anticipate dangerous consequences of failures, monitor failures and their consequences, lessen the likelihood of failures that might cause harm and take appropriate remedial actions. Buyer will fully indemnify TI and its representatives against any damages arising out of the use of any TI components in safety-critical applications.

In some cases, TI components may be promoted specifically to facilitate safety-related applications. With such components, TI's goal is to help enable customers to design and create their own end-product solutions that meet applicable functional safety standards and requirements. Nonetheless, such components are subject to these terms.

No TI components are authorized for use in FDA Class III (or similar life-critical medical equipment) unless authorized officers of the parties have executed a special agreement specifically governing such use.

Only those TI components which TI has specifically designated as military grade or "enhanced plastic" are designed and intended for use in military/aerospace applications or environments. Buyer acknowledges and agrees that any military or aerospace use of TI components which have **not** been so designated is solely at the Buyer's risk, and that Buyer is solely responsible for compliance with all legal and regulatory requirements in connection with such use.

TI has specifically designated certain components which meet ISO/TS16949 requirements, mainly for automotive use. Components which have not been so designated are neither designed nor intended for automotive use; and TI will not be responsible for any failure of such components to meet such requirements.

### Products

Audio	<a href="http://www.ti.com/audio">www.ti.com/audio</a>
Amplifiers	<a href="http://amplifier.ti.com">amplifier.ti.com</a>
Data Converters	<a href="http://dataconverter.ti.com">dataconverter.ti.com</a>
DLP® Products	<a href="http://www.dlp.com">www.dlp.com</a>
DSP	<a href="http://dsp.ti.com">dsp.ti.com</a>
Clocks and Timers	<a href="http://www.ti.com/clocks">www.ti.com/clocks</a>
Interface	<a href="http://interface.ti.com">interface.ti.com</a>
Logic	<a href="http://logic.ti.com">logic.ti.com</a>
Power Mgmt	<a href="http://power.ti.com">power.ti.com</a>
Microcontrollers	<a href="http://microcontroller.ti.com">microcontroller.ti.com</a>
RFID	<a href="http://www.ti-rfid.com">www.ti-rfid.com</a>
OMAP Mobile Processors	<a href="http://www.ti.com/omap">www.ti.com/omap</a>
Wireless Connectivity	<a href="http://www.ti.com/wirelessconnectivity">www.ti.com/wirelessconnectivity</a>

### Applications

Automotive and Transportation	<a href="http://www.ti.com/automotive">www.ti.com/automotive</a>
Communications and Telecom	<a href="http://www.ti.com/communications">www.ti.com/communications</a>
Computers and Peripherals	<a href="http://www.ti.com/computers">www.ti.com/computers</a>
Consumer Electronics	<a href="http://www.ti.com/consumer-apps">www.ti.com/consumer-apps</a>
Energy and Lighting	<a href="http://www.ti.com/energy">www.ti.com/energy</a>
Industrial	<a href="http://www.ti.com/industrial">www.ti.com/industrial</a>
Medical	<a href="http://www.ti.com/medical">www.ti.com/medical</a>
Security	<a href="http://www.ti.com/security">www.ti.com/security</a>
Space, Avionics and Defense	<a href="http://www.ti.com/space-avionics-defense">www.ti.com/space-avionics-defense</a>
Video and Imaging	<a href="http://www.ti.com/video">www.ti.com/video</a>

**TI E2E Community** [e2e.ti.com](http://e2e.ti.com)