

**Rocker/Paddle Switches, A Series, Part Number Matrix**

**MATERIAL SPECIFICATIONS:**

Contacts/Terminals .....Gold/gold flash  
 Silver/tin lead  
 Case Material .....Thermoset 94V-0  
 Actuator Material .....Polyamide  
 Terminal Seal .....Epoxy

**ENVIRONMENTAL SPECIFICATIONS:**

Operating Temperature.....-4°F to +185°F (-20°C to +85°C)  
 Storage Temperature.....-49°F to +212°F (-45°C to +100°C)

**TYPICAL PERFORMANCE CHARACTERISTICS:**

Contact Rating .....Gold: 0.4 VA @ 20 AC/DC  
 Silver: 2 A @ 250 VAC: 5 A @ 125 VAC  
 Silver: 2 A @ 30 VDC  
 Initial Contact Resistance .....30 Milliohms max.  
 Contact Timing .....Break-before-make  
 Insulation Resistance .....1,000 Megohms @ 500 VDC  
 Dielectric Strength .....1,000 Volts RMS @ sea level  
 Actuator Travel.....25°  
 Life Expectancy .....Up to 30,000 Cycles

**DESIGN**

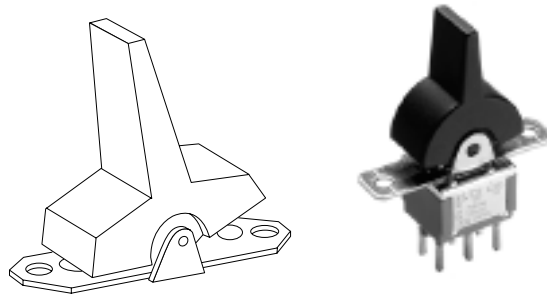
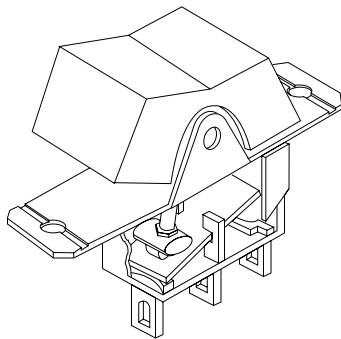

**PART NUMBERING**

Model	Function	Actuator	Terminal	Contact	Actuator Color	Beveled Frame Color	Option
<b>A1</b>	Single Pole	<b>J1</b> Small	<b>Z</b> Wire Lug	<b>Q</b> Silver	<b>0</b> Black (Std.)	<b>0</b> Black (Std.)	UL (Q or G) contacts only
<b>A2</b>	Double Pole	<b>J3</b> Large	<b>A</b> Right Angle	<b>B</b> Gold	<b>2</b> Red		
<b>01</b>	On-On	<b>J15</b> Snap-in	<b>AV2</b> Vert. Right Angle	<b>G</b> Gold over Silver			
<b>03</b>	On-Off-On	<b>J16</b> Snap-in w/beveled frame	<b>C</b> Printed Circuit				
<b>05</b>	(On)-Off-(On)	<b>J50</b> Snap-in	<b>V5</b> Vertical Right Angle				
		<b>J51</b> Snap-in w/beveled frame	<b>V3</b> <b>V4</b> Vertical Support Bracket				
		<b>J52</b> Snap-in w/beveled frame LED	<b>W</b> Wire Wrap				
		<b>J2</b> Small	<b>Z3</b> Quick Connect				
		<b>J4</b> Large					
		<b>J5</b> Large					
		<b>J60</b> Snap-in					
		<b>J61</b> Snap-in w/beveled frame					
		<b>J62</b> Snap-in w/beveled frame & LED					

**OPTIONAL:**  
 UL recognized under the Component Program of Underwriters Laboratories Inc. File # E46765  
 CSA Certified File #LR65901



**Rocker/Paddle Switches, A Series, Options**

**FUNCTIONS**

The following functions available in SP or DP.

- 01** 2 Positions None indicates no mechanical position
  - 03** 3 Positions Off indicates a mechanical position with no electrical connection.
  - 05** 3 Positions (On) indicates momentary operation.
- SPDT, connect terminals:  
DPDT, connect terminals:

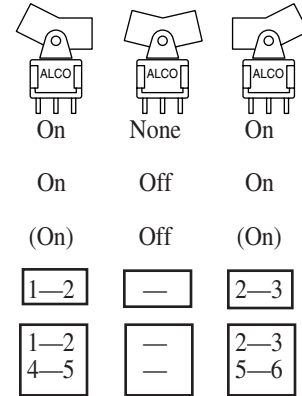

**ACTUATORS**

**J1** Rockers

Small

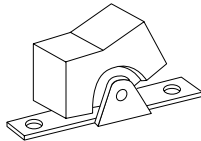

Mounting Type Standard with C or Z Terminal Type

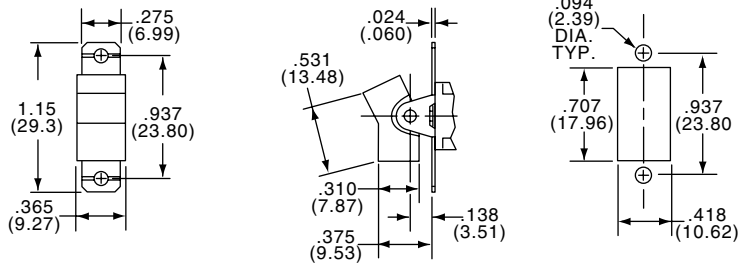

**J3**

Large

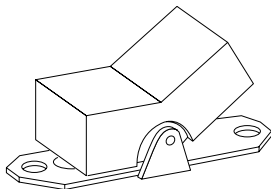

Mounting Type Standard with C or Z Terminal Type

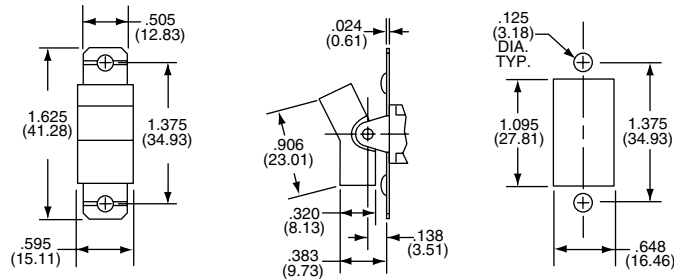

F

Gemini Series Rocker/Paddle Switches

**Rocker/Paddle Switches, A Series, Options**

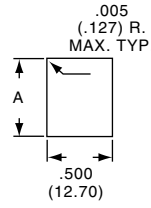
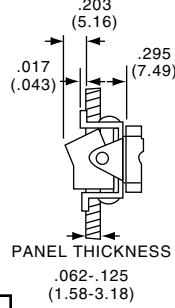
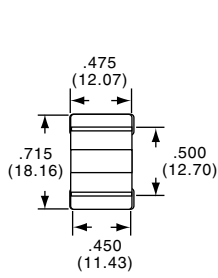

**ROCKER**



Snap-in

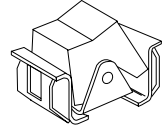

	Panel Opening		
Panel Thickness	.062	.093	.125
"A"	.600-.605	.610-.615	.620-.625

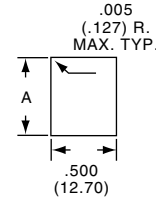
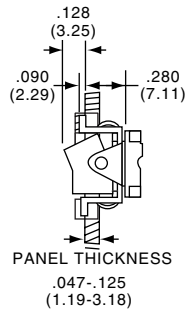
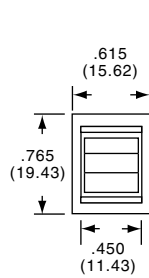

**Snap-in with beveled frame**

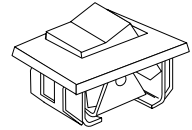

	Panel Opening		
Panel Thickness	.062	.093	.125
"A"	.600-.605	.610-.615	.620-.625

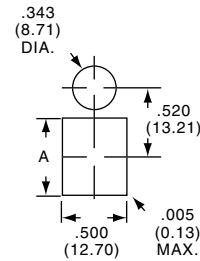
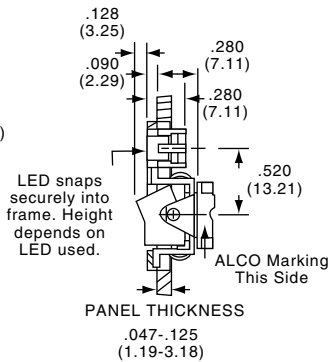
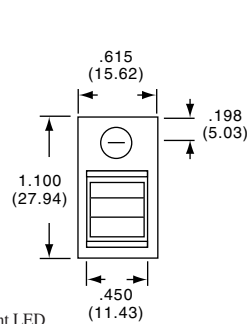

**Snap-in with beveled frame/L.E.D.**

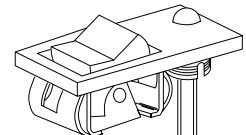

L.E.D. Not supplied.

Accepts BL-17 or equivalent LED

	Panel Opening		
Panel Thickness	.062	.093	.125
"A"	.600-.605	.610-.615	.620-.625

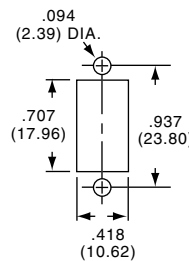
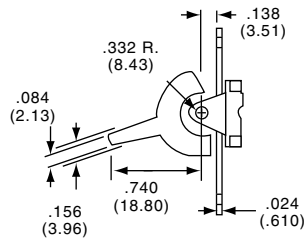
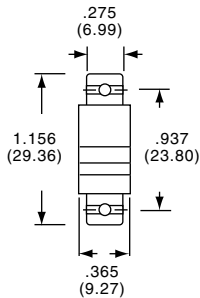

**PADDLE**



Small

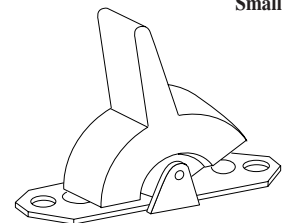

Mounting Type Standard with C or Z Terminal Type.

**Rocker/Paddle Switches, A Series, Options**

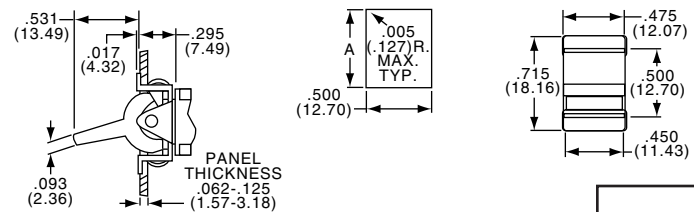
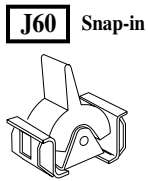
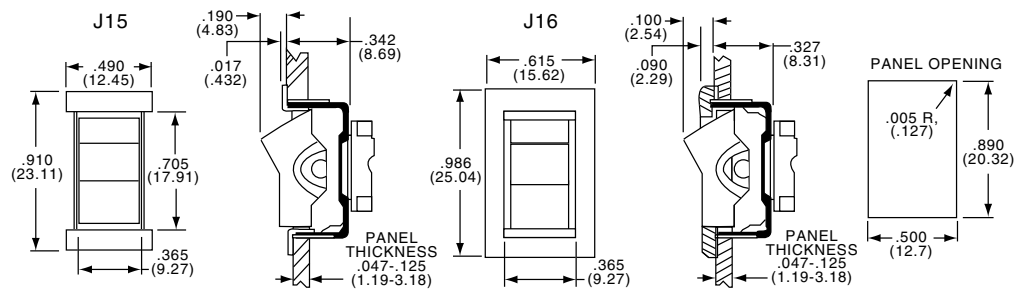
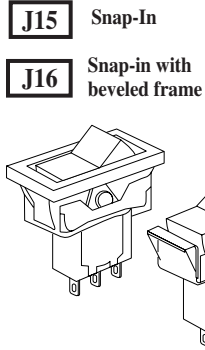
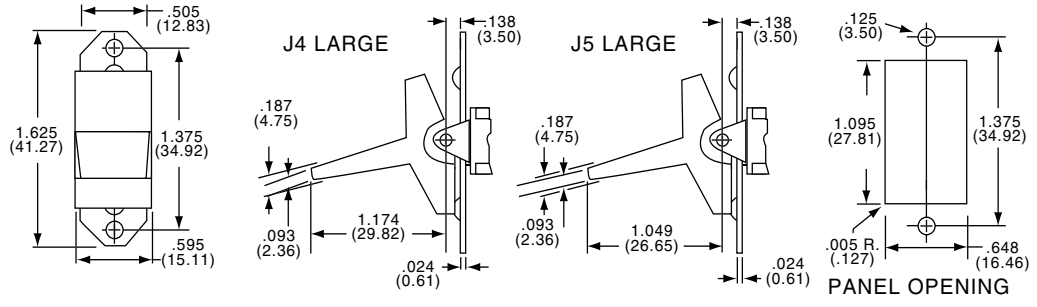
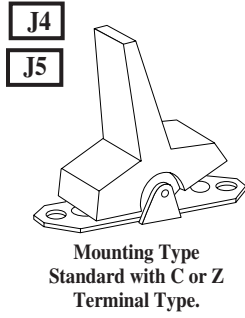

Panel Opening			
Panel Thickness	.062	.093	.125
"A"	.600-.605	.610-.615	.620-.625

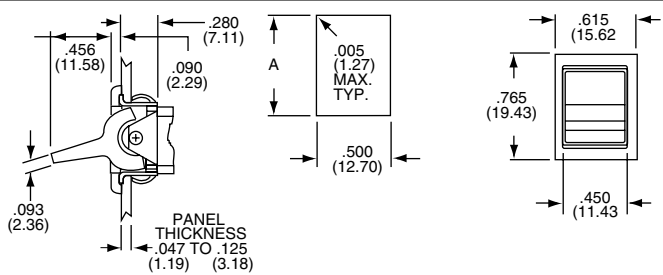
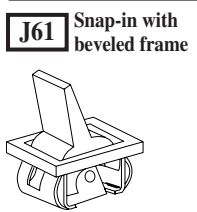

Panel Opening			
Panel Thickness	.062	.093	.125
"A"	.600-.605	.610-.615	.620-.625

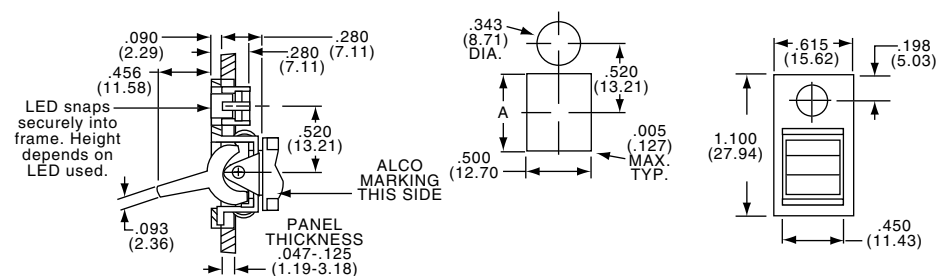
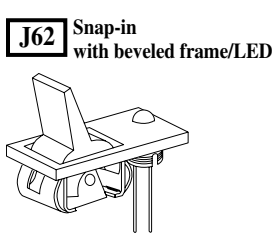

Panel Opening			
Panel Thickness	.062	.093	.125
"A"	.600-.605	.610-.615	.620-.625

Accepts BL-17 or equivalent LED  
L.E.D. not supplied

F

Gemini Series Rocker/Paddle Switches

**Rocker/Paddle Switches, A Series, Termination Options**

TERMINALS

**Z**

Wire Lug Standard

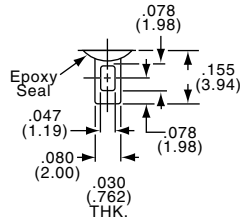

**Q**

Quick Connect

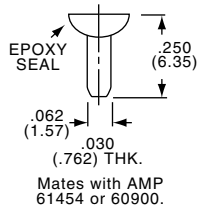

**W**

Wire Wrap

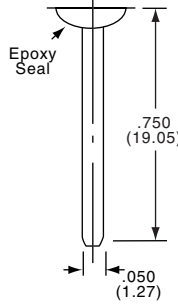

**C**

Printed Circuit

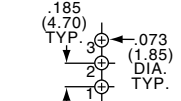
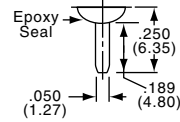

SINGLE POLE

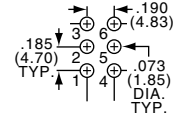

DOUBLE POLE

**A**

Right Angle Single Pole

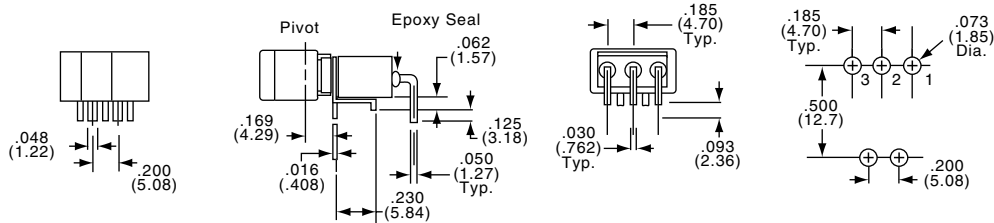

NOTE: Terminal numbers viewed from top of P.C. board.

**A**

Right Angle Double Pole

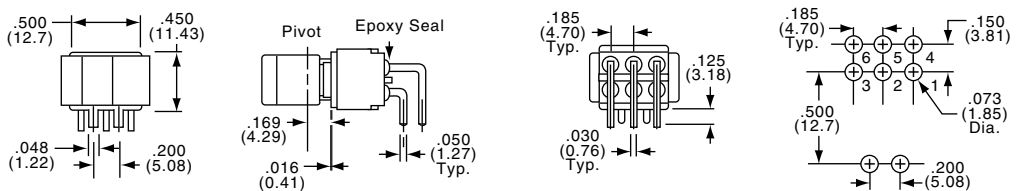

NOTE: Terminal numbers viewed from top of P.C. board.

**Rocker/Paddle Switches, A Series, Options**

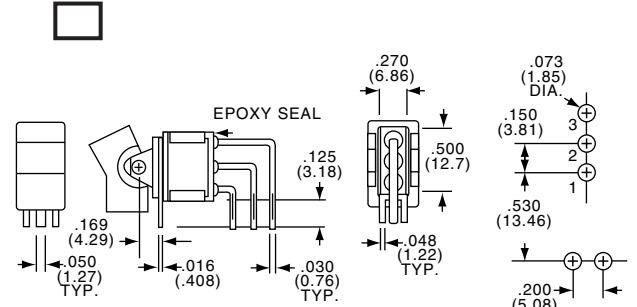
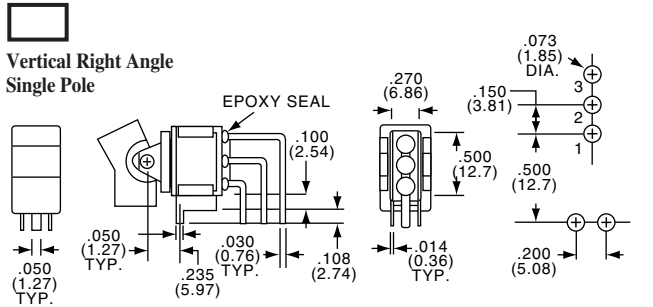

NOTE: Terminal numbers viewed from top of P.C. board.

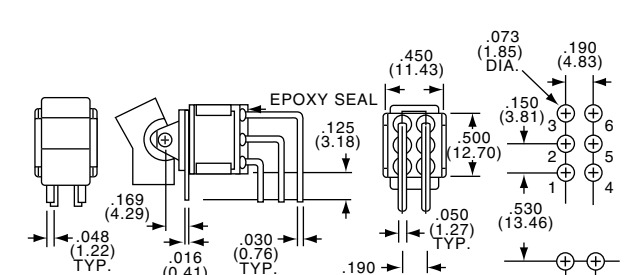
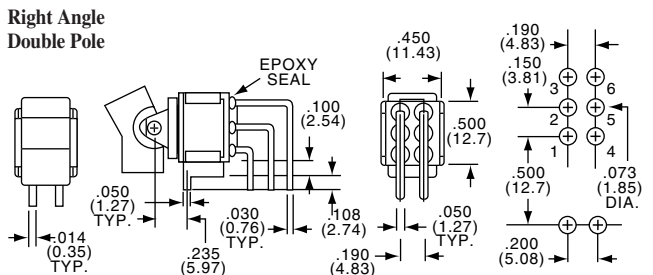

NOTE: Terminal numbers viewed from top of P.C. board.

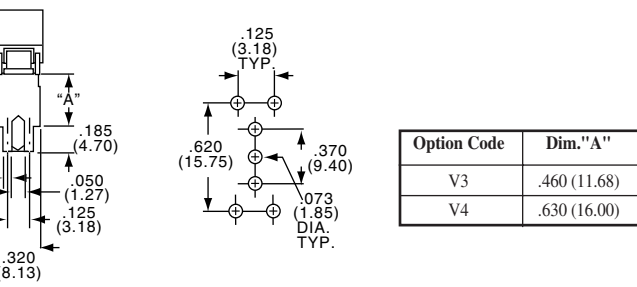
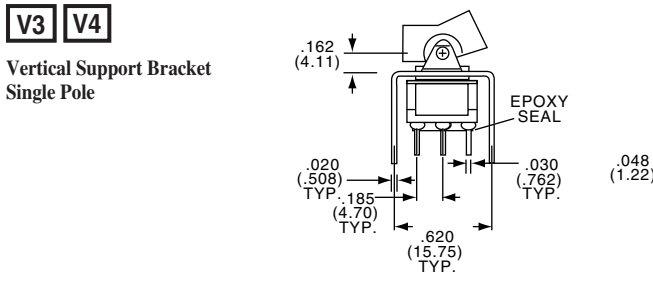

Option Code	Dim. "A"
V3	.460 (11.68)
V4	.630 (16.00)

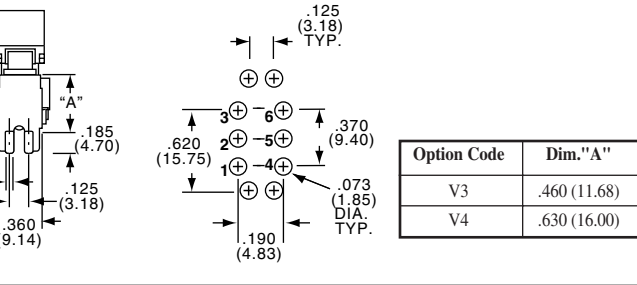
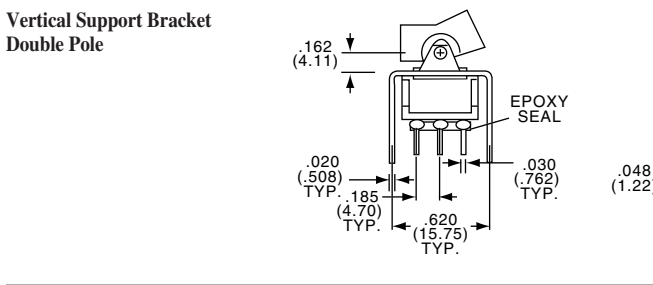

Option Code	Dim. "A"
V3	.460 (11.68)
V4	.630 (16.00)

**CONTACTS**

**B** CONTACTS: Copper alloy with gold plate, welded button.

TERMINALS: Copper alloy with gold plate.

ELECTRICAL RATING: 0.4VA @ 20 VAC/DC.

**Q** CONTACTS: Copper alloy with silver, welded button.

TERMINALS: Copper alloy with tin/lead plate.

ELECTRICAL RATING: 5 A @ 125 VAC, 2 A @ 250 VAC, 2 A @ 30 VDC. UL/CSA RATING: 5A @ 125 VAC, 3 @ 250 VAC (Specify "UL" option code)

**G** CONTACTS: Copper alloy with gold plate over silver, welded button.

TERMINALS: Copper alloy with gold plate.

ELECTRICAL RATING: 0.4 VA @ 20 VAC/DC or 5 A @ 125 VAC, 2 A @ 250 VAC, 2 A @ 30 VDC.

Note: This contact option can be used for low-level or power switching. If level is above 0.4 VA @ 20 VAC/DC, the switch is rendered usable only for power switching due to arc-removal of gold plate.

UL/CSA RATING: 5A @ 125 VAC, 3 @ 250 VAC (Specify "UL" option code)

F

Gemini Series Rocker/Paddle Switches

**Rocker Switches, A Series, PC Tail, Straight or Vertical Right Angle**

\* Refer to Pages F7 for Product Specifications and Part Matrix

SPDT



A101J1AV2Q0

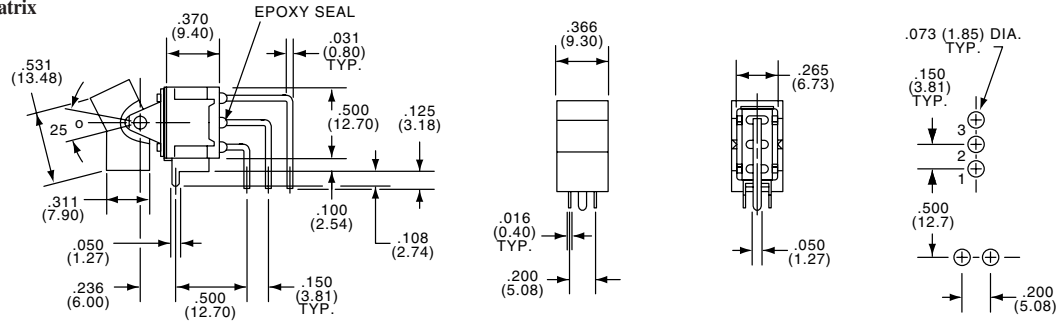

DPDT



A205J1AV2Q0

Standard Rocker Color - (Black)

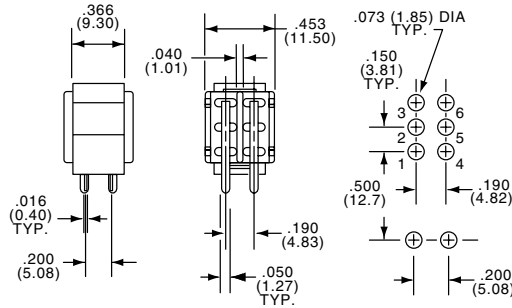

Silver Contacts							
Tyco Electronics	Alcoswitch	Type	Act. Code.	P. M5			
1-1437591-1	A101J1AV2Q0	SPDT	1		On	None	On
4-1437591-7	A105J1AV2Q0	SPDT	5		(On)	Off	(On)
7-1437591-1	A201J1AV2Q0	DPDT	2		On	None	On
9-1437591-6	A205J1AV2Q0	DPDT	6		(On)	Off	(On)

SPDT



A101J1CQ0

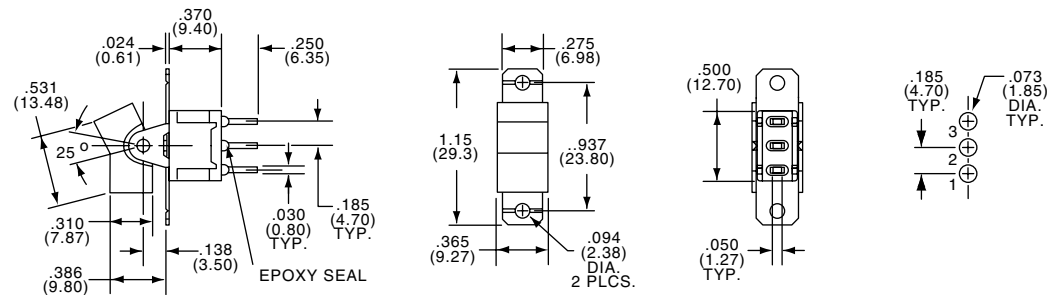

DPDT

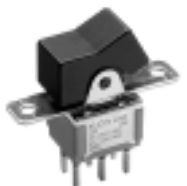

A201J1CQ0

Standard Rocker Color - (Black)

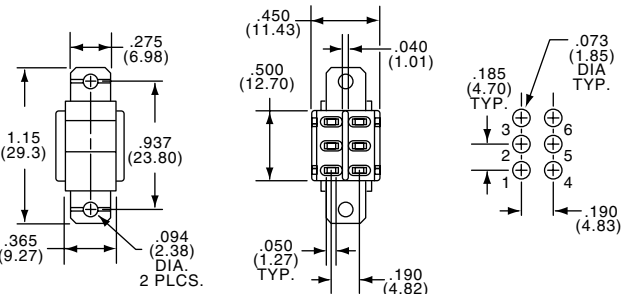

Silver Contacts							
Tyco Electronics	Alcoswitch	Type	Act. Code.	P. M5			
1-1437591-3	A101J1CQ0	SPDT	1		On	None	On
4-1437591-8	A105J1CQ0	SPDT	5		(On)	Off	(On)
7-1437591-2	A201J1CQ0	DPDT	2		On	None	On
—	A203J1CQ0	DPDT	2		On	Off	On
—	A205J1CQ0	DPDT	6		(On)	Off	(On)

**Rocker Switches, A Series, Wire Lug or Right Angle**

SEE PAGE F7 FOR PRODUCT SPECIFICATIONS AND PART MATRIX

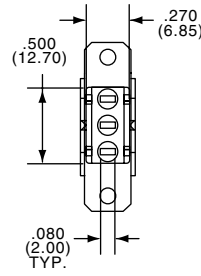
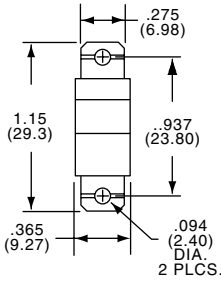
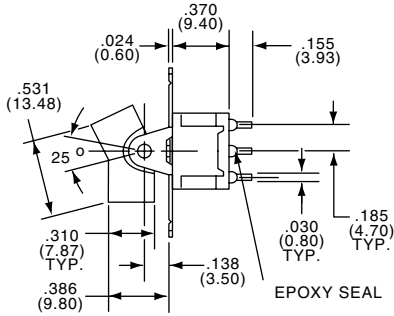

SPDT



A101J1ZQ0

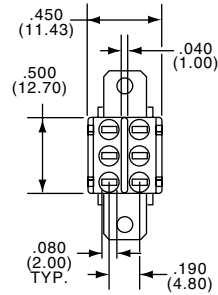
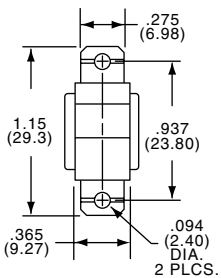

DPDT



A201J1ZQ0

Standard Rocker Color - (Black)

Silver Contacts							Silver Contacts								
Tyco Electronics	Alcoswitch	Type	Act. Code.	P. M5				Tyco Electronics	Alcoswitch	Type	Act. Code.	P. M5			
1-1437591-7	A101J1ZQ0	SPDT	1		On	None	On	7-1437591-4	A201J1ZQ0	DPDT	2		On	None	On
3-1437591-8	A103J1ZQ0	SPDT	5		On	Off	On	9-1437591-1	A203J1ZQ0	DPDT	6		On	Off	On
5-1437591-0	A105J1ZQ0	SPDT	5		(On)	Off	(On)	9-1437591-7	A205J1ZQ0	DPDT	6		(On)	Off	(On)

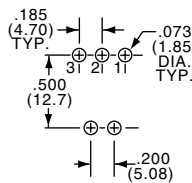
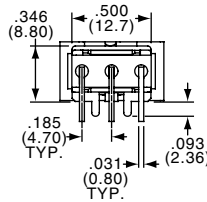
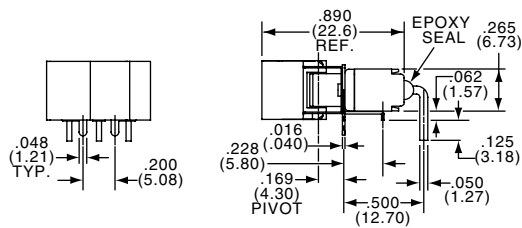

SPDT



A101J1AQ0

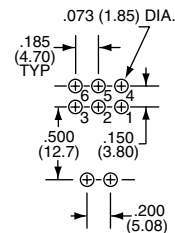
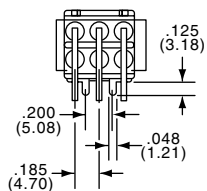
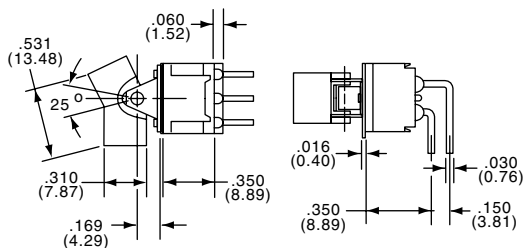

DPDT



A201J1AQ0

Standard Rocker Color - (Black)

Silver Contacts							Silver Contacts								
Tyco Electronics	Alcoswitch	Type	Act. Code.	P. M5				Tyco Electronics	Alcoswitch	Type	Act. Code.	P. M5			
1-1437591-8	A101J1AQ0	SPDT	1		On	None	On	6-1437591-9	A201J1AQ0	DPDT	2		On	None	On
4-1437591-6	A105J1AQ0	SPDT	5		(On)	Off	(On)	8-1437591-7	A203J1AQ0	DPDT	6		On	Off	On
								—	A205J1AQ0	DPDT	6		(On)	Off	(On)

F

Gemini Series Rocker/Paddle Switches



\* Refer to Pages F7 for Product Specifications and Part Matrix

**Paddle Switches, A Series, Wire Lug or Right Angle**

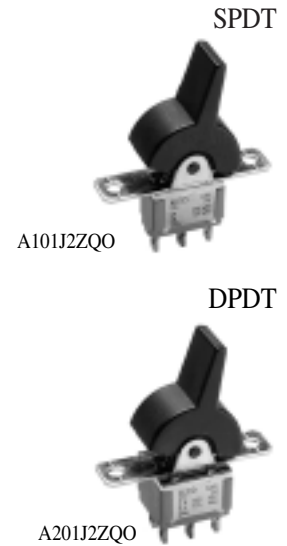
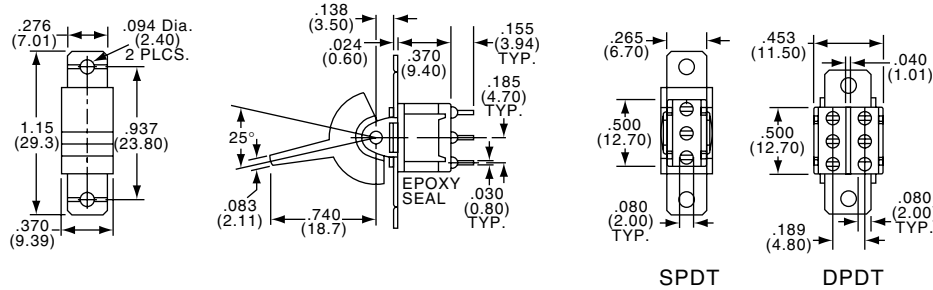

Standard Paddle Color - (Black)

Silver Contacts Tyco Electronics	Alcoswitch	Type	Act.	Code	P. M5	On	None	On	Silver Contacts Tyco Electronics	Alcoswitch	Type	Act.	Code	P. M5	On	None	On
1-1437591-9	A101J2ZQ0	SPDT	1			On	None	On	7-1437591-6	A201J2ZQ0	DPDT	2			On	None	On
4-1437591-0	A103J2ZQ0	SPDT	5			On	Off	On	—	A203J2ZQ0	DPDT	6			On	Off	On
5-1437591-3	A105J2ZQ0	SPDT	5			(On)	Off	(On)	9-1437591-9	A205J2ZQ0	DPDT	6			(On)	Off	(On)

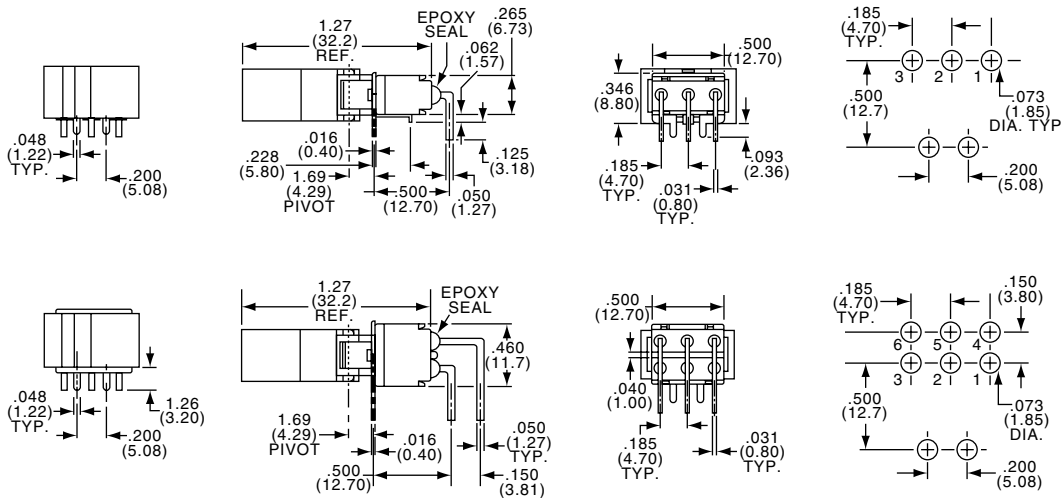

Standard Paddle Color - (Black)

Silver Contacts Tyco Electronics	Alcoswitch	Type	Act.	Code	P. M5	On	None	On	Silver Contacts Tyco Electronics	Alcoswitch	Type	Act.	Code	P. M5	On	None	On
—	A101J2AQ0	SPDT	1			On	None	On	—	A201J2AQ0	DPDT	2			On	None	On
—	A103J2AQ0	SPDT	5			On	Off	On	—	A203J2AQ0	DPDT	6			On	Off	On
5-1437591-1	A105J2AQ0	SPDT	5			(On)	Off	(On)	—	A205J2AQ0	DPDT	6			(On)	Off	(On)

**Paddle Switches, A Series, PC Tail, Straight or Vertical Right Angle**

SEE PAGE F7 FOR PRODUCT SPECIFICATIONS AND PART MATRIX

SPDT / DPDT

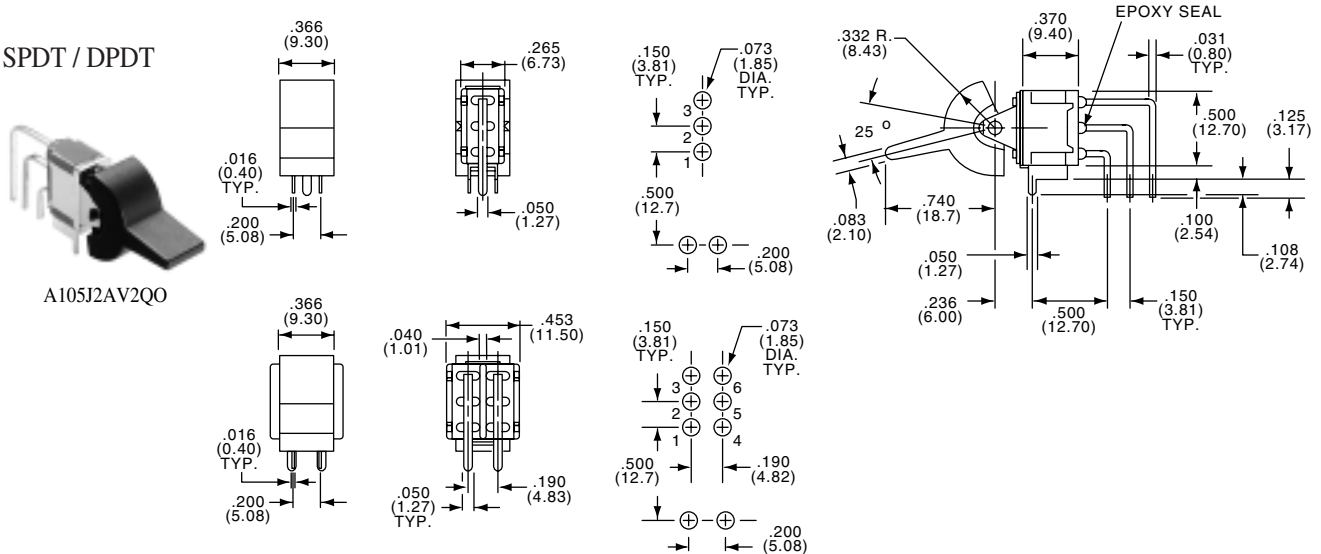

A105J2AV2Q0

F

Standard Paddle Color - (Black)

Silver Contacts							Silver Contacts								
Tyco Electronics	Alcoswitch	Type	Act. Code	P. M5	On	None	On	Tyco Electronics	Alcoswitch	Type	Act. Code	P. M5	On	None	On
1-1437591-8	A101J2AV2Q0	SPDT	1	On	None	On		—	A201J2AV2Q0	DPDT	2	On	None	On	
5-1437591-2	A105J2AV2Q0	SPDT	5	(On)	(Off)	(On)									

SPDT



A105J2CQ0

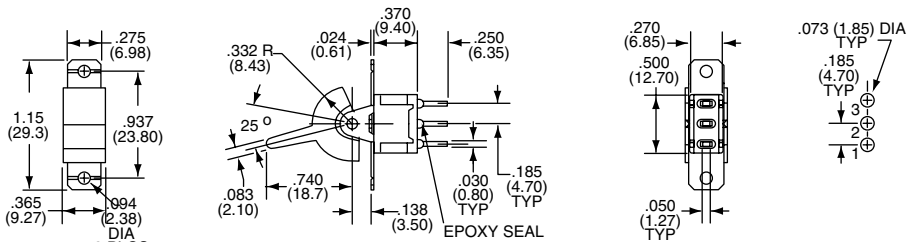

DPDT



A205J2CQ0

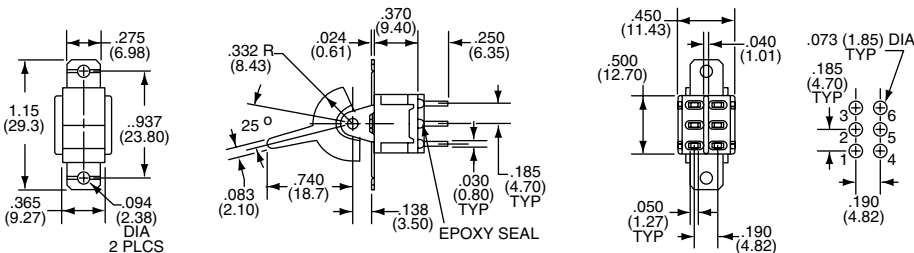

Silver Contacts							Silver Contacts								
Tyco Electronics	Alcoswitch	Type	Act. Code	P. M5	On	None	On	Tyco Electronics	Alcoswitch	Type	Act. Code	P. M5	On	None	On
—	A103J2CQ0	SPDT	5	(On)	(Off)	(On)		7-1437591-5	A201J2CQ0	DPDT	2	On	None	On	
—	A105J2CQ0	SPDT	5	(On)	(Off)	(On)		9-1437591-8	A205J2CQ0	DPDT	6	(On)	(Off)	(On)	



**Rocker/Paddle Switches, AE Series, Process Sealed, Options**

**FUNCTIONS**

The following functions available in SP or DP.

- 01** 2 Positions None indicates no mechanical position
  - 03** 3 Positions Off indicates a mechanical position with no electrical connection.
  - 05** 3 Positions (On) indicates momentary operation
- SPDT, connect terminals:  
 DPDT, connect terminals:

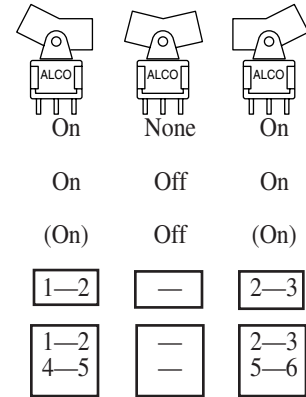

**J1**  
Rocker

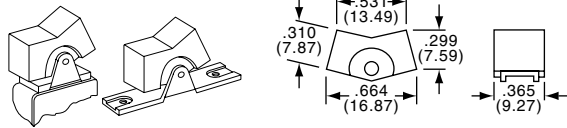

Mounting Provided with C or Z Terminal Type.

**ACTUATORS**

**J50**  
Rocker

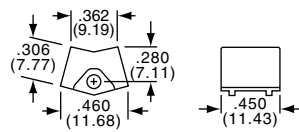

Mounting Provided with C or Z Terminal Type.

**J2**  
Paddle

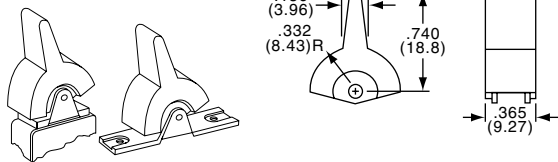

Mounting Provided with C or Z Terminal Type.

**J60**  
Paddle

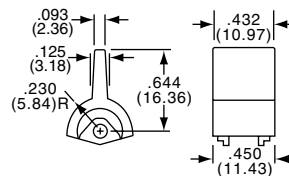

Mounting Provided with C or Z Terminal Type.

F

Gemini Series Rocker/Paddle Switches