

Intelligent Power Module (R-Series)

Maximum Ratings and Characteristics

Absolute Maximum Ratings (T_c=25°C)

Items	Symbols	Ratings		Units
		Min.	Max.	
DC Bus Voltage	V _{DC}	0	450	V
DC Bus Voltage (surge)	V _{DC(Surge)}	0	500	
DC Bus Voltage (short operating)	V _{SC}	200	400	
Collector-Emitter Voltage	V _{CEs}	0	600	
Inverter Collector Current	Continuous	I _C	150	A
	1ms	I _{CP}	300	
	Duty=58.8%	-I _C	150	
Collector Power Dissipation	P _C (One Transistor)		595	W
Dynamic Brake Collector Current	Continuous	I _C	50	A
	1ms	I _{CP}	100	
Forward Current of Diode	I _F		50	
Collector Power Dissi. DB	P _C (One Transistor)		198	W
Voltage of Power Supply for Driver	V _{CC} *1	0	20	V
Input Signal Voltage	V _{IN} *2	0	V _Z	V
Input Signal Current	I _{IN}		1	mA
Alarm Signal Voltage	V _{ALM} *3	0	V _{CC}	V
Alarm Signal Current	I _{ALM} *4		15	mA
Junction Temperature	T _J		150	°C
Operating Temperature	T _{OP}	-20	100	
Storage Temperature	T _{stg}	-40	125	
Isolation Voltage	V _{iso} (A.C. 1min.)		2500	V
Screw Torque	Mounting *1		3.5	Nm
	Terminals *1		3.5	

Note: *1: Recommendable Value; 2.5 - 3.0 Nm (M5)

Outline Drawing

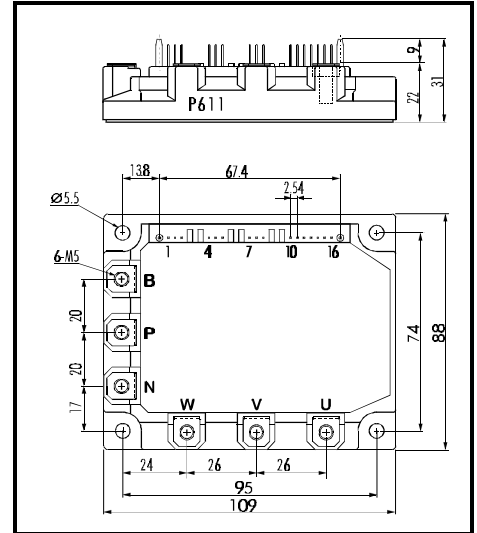

Fig. 1

Electrical Characteristics of Power Circuit (at T_J=25°C, V_{CC}=15V)

Items	Symbols	Conditions	Min.	Typ.	Max.	Units
INV	Collector Current At Off Signal Input	I _{CEs}	V _{CE} =600V, Input Terminal Open		1.0	mA
	Collector-Emitter Saturation Voltage	V _{CE(Sat)}	I _C =150A		2.8	V
	Forward Voltage of FWD	V _F	-I _C =150A		3.0	V
DB	Collector Current At Off Signal Input	I _{CEs}	V _{CE} =600V, Input Terminal Open		1.0	mA
	Collector-Emitter Saturation Voltage	V _{CE(Sat)}	I _C =50A		2.8	V
	Forward Voltage of FWD	V _F	-I _C =50A		3.3	V

Electrical Characteristics of Control Circuit (at T_J=25°C, V_{CC}=15V)

Items	Symbols	Conditions	Min.	Typ.	Max.	Units
Current of P-Line Side Driver (One Unit)	I _{CCP}	f _{SW} =0~15kHz, T _C =-20~100°C	3		18	mA
Current of N-Line Side Driver (Three Units)	I _{CCN}	f _{SW} =0~15kHz, T _C =-20~100°C	10		65	
Input Signal Threshold Voltage	V _{IN(th)}	On	1.00	1.35	1.70	V
		Off	1.25	1.60	1.95	
Input Zener Voltage	V _Z	R _{IN} =20kΩ		8.0		
Over Heating Protection Temperature Level	T _{COH}	V _{DC} =0V, I _C =0A, Case Temp.	110		125	°C
Hysteresis	T _{CH}			20		
IGBT Chips Over Heating Protec. Temp. Level	T _{JOH}	Surface of IGBT Chip	150			
Hysteresis	T _{JH}			20		
Inverter Collector Current Protection Level	I _{OC}	T _J =125°C	225			A
DB Collector Current Protection Level	I _{OC}	T _J =125°C	75			
Over Current Detecting Time	t _{DOC}	T _J =25°C		10		μs
Alarm Signal Hold Time	t _{ALM}		1.5	2		ms
Limiting Resistor for Alarm	R _{ALM}		1425	1500	1575	Ω
Under Voltage Protection Level	V _{UV}		11.0		12.5	V
Hysteresis	V _H		0.2			

Dynamic Characteristics (at T_C=T_J=125°C, V_{CC}=15V)

Items	Symbols	Conditions	Min.	Typ.	Max.	Units
Switching Time	t _{ON}	I _C =150A, V _{DC} =300V	0.3			μs
	t _{OFF}				3.6	
	t _{RR}	I _F =150A, V _{DC} =300V			0.4	

• Thermal Characteristics

Items	Symbols	Conditions	Min.	Typ.	Max.	Units
Thermal Resistance	$R_{th(i-c)}$	Inverter IGBT			0.21	°C/W
	$R_{th(i-c)}$	Diode			0.47	
	$R_{th(i-c)}$	DB IGBT			0.63	
	$R_{th(c-f)}$	With Thermal Compound		0.05		

■ Equivalent Circuit

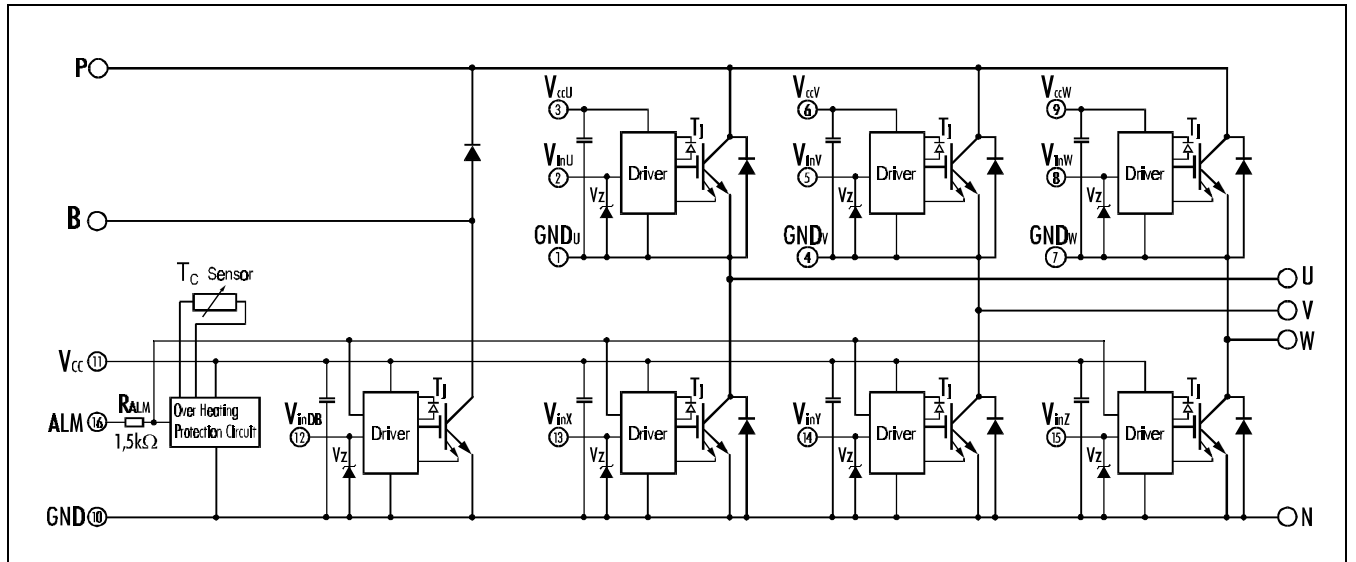

Drivers include following functions

- Short circuit protection circuit
- Amplifier for driver
- Undervoltage protection circuit
- Overcurrent protection circuit
- IGBT Chip overheating protection

Dynamic Brake

Collector Current vs. Collector-Emitter Voltage

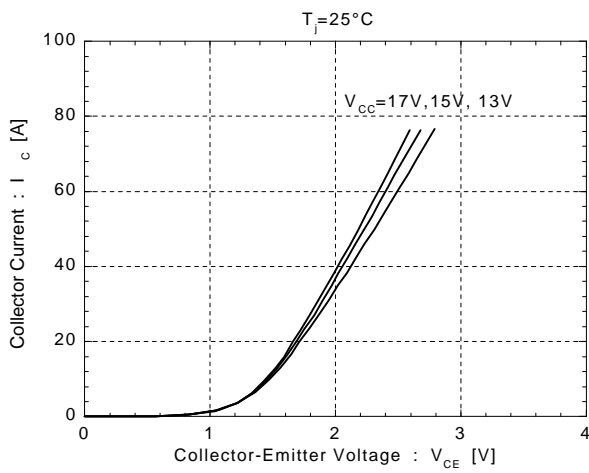

Collector Current vs. Collector-Emitter Voltage

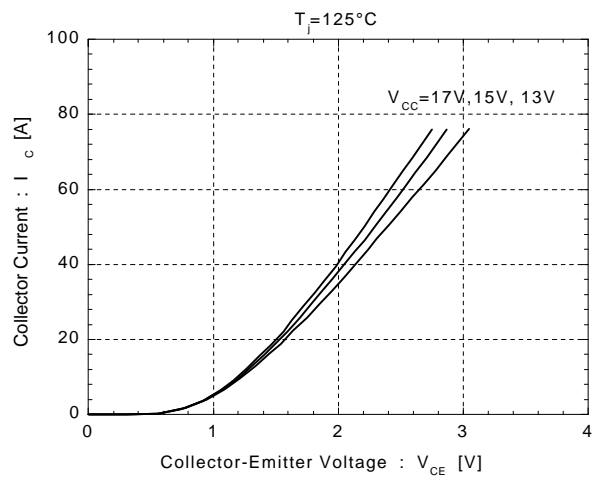

Transient Thermal Resistance

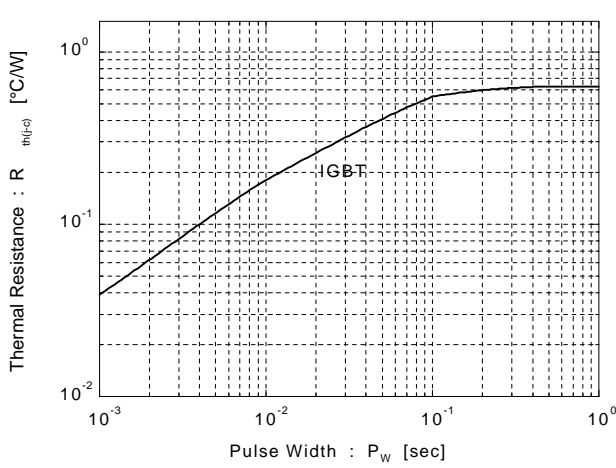

Reverse Biased Safe Operating Area

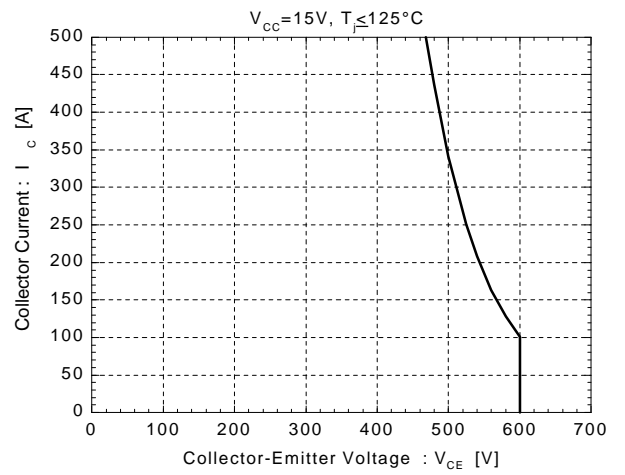

Power Derating For IGBT
(per device)

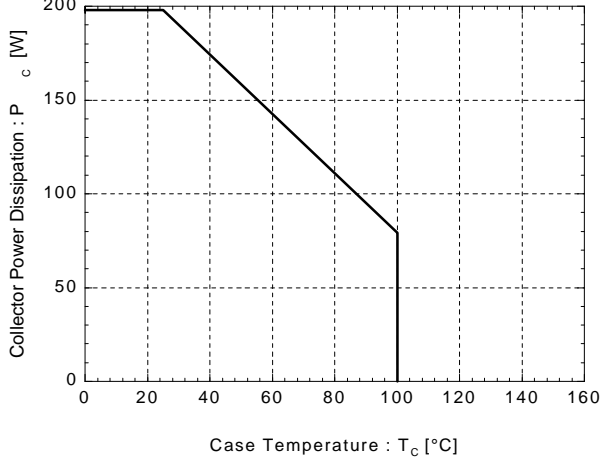

Over Current Protection vs. Junction Temperature

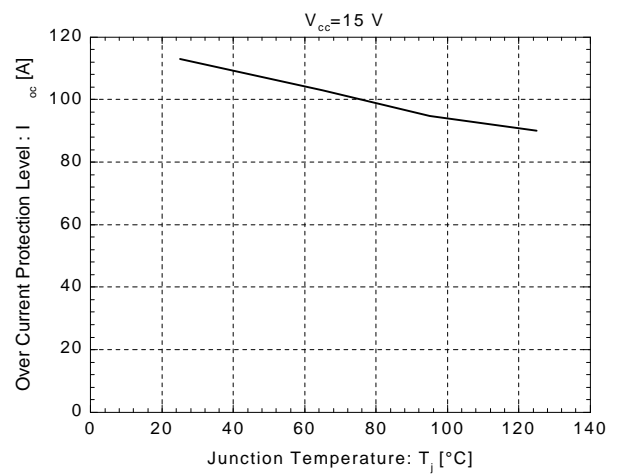

Control Circuit

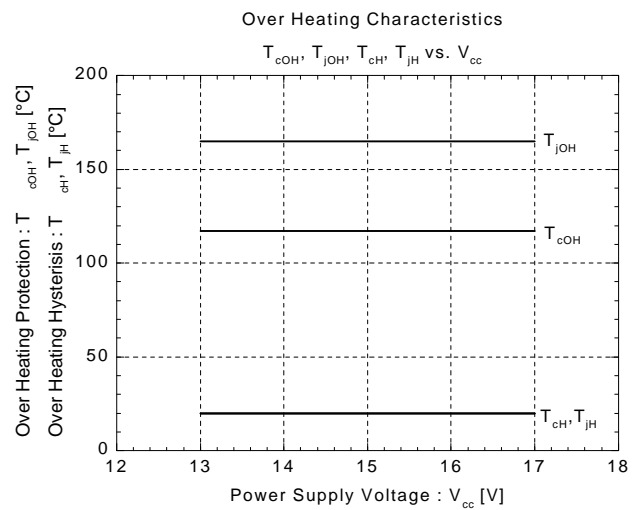
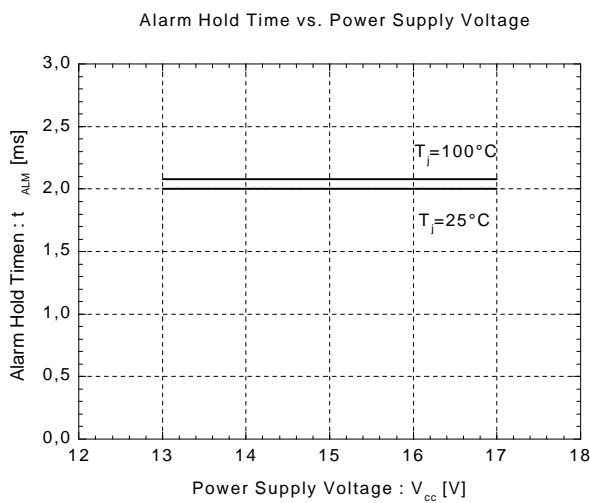
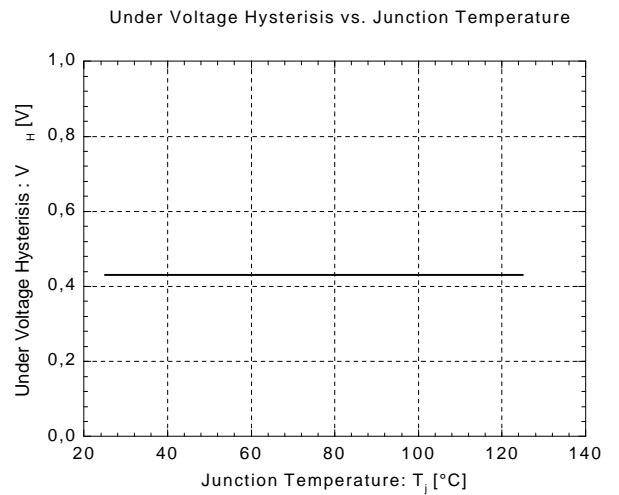
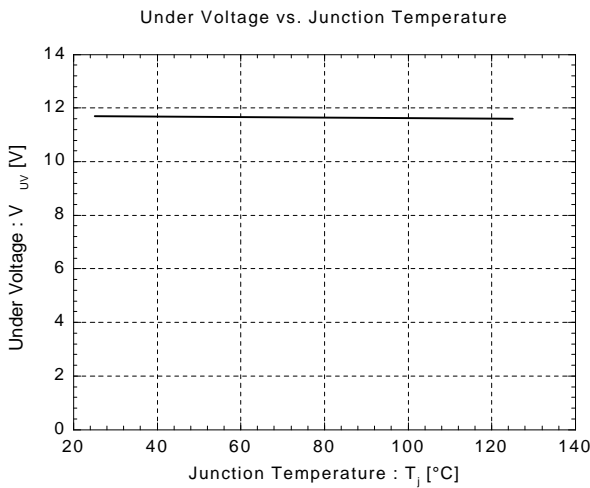
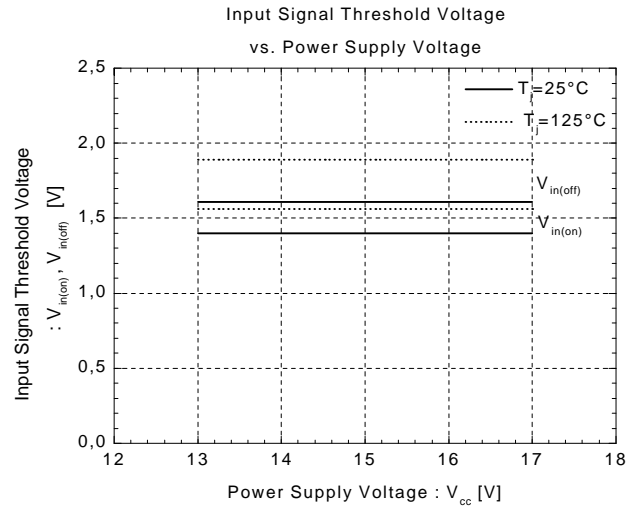
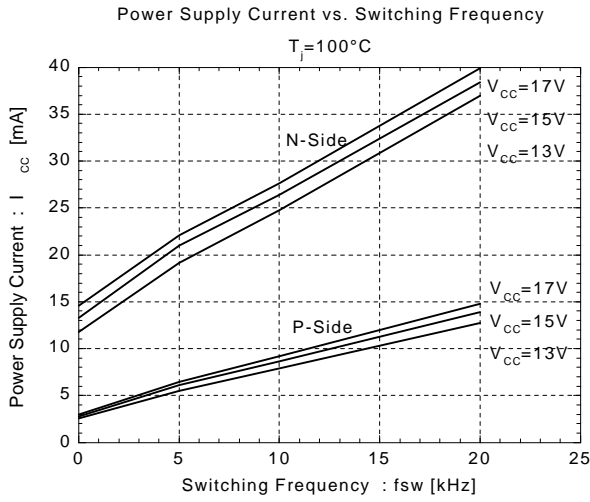

■ Inverter

Collector Current vs. Collector-Emitter Voltage

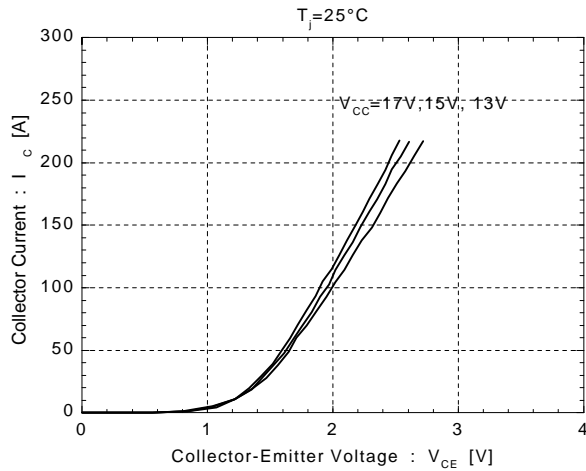

Collector Current vs. Collector-Emitter Voltage

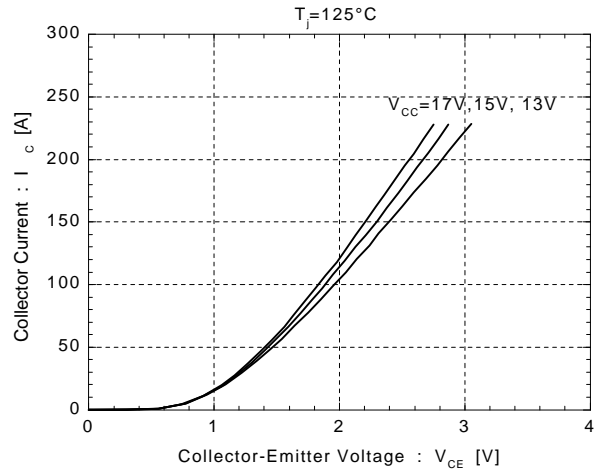

Switching Time vs. Collector Current

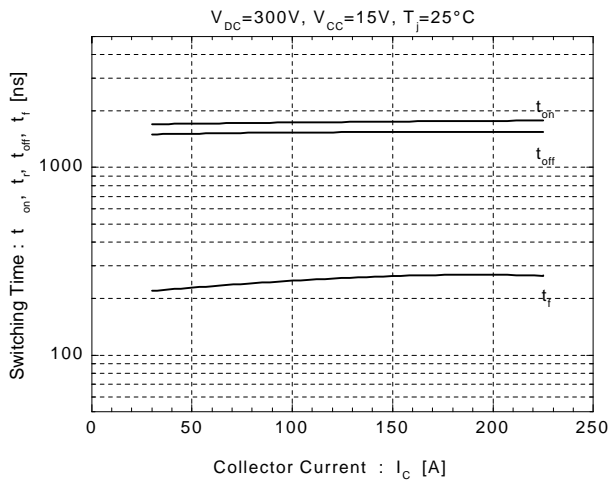

Switching Time vs. Collector Current

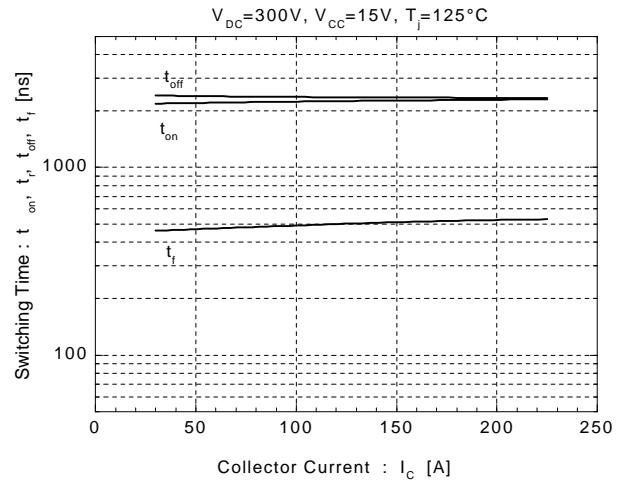

Forward Voltage vs. Forward Current

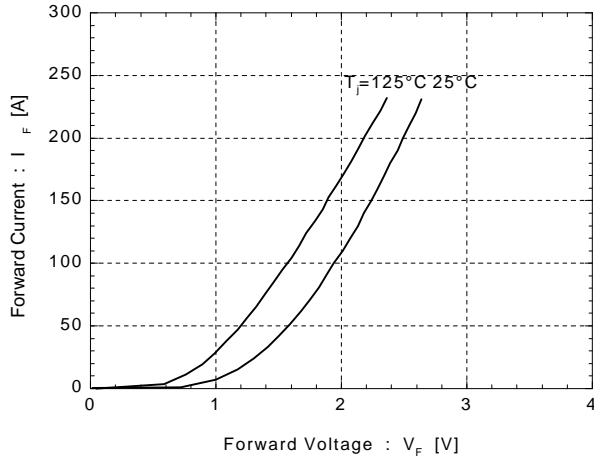

Reverse Recovery Characteristics

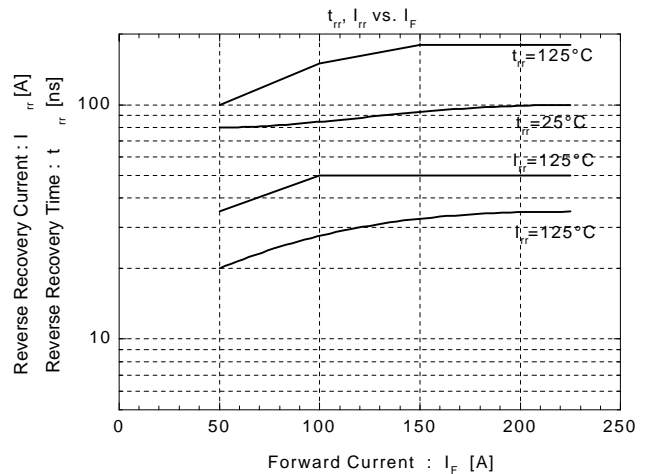

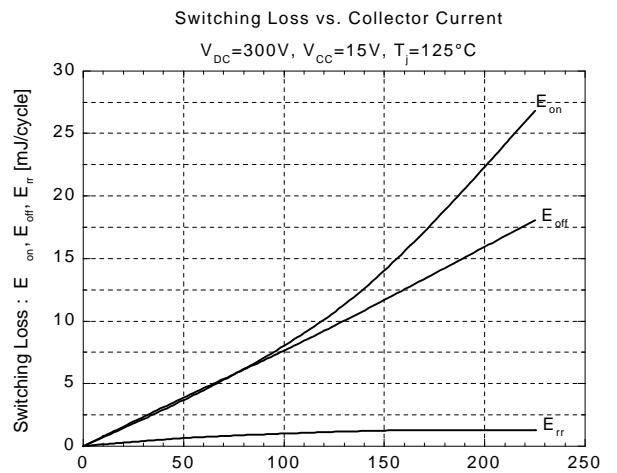
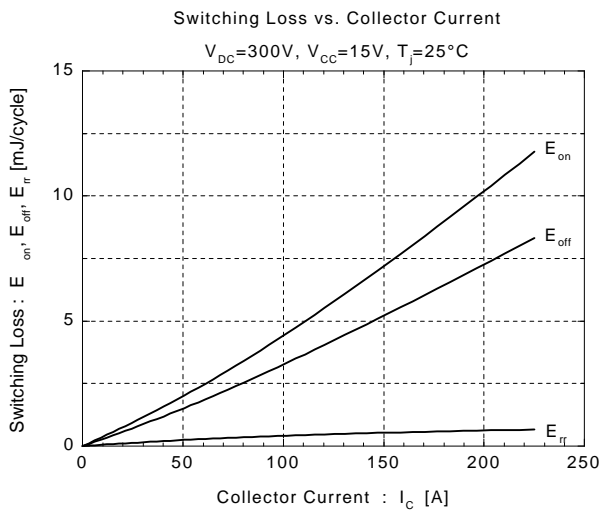
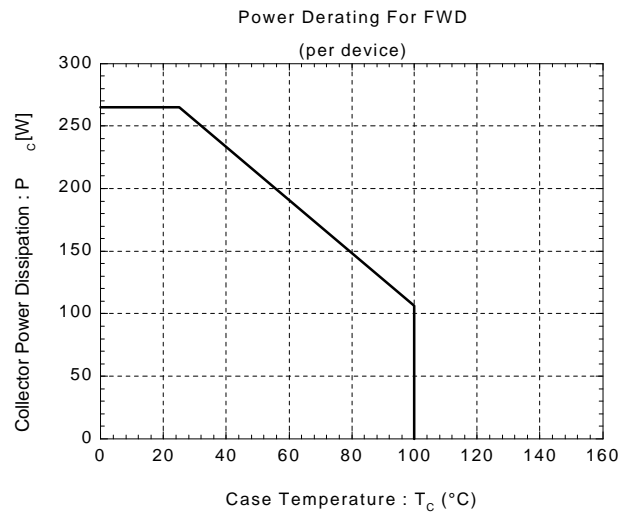
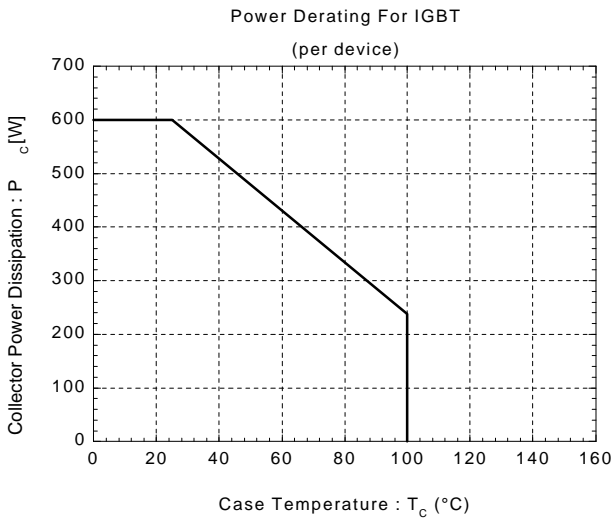
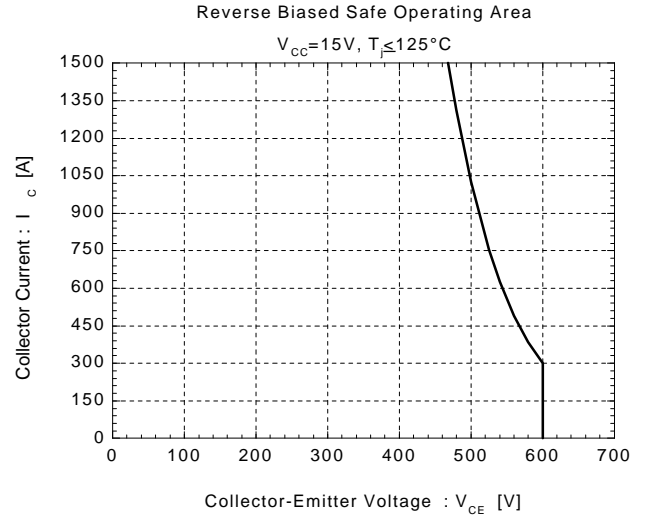
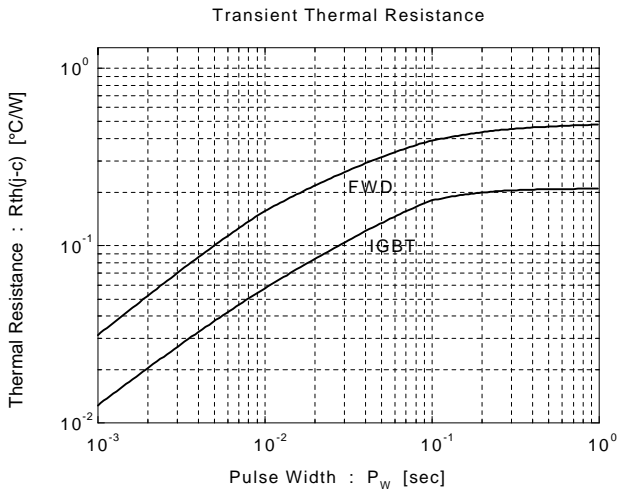

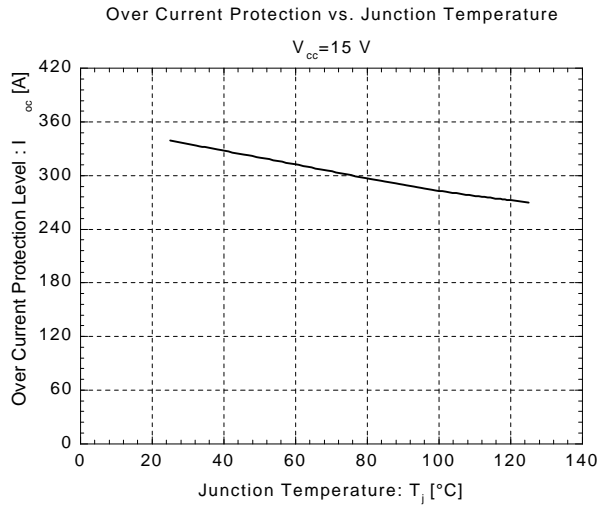

■ Outline Drawing

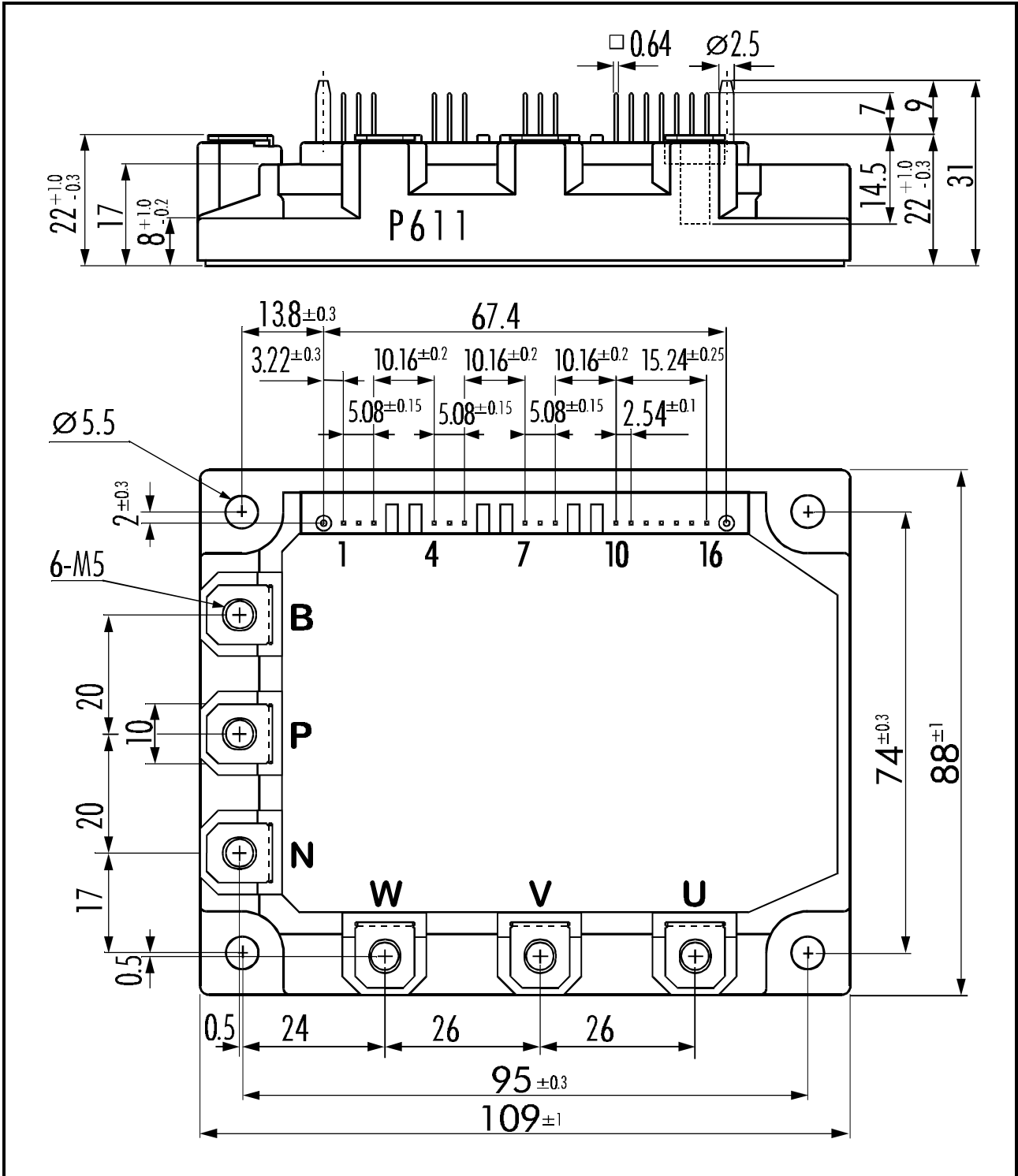

Weight: 440g