

## FEATURES

- Member of the Texas Instruments Widebus™ Family
- Operates From 1.65 V to 3.6 V
- Max  $t_{pd}$  of 3.6 ns at 3.3 V
- $\pm 24$ -mA Output Drive at 3.3 V
- Bus Hold on Data Inputs Eliminates the Need for External Pullup/Pulldown Resistors
- Latch-Up Performance Exceeds 250 mA Per JESD 17
- ESD Protection Exceeds JESD 22
  - 2000-V Human-Body Model (A114-A)
  - 200-V Machine Model (A115-A)

## DESCRIPTION/ORDERING INFORMATION

This 16-bit transparent D-type latch is designed for 1.65-V to 3.6-V  $V_{CC}$  operation.

The SN74ALVCH16373 is particularly suitable for implementing buffer registers, I/O ports, bidirectional bus drivers, and working registers. This device can be used as two 8-bit latches or one 16-bit latch. When the latch-enable (LE) input is high, the Q outputs follow the data (D) inputs. When LE is taken low, the Q outputs are latched at the levels set up at the D inputs.

A buffered output-enable ( $\overline{OE}$ ) input can be used to place the eight outputs in either a normal logic state (high or low logic levels) or the high-impedance state. In the high-impedance state, the outputs neither load nor drive the buslines significantly. The high-impedance state and the increased drive provide the capability to drive bus lines without need for interface or pullup components.  $\overline{OE}$  does not affect internal operations of the latch. Old data can be retained or new data can be entered while the outputs are in the high-impedance state.

To ensure the high-impedance state during power up or power down,  $\overline{OE}$  should be tied to  $V_{CC}$  through a pullup resistor; the minimum value of the resistor is determined by the current-sinking capability of the driver.

Active bus-hold circuitry holds unused or undriven inputs at a valid logic state. Use of pullup or pulldown resistors with the bus-hold circuitry is not recommended.

DGG OR DL PACKAGE  
(TOP VIEW)

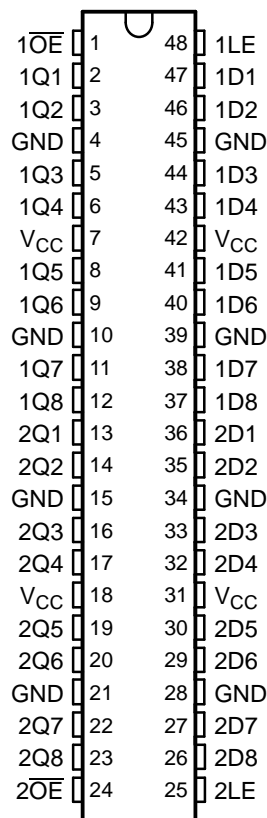

Please be aware that an important notice concerning availability, standard warranty, and use in critical applications of Texas Instruments semiconductor products and disclaimers thereto appears at the end of this data sheet.

Widebus is a trademark of Texas Instruments.

# SN74ALVCH16373 16-BIT TRANSPARENT D-TYPE LATCH WITH 3-STATE OUTPUTS

SCES020I–JULY 1995–REVISED NOVEMBER 2005

## ORDERING INFORMATION

T <sub>A</sub>	PACKAGE <sup>(1)</sup>		ORDERABLE PART NUMBER	TOP-SIDE MARKING
–40°C to 85°C	FBGA – GRD	Tape and reel	SN74ALVCH16373GRDR	VH373
	FBGA – ZRD (Pb-free)		SN74ALVCH16373ZRDR	
	SSOP – DL	Tube	SN74ALVCH16373DL	ALVCH16373
		Tape and reel	SN74ALVCH16373DLR	
			74ALVCH16373DLG4	
			74ALVCH16373DLRG4	
	TSSOP – DGG	Tape and reel	SN74ALVCH16373DGGR	ALVCH16373
			74ALVCH16373DGGE4	
			74ALVCH16373DGGRG4	
	VFBGA – GQL	Tape and reel	SN74ALVCH16373KR	VH373
VFBGA – ZQL (Pb-free)	74ALVCH16373ZQLR			

(1) Package drawings, standard packing quantities, thermal data, symbolization, and PCB design guidelines are available at [www.ti.com/sc/package](http://www.ti.com/sc/package).

### GQL OR ZQL PACKAGE (TOP VIEW)

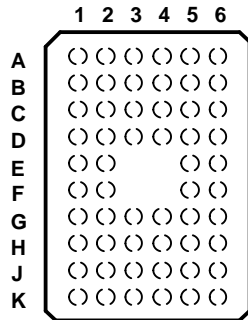

### TERMINAL ASSIGNMENTS<sup>(1)</sup> (56-Ball GQL/ZQL Package)

	1	2	3	4	5	6
A	1 $\overline{OE}$	NC	NC	NC	NC	1LE
B	1Q2	1Q1	GND	GND	1D1	1D2
C	1Q4	1Q3	V <sub>CC</sub>	V <sub>CC</sub>	1D3	1D4
D	1Q6	1Q5	GND	GND	1D5	1D6
E	1Q8	1Q7			1D7	1D8
F	2Q1	2Q2			2D2	2D1
G	2Q3	2Q4	GND	GND	2D4	2D3
H	2Q5	2Q6	V <sub>CC</sub>	V <sub>CC</sub>	2D6	2D5
J	2Q7	2Q8	GND	GND	2D8	2D7
K	2 $\overline{OE}$	NC	NC	NC	NC	2LE

(1) NC – No internal connection

### GRD OR ZRD PACKAGE (TOP VIEW)

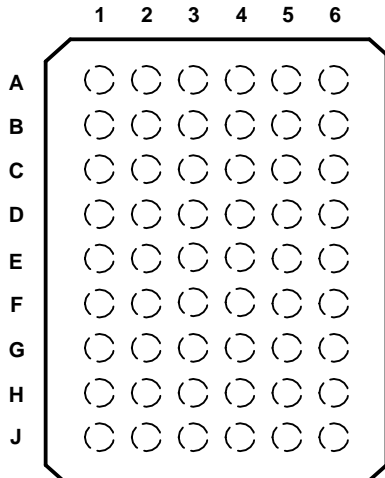

### TERMINAL ASSIGNMENTS<sup>(1)</sup> (54-Ball GRD/ZRD Package)

	1	2	3	4	5	6
A	1Q1	NC	1 $\overline{OE}$	1LE	NC	1D1
B	1Q3	1Q2	NC	NC	1D2	1D3
C	1Q5	1Q4	V <sub>CC</sub>	V <sub>CC</sub>	1D4	1D5
D	1Q7	1Q6	GND	GND	1D6	1D7
E	2Q1	1Q8	GND	GND	1D8	2D1
F	2Q3	2Q2	GND	GND	2D2	2D3
G	2Q5	2Q4	V <sub>CC</sub>	V <sub>CC</sub>	2D4	2D5
H	2Q7	2Q6	NC	NC	2D6	2D7
J	2Q8	NC	2 $\overline{OE}$	2LE	NC	2D8

(1) NC – No internal connection

**FUNCTION TABLE  
(EACH 8-BIT SECTION)**

INPUTS			OUTPUT Q
$\overline{OE}$	LE	D	
L	H	H	H
L	H	L	L
L	L	X	$Q_0$
H	X	X	Z

**LOGIC DIAGRAM (POSITIVE LOGIC)**

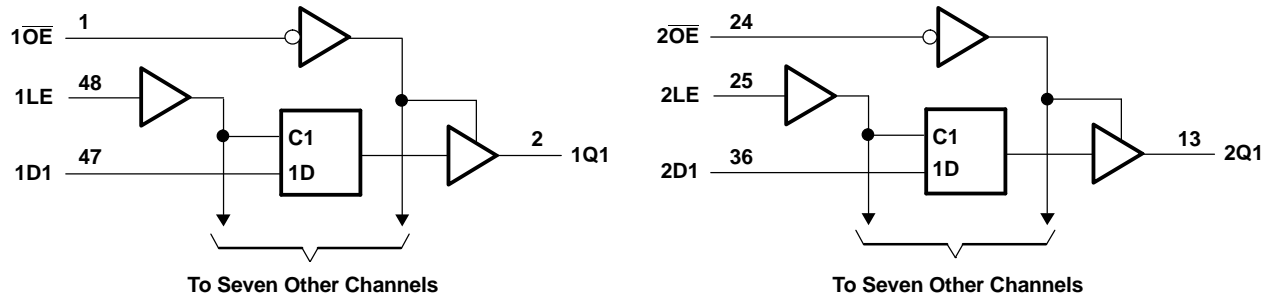

Pin numbers shown are for the DGG and DL packages.

### Absolute Maximum Ratings<sup>(1)</sup>

over operating free-air temperature range (unless otherwise noted)

		MIN	MAX	UNIT
$V_{CC}$	Supply voltage range	-0.5	4.6	V
$V_I$	Input voltage range <sup>(2)(3)</sup>	-0.5	$V_{CC} + 0.5$	V
$V_O$	Output voltage range <sup>(2)(3)</sup>	-0.5	$V_{CC} + 0.5$	V
$I_{IK}$	Input clamp current		-50	mA
$I_{OK}$	Output clamp current		-50	mA
$I_O$	Continuous output current		±50	mA
	Continuous current through each $V_{CC}$ or GND		±100	mA
$\theta_{JA}$	Package thermal impedance <sup>(4)</sup>	DGG package	70	°C/W
		DL package	63	
		GQL/ZQL package	42	
		GRD/ZRD package	36	
$T_{stg}$	Storage temperature range	-65	150	°C

- (1) Stresses beyond those listed under "absolute maximum ratings" may cause permanent damage to the device. These are stress ratings only, and functional operation of the device at these or any other conditions beyond those indicated under "recommended operating conditions" is not implied. Exposure to absolute-maximum-rated conditions for extended periods may affect device reliability.
- (2) The input negative-voltage and output voltage ratings may be exceeded if the input and output current ratings are observed.
- (3) This value is limited to 4.6 V maximum.
- (4) The package thermal impedance is calculated in accordance with JESD 51-7.

**SN74ALVCH16373**  
**16-BIT TRANSPARENT D-TYPE LATCH**  
**WITH 3-STATE OUTPUTS**

SCES020I–JULY 1995–REVISED NOVEMBER 2005

**Recommended Operating Conditions<sup>(1)</sup>**

		MIN	MAX	UNIT
V <sub>CC</sub>	Supply voltage	1.65	3.6	V
V <sub>IH</sub>	High-level input voltage	V <sub>CC</sub> = 1.65 V to 1.95 V	0.65 × V <sub>CC</sub>	V
		V <sub>CC</sub> = 2.3 V to 2.7 V	1.7	
		V <sub>CC</sub> = 2.7 V to 3.6 V	2	
V <sub>IL</sub>	Low-level input voltage	V <sub>CC</sub> = 1.65 V to 1.95 V	0.35 × V <sub>CC</sub>	V
		V <sub>CC</sub> = 2.3 V to 2.7 V	0.7	
		V <sub>CC</sub> = 2.7 V to 3.6 V	0.8	
V <sub>I</sub>	Input voltage	0	V <sub>CC</sub>	V
V <sub>O</sub>	Output voltage	0	V <sub>CC</sub>	V
I <sub>OH</sub>	High-level output current	V <sub>CC</sub> = 1.65 V	–4	mA
		V <sub>CC</sub> = 2.3 V	–12	
		V <sub>CC</sub> = 2.7 V	–12	
		V <sub>CC</sub> = 3 V	–24	
I <sub>OL</sub>	Low-level output current	V <sub>CC</sub> = 1.65 V	4	mA
		V <sub>CC</sub> = 2.3 V	12	
		V <sub>CC</sub> = 2.7 V	12	
		V <sub>CC</sub> = 3 V	24	
Δt/Δv	Input transition rise or fall rate		10	ns/V
T <sub>A</sub>	Operating free-air temperature	–40	85	°C

(1) All unused control inputs of the device must be held at V<sub>CC</sub> or GND to ensure proper device operation. Refer to the TI application report, *Implications of Slow or Floating CMOS Inputs*, literature number SCBA004.

## Electrical Characteristics

over recommended operating free-air temperature range (unless otherwise noted)

PARAMETER		TEST CONDITIONS	V <sub>CC</sub>	MIN	TYP <sup>(1)</sup>	MAX	UNIT
V <sub>OH</sub>		I <sub>OH</sub> = -100 μA	1.65 V to 3.6 V	V <sub>CC</sub> - 0.2			V
		I <sub>OH</sub> = -4 mA	1.65 V	1.2			
		I <sub>OH</sub> = -6 mA	2.3 V	2			
		I <sub>OH</sub> = -12 mA	2.3 V	1.7			
			2.7 V	2.2			
			3 V	2.4			
	I <sub>OH</sub> = -24 mA	3 V	2				
V <sub>OL</sub>		I <sub>OL</sub> = 100 μA	1.65 V to 3.6 V			0.2	V
		I <sub>OL</sub> = 4 mA	1.65 V			0.45	
		I <sub>OL</sub> = 6 mA	2.3 V			0.4	
		I <sub>OL</sub> = 12 mA	2.3 V			0.7	
			2.7 V			0.4	
		I <sub>OL</sub> = 24 mA	3 V			0.55	
I <sub>I</sub>		V <sub>I</sub> = V <sub>CC</sub> or GND	3.6 V			±5	μA
I <sub>I(hold)</sub>		V <sub>I</sub> = 0.58 V	1.65 V	25			μA
		V <sub>I</sub> = 1.07 V	1.65 V	-25			
		V <sub>I</sub> = 0.7 V	2.3 V	45			
		V <sub>I</sub> = 1.7 V	2.3 V	-45			
		V <sub>I</sub> = 0.8 V	3 V	75			
		V <sub>I</sub> = 2 V	3 V	-75			
		V <sub>I</sub> = 0 to 3.6 V <sup>(2)</sup>	3.6 V			±500	
I <sub>OZ</sub>		V <sub>O</sub> = V <sub>CC</sub> or GND	3.6 V			±10	μA
I <sub>CC</sub>		V <sub>I</sub> = V <sub>CC</sub> or GND      I <sub>O</sub> = 0	3.6 V			40	μA
ΔI <sub>CC</sub>		One input at V <sub>CC</sub> - 0.6 V,    Other inputs at V <sub>CC</sub> or GND	3 V to 3.6 V			750	μA
C <sub>i</sub>	Control inputs	V <sub>I</sub> = V <sub>CC</sub> or GND	3.3 V	3		pF	
	Data inputs			6			
C <sub>o</sub>	Outputs	V <sub>O</sub> = V <sub>CC</sub> or GND	3.3 V	7		pF	

(1) All typical values are at V<sub>CC</sub> = 3.3 V, T<sub>A</sub> = 25°C.

(2) This is the bus-hold maximum dynamic current. It is the minimum overdrive current required to switch the input from one state to another.

## Timing Requirements

over recommended operating free-air temperature range (unless otherwise noted) (see Figure 1)

		V <sub>CC</sub> = 1.8 V		V <sub>CC</sub> = 2.5 V ± 0.2 V		V <sub>CC</sub> = 2.7 V		V <sub>CC</sub> = 3.3 V ± 0.3 V		UNIT
		MIN	MAX	MIN	MAX	MIN	MAX	MIN	MAX	
t <sub>w</sub>	Pulse duration, LE high or low	(1)		3.3		3.3		3.3		ns
t <sub>su</sub>	Setup time, data before LE↓	(1)		1		1		1.1		ns
t <sub>h</sub>	Hold time, data after LE↓	(1)		1.5		1.7		1.4		ns

(1) This information was not available at the time of publication.

**SN74ALVCH16373**  
**16-BIT TRANSPARENT D-TYPE LATCH**  
**WITH 3-STATE OUTPUTS**

SCES020I–JULY 1995–REVISED NOVEMBER 2005

**Switching Characteristics**

over recommended operating free-air temperature range (unless otherwise noted) (see Figure 1)

PARAMETER	FROM (INPUT)	TO (OUTPUT)	V <sub>CC</sub> = 1.8 V	V <sub>CC</sub> = 2.5 V ± 0.2 V		V <sub>CC</sub> = 2.7 V		V <sub>CC</sub> = 3.3 V ± 0.3 V		UNIT
			TYP	MIN	MAX	MIN	MAX	MIN	MAX	
t <sub>pd</sub>	D	Q	(1)	1	4.5	4.3		1.1	3.6	ns
	LE		(1)	1	4.9	4.6		1	3.9	
t <sub>en</sub>	$\overline{OE}$	Q	(1)	1	6	5.7		1	4.7	ns
t <sub>dis</sub>	$\overline{OE}$	Q	(1)	1.2	5.1	4.5		1.4	4.1	ns

(1) This information was not available at the time of publication.

**Operating Characteristics**

T<sub>A</sub> = 25°C

PARAMETER		TEST CONDITIONS	V <sub>CC</sub> = 1.8 V	V <sub>CC</sub> = 2.5 V	V <sub>CC</sub> = 3.3 V	UNIT
			TYP	TYP	TYP	
C <sub>pd</sub>	Power dissipation capacitance	C <sub>L</sub> = 50 pF, f = 10 MHz	(1)	19	22	pF
	Outputs disabled		(1)	4	5	

(1) This information was not available at the time of publication.

PARAMETER MEASUREMENT INFORMATION

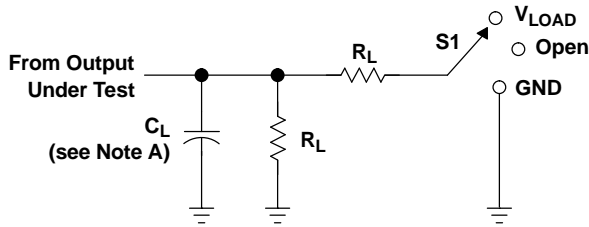

TEST	S1
$t_{pd}$	Open
$t_{PLZ}/t_{PZL}$	$V_{LOAD}$
$t_{PHZ}/t_{PZH}$	GND

LOAD CIRCUIT

$V_{CC}$	INPUT		$V_M$	$V_{LOAD}$	$C_L$	$R_L$	$V_{\Delta}$
	$V_I$	$t_r/t_f$					
1.8 V	$V_{CC}$	$\leq 2$ ns	$V_{CC}/2$	$2 \times V_{CC}$	30 pF	1 k $\Omega$	0.15 V
$2.5 V \pm 0.2 V$	$V_{CC}$	$\leq 2$ ns	$V_{CC}/2$	$2 \times V_{CC}$	30 pF	500 $\Omega$	0.15 V
2.7 V	2.7 V	$\leq 2.5$ ns	1.5 V	6 V	50 pF	500 $\Omega$	0.3 V
$3.3 V \pm 0.3 V$	2.7 V	$\leq 2.5$ ns	1.5 V	6 V	50 pF	500 $\Omega$	0.3 V

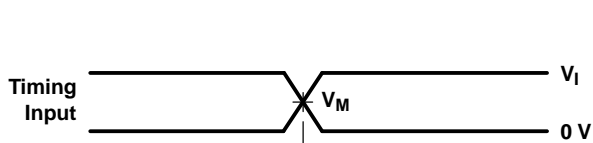

VOLTAGE WAVEFORMS  
SETUP AND HOLD TIMES

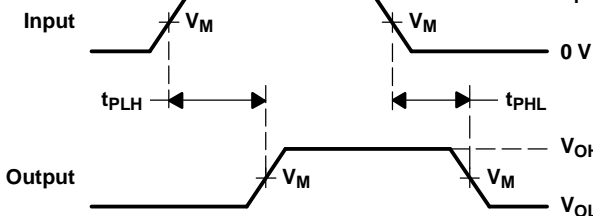

VOLTAGE WAVEFORMS  
PROPAGATION DELAY TIMES

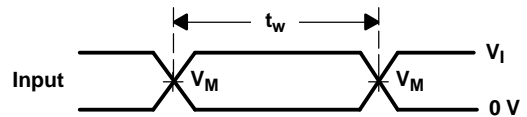

VOLTAGE WAVEFORMS  
PULSE DURATION

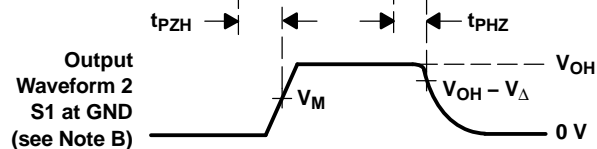
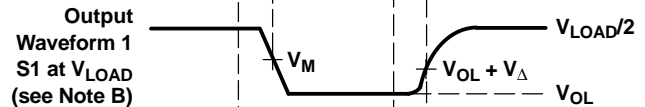
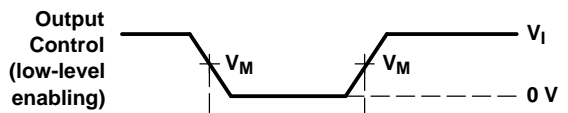

VOLTAGE WAVEFORMS  
ENABLE AND DISABLE TIMES

- NOTES: A.  $C_L$  includes probe and jig capacitance.  
 B. Waveform 1 is for an output with internal conditions such that the output is low, except when disabled by the output control. Waveform 2 is for an output with internal conditions such that the output is high, except when disabled by the output control.  
 C. All input pulses are supplied by generators having the following characteristics:  $PRR \leq 10$  MHz,  $Z_O = 50 \Omega$ .  
 D. The outputs are measured one at a time, with one transition per measurement.  
 E.  $t_{PLZ}$  and  $t_{PHZ}$  are the same as  $t_{dis}$ .  
 F.  $t_{PZL}$  and  $t_{PZH}$  are the same as  $t_{en}$ .  
 G.  $t_{PLH}$  and  $t_{PHL}$  are the same as  $t_{pd}$ .  
 H. All parameters and waveforms are not applicable to all devices.

Figure 1. Load Circuit and Voltage Waveforms

**PACKAGING INFORMATION**

Orderable Device	Status (1)	Package Type	Package Drawing	Pins	Package Qty	Eco Plan (2)	Lead/Ball Finish (6)	MSL Peak Temp (3)	Op Temp (°C)	Device Marking (4/5)	Samples
74ALVCH16373DGGRG4	ACTIVE	TSSOP	DGG	48	2000	Green (RoHS & no Sb/Br)	CU NIPDAU	Level-1-260C-UNLIM	-40 to 85	ALVCH16373	<a href="#">Samples</a>
74ALVCH16373DLRG4	ACTIVE	SSOP	DL	48	1000	Green (RoHS & no Sb/Br)	CU NIPDAU	Level-1-260C-UNLIM	-40 to 85	ALVCH16373	<a href="#">Samples</a>
74ALVCH16373GRDR	OBSOLETE	BGA MICROSTAR JUNIOR	GRD	54		TBD	Call TI	Call TI	-40 to 85		
74ALVCH16373ZQLR	ACTIVE	BGA MICROSTAR JUNIOR	ZQL	56	1000	Green (RoHS & no Sb/Br)	SNAGCU	Level-1-260C-UNLIM	-40 to 85	VH373	<a href="#">Samples</a>
74ALVCH16373ZRDR	ACTIVE	BGA MICROSTAR JUNIOR	ZRD	54	1000	Green (RoHS & no Sb/Br)	SNAGCU	Level-1-260C-UNLIM	-40 to 85	VH373	<a href="#">Samples</a>
SN74ALVCH16373DGGR	ACTIVE	TSSOP	DGG	48	2000	Green (RoHS & no Sb/Br)	CU NIPDAU	Level-1-260C-UNLIM	-40 to 85	ALVCH16373	<a href="#">Samples</a>
SN74ALVCH16373DL	ACTIVE	SSOP	DL	48	25	Green (RoHS & no Sb/Br)	CU NIPDAU	Level-1-260C-UNLIM	-40 to 85	ALVCH16373	<a href="#">Samples</a>
SN74ALVCH16373DLR	ACTIVE	SSOP	DL	48	1000	Green (RoHS & no Sb/Br)	CU NIPDAU	Level-1-260C-UNLIM	-40 to 85	ALVCH16373	<a href="#">Samples</a>
SN74ALVCH16373KR	OBSOLETE	BGA MICROSTAR JUNIOR	GQL	56		TBD	Call TI	Call TI	-40 to 85		

(1) The marketing status values are defined as follows:

**ACTIVE:** Product device recommended for new designs.

**LIFEBUY:** TI has announced that the device will be discontinued, and a lifetime-buy period is in effect.

**NRND:** Not recommended for new designs. Device is in production to support existing customers, but TI does not recommend using this part in a new design.

**PREVIEW:** Device has been announced but is not in production. Samples may or may not be available.

**OBSOLETE:** TI has discontinued the production of the device.

(2) Eco Plan - The planned eco-friendly classification: Pb-Free (RoHS), Pb-Free (RoHS Exempt), or Green (RoHS & no Sb/Br) - please check <http://www.ti.com/productcontent> for the latest availability information and additional product content details.

**TBD:** The Pb-Free/Green conversion plan has not been defined.

**Pb-Free (RoHS):** TI's terms "Lead-Free" or "Pb-Free" mean semiconductor products that are compatible with the current RoHS requirements for all 6 substances, including the requirement that lead not exceed 0.1% by weight in homogeneous materials. Where designed to be soldered at high temperatures, TI Pb-Free products are suitable for use in specified lead-free processes.

**Pb-Free (RoHS Exempt):** This component has a RoHS exemption for either 1) lead-based flip-chip solder bumps used between the die and package, or 2) lead-based die adhesive used between the die and leadframe. The component is otherwise considered Pb-Free (RoHS compatible) as defined above.



---

**Green (RoHS & no Sb/Br):** TI defines "Green" to mean Pb-Free (RoHS compatible), and free of Bromine (Br) and Antimony (Sb) based flame retardants (Br or Sb do not exceed 0.1% by weight in homogeneous material)

(3) MSL, Peak Temp. - The Moisture Sensitivity Level rating according to the JEDEC industry standard classifications, and peak solder temperature.

(4) There may be additional marking, which relates to the logo, the lot trace code information, or the environmental category on the device.

(5) Multiple Device Markings will be inside parentheses. Only one Device Marking contained in parentheses and separated by a "~" will appear on a device. If a line is indented then it is a continuation of the previous line and the two combined represent the entire Device Marking for that device.

(6) Lead/Ball Finish - Orderable Devices may have multiple material finish options. Finish options are separated by a vertical ruled line. Lead/Ball Finish values may wrap to two lines if the finish value exceeds the maximum column width.

**Important Information and Disclaimer:** The information provided on this page represents TI's knowledge and belief as of the date that it is provided. TI bases its knowledge and belief on information provided by third parties, and makes no representation or warranty as to the accuracy of such information. Efforts are underway to better integrate information from third parties. TI has taken and continues to take reasonable steps to provide representative and accurate information but may not have conducted destructive testing or chemical analysis on incoming materials and chemicals. TI and TI suppliers consider certain information to be proprietary, and thus CAS numbers and other limited information may not be available for release.

In no event shall TI's liability arising out of such information exceed the total purchase price of the TI part(s) at issue in this document sold by TI to Customer on an annual basis.

**TAPE AND REEL INFORMATION**

**QUADRANT ASSIGNMENTS FOR PIN 1 ORIENTATION IN TAPE**

\*All dimensions are nominal

Device	Package Type	Package Drawing	Pins	SPQ	Reel Diameter (mm)	Reel Width W1 (mm)	A0 (mm)	B0 (mm)	K0 (mm)	P1 (mm)	W (mm)	Pin1 Quadrant
74ALVCH16373ZQLR	BGA MICROSTAR JUNIOR	ZQL	56	1000	330.0	16.4	4.8	7.3	1.5	8.0	16.0	Q1
74ALVCH16373ZRDR	BGA MICROSTAR JUNIOR	ZRD	54	1000	330.0	16.4	5.8	8.3	1.55	8.0	16.0	Q1
SN74ALVCH16373DGGR	TSSOP	DGG	48	2000	330.0	24.4	8.6	15.8	1.8	12.0	24.0	Q1
SN74ALVCH16373DLR	SSOP	DL	48	1000	330.0	32.4	11.35	16.2	3.1	16.0	32.0	Q1

**TAPE AND REEL BOX DIMENSIONS**

\*All dimensions are nominal

Device	Package Type	Package Drawing	Pins	SPQ	Length (mm)	Width (mm)	Height (mm)
74ALVCH16373ZQLR	BGA MICROSTAR JUNIOR	ZQL	56	1000	333.2	345.9	28.6
74ALVCH16373ZRDR	BGA MICROSTAR JUNIOR	ZRD	54	1000	333.2	345.9	28.6
SN74ALVCH16373DGGR	TSSOP	DGG	48	2000	367.0	367.0	45.0
SN74ALVCH16373DLR	SSOP	DL	48	1000	367.0	367.0	55.0

ZQL (R-PBGA-N56)

PLASTIC BALL GRID ARRAY

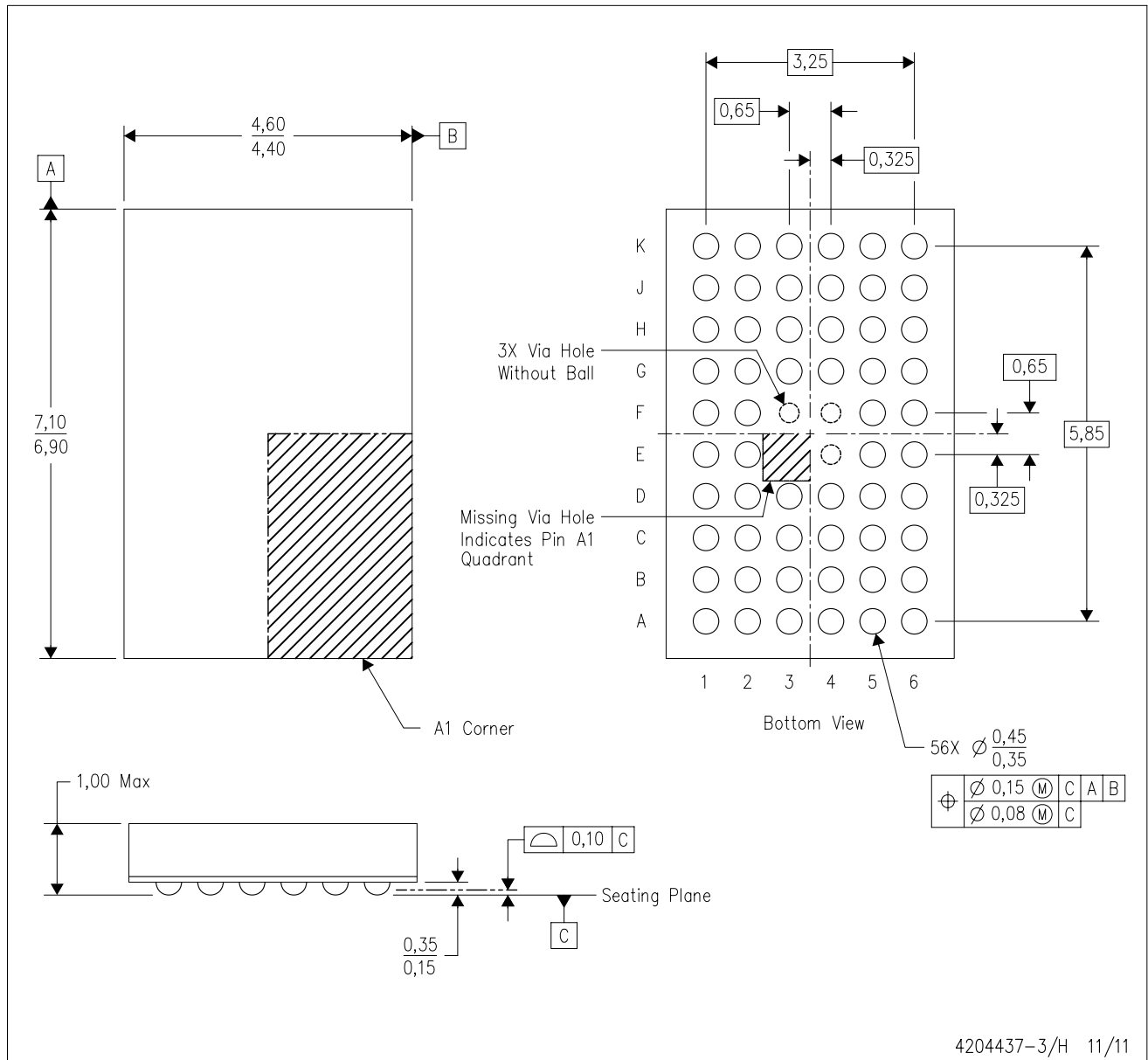

- NOTES:
- A. All linear dimensions are in millimeters. Dimensioning and tolerancing per ASME Y14.5M-1994.
  - B. This drawing is subject to change without notice.
  - C. Falls within JEDEC MO-285 variation BA-2.
  - D. This package is Pb-free. Refer to the 56 GQL package (drawing 4200583) for tin-lead (SnPb).

GRD (R-PBGA-N54)

PLASTIC BALL GRID ARRAY

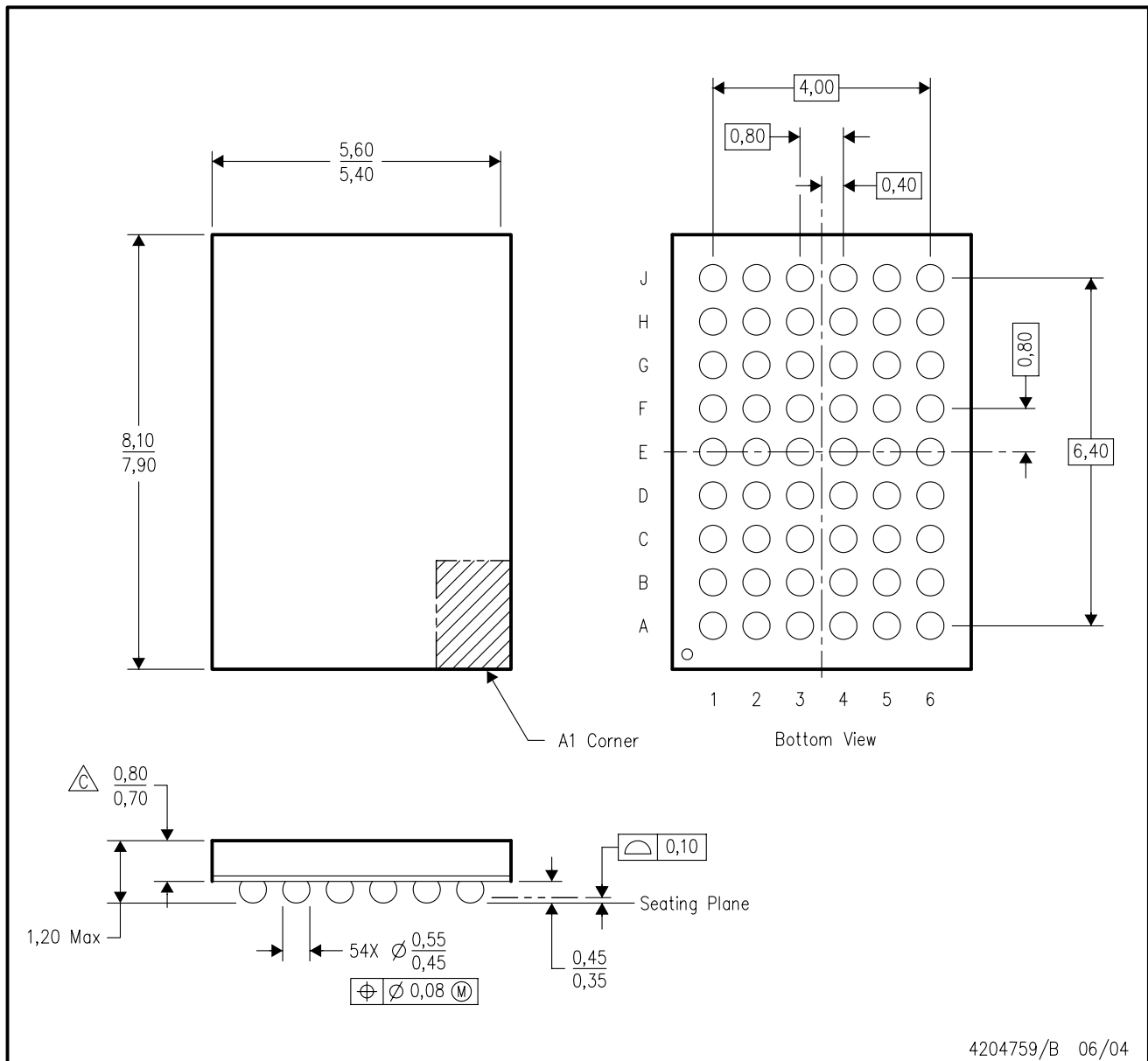

- NOTES:
- A. All linear dimensions are in millimeters.
  - B. This drawing is subject to change without notice.
  - C Falls within JEDEC MO-205 variation DD.
  - D. This package is tin-lead (SnPb). Refer to the 54 ZRD package (drawing 4204760) for lead-free.

ZRD (R-PBGA-N54)

PLASTIC BALL GRID ARRAY



- NOTES:
- A. All linear dimensions are in millimeters.
  - B. This drawing is subject to change without notice.
  - $\triangle$  Falls within JEDEC MO-205 variation DD.
  - D. This package is lead-free. Refer to the 54 GRD package (drawing 4204759) for tin-lead (SnPb).

# MECHANICAL DATA

DL (R-PDSO-G48)

PLASTIC SMALL-OUTLINE PACKAGE

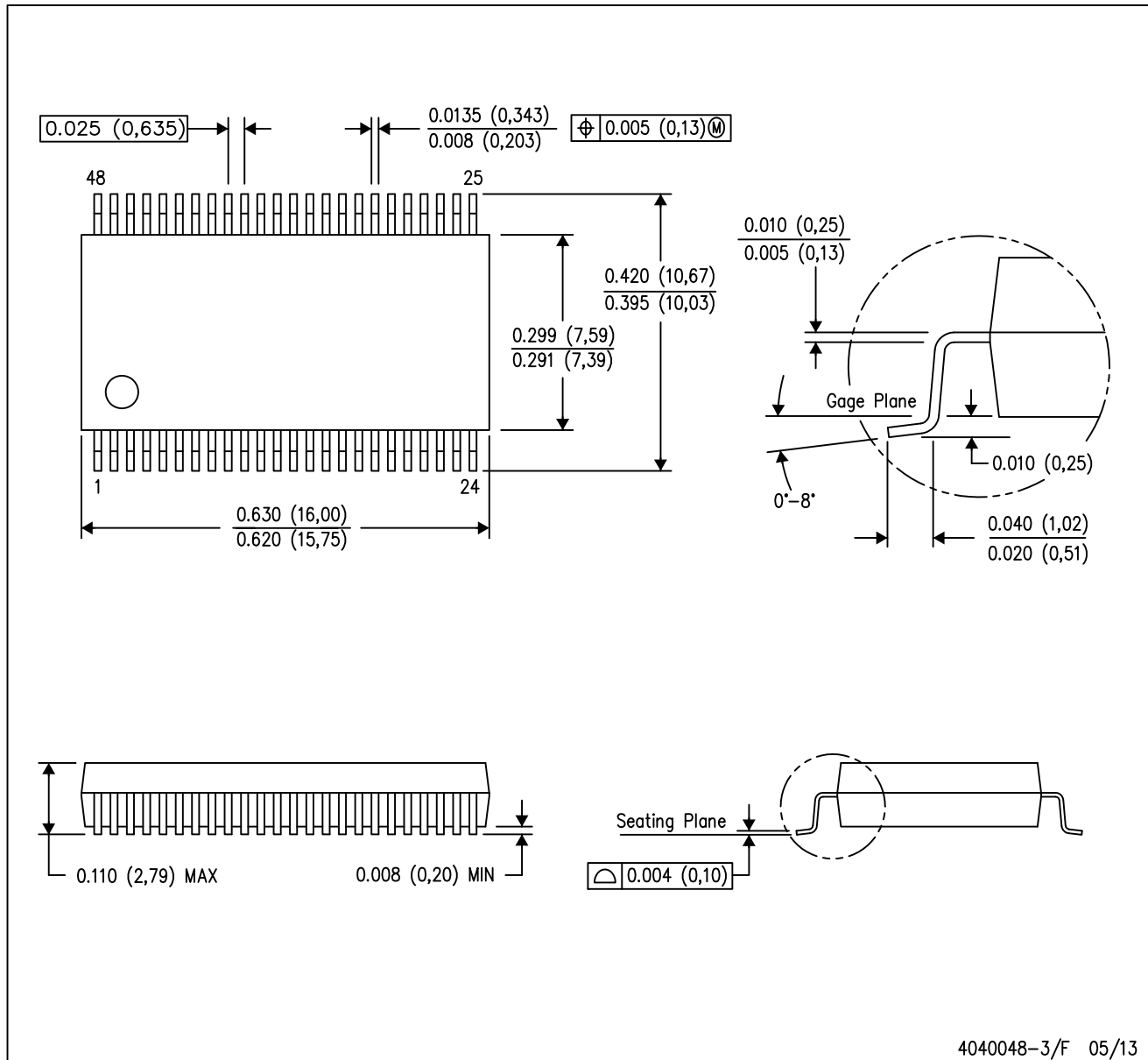

- NOTES:
- All linear dimensions are in inches (millimeters).
  - This drawing is subject to change without notice.
  - Body dimensions do not include mold flash or protrusion not to exceed 0.006 (0,15).
  - Falls within JEDEC MO-118

PowerPAD is a trademark of Texas Instruments.

GQL (R-PBGA-N56)

PLASTIC BALL GRID ARRAY

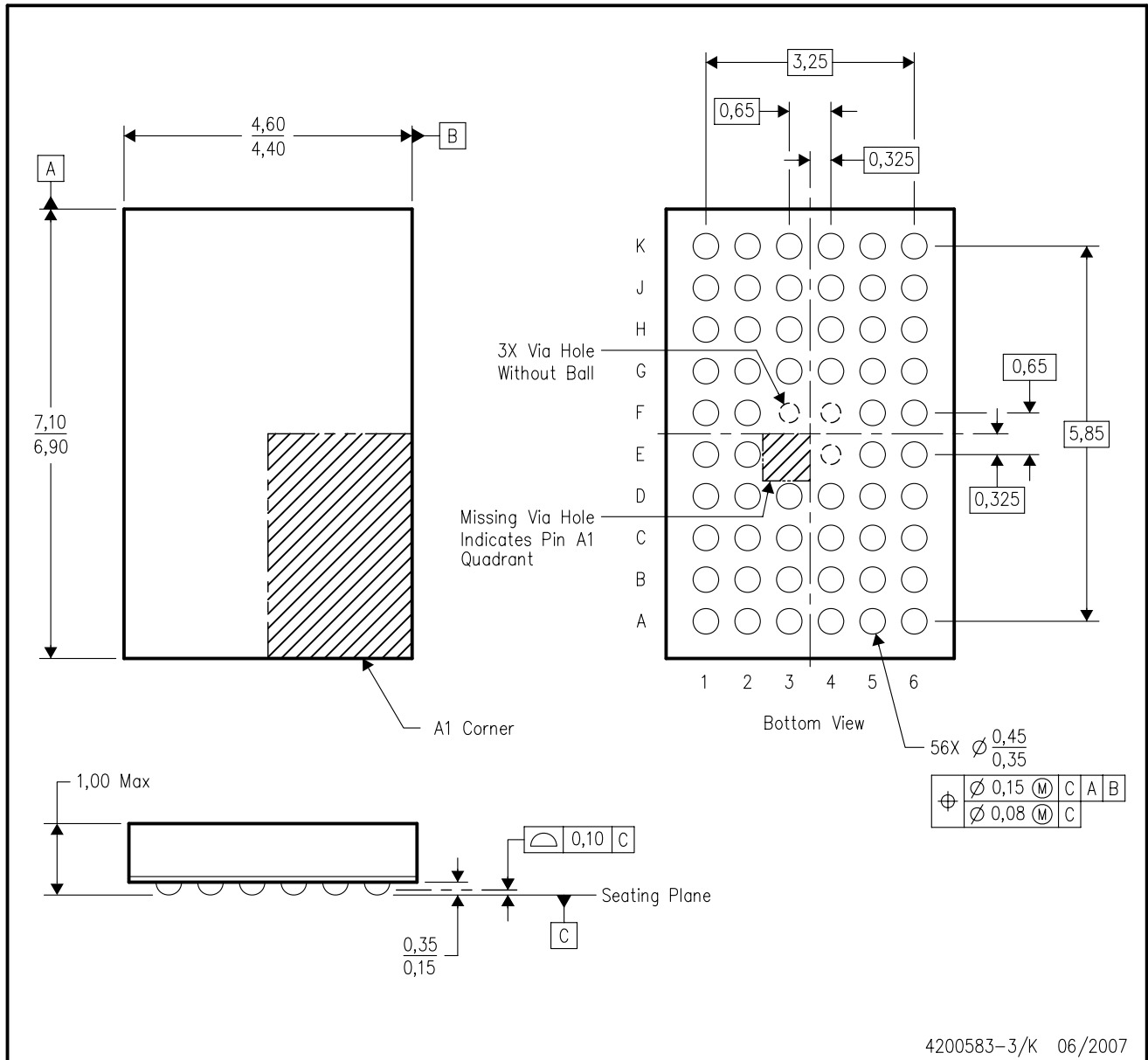

- NOTES:
- All linear dimensions are in millimeters. Dimensioning and tolerancing per ASME Y14.5M-1994.
  - This drawing is subject to change without notice.
  - Falls within JEDEC MO-285 variation BA-2.
  - This package is tin-lead (SnPb). Refer to the 56 ZQL package (drawing 4204437) for lead-free.



DGG (R-PDSO-G\*\*)

PLASTIC SMALL-OUTLINE PACKAGE

48 PINS SHOWN



- NOTES: A. All linear dimensions are in millimeters.  
 B. This drawing is subject to change without notice.  
 C. Body dimensions do not include mold protrusion not to exceed 0,15.  
 D. Falls within JEDEC MO-153

## IMPORTANT NOTICE

Texas Instruments Incorporated and its subsidiaries (TI) reserve the right to make corrections, enhancements, improvements and other changes to its semiconductor products and services per JESD46, latest issue, and to discontinue any product or service per JESD48, latest issue. Buyers should obtain the latest relevant information before placing orders and should verify that such information is current and complete. All semiconductor products (also referred to herein as "components") are sold subject to TI's terms and conditions of sale supplied at the time of order acknowledgment.

TI warrants performance of its components to the specifications applicable at the time of sale, in accordance with the warranty in TI's terms and conditions of sale of semiconductor products. Testing and other quality control techniques are used to the extent TI deems necessary to support this warranty. Except where mandated by applicable law, testing of all parameters of each component is not necessarily performed.

TI assumes no liability for applications assistance or the design of Buyers' products. Buyers are responsible for their products and applications using TI components. To minimize the risks associated with Buyers' products and applications, Buyers should provide adequate design and operating safeguards.

TI does not warrant or represent that any license, either express or implied, is granted under any patent right, copyright, mask work right, or other intellectual property right relating to any combination, machine, or process in which TI components or services are used. Information published by TI regarding third-party products or services does not constitute a license to use such products or services or a warranty or endorsement thereof. Use of such information may require a license from a third party under the patents or other intellectual property of the third party, or a license from TI under the patents or other intellectual property of TI.

Reproduction of significant portions of TI information in TI data books or data sheets is permissible only if reproduction is without alteration and is accompanied by all associated warranties, conditions, limitations, and notices. TI is not responsible or liable for such altered documentation. Information of third parties may be subject to additional restrictions.

Resale of TI components or services with statements different from or beyond the parameters stated by TI for that component or service voids all express and any implied warranties for the associated TI component or service and is an unfair and deceptive business practice. TI is not responsible or liable for any such statements.

Buyer acknowledges and agrees that it is solely responsible for compliance with all legal, regulatory and safety-related requirements concerning its products, and any use of TI components in its applications, notwithstanding any applications-related information or support that may be provided by TI. Buyer represents and agrees that it has all the necessary expertise to create and implement safeguards which anticipate dangerous consequences of failures, monitor failures and their consequences, lessen the likelihood of failures that might cause harm and take appropriate remedial actions. Buyer will fully indemnify TI and its representatives against any damages arising out of the use of any TI components in safety-critical applications.

In some cases, TI components may be promoted specifically to facilitate safety-related applications. With such components, TI's goal is to help enable customers to design and create their own end-product solutions that meet applicable functional safety standards and requirements. Nonetheless, such components are subject to these terms.

No TI components are authorized for use in FDA Class III (or similar life-critical medical equipment) unless authorized officers of the parties have executed a special agreement specifically governing such use.

Only those TI components which TI has specifically designated as military grade or "enhanced plastic" are designed and intended for use in military/aerospace applications or environments. Buyer acknowledges and agrees that any military or aerospace use of TI components which have **not** been so designated is solely at the Buyer's risk, and that Buyer is solely responsible for compliance with all legal and regulatory requirements in connection with such use.

TI has specifically designated certain components as meeting ISO/TS16949 requirements, mainly for automotive use. In any case of use of non-designated products, TI will not be responsible for any failure to meet ISO/TS16949.

### Products

Audio	<a href="http://www.ti.com/audio">www.ti.com/audio</a>
Amplifiers	<a href="http://amplifier.ti.com">amplifier.ti.com</a>
Data Converters	<a href="http://dataconverter.ti.com">dataconverter.ti.com</a>
DLP® Products	<a href="http://www.dlp.com">www.dlp.com</a>
DSP	<a href="http://dsp.ti.com">dsp.ti.com</a>
Clocks and Timers	<a href="http://www.ti.com/clocks">www.ti.com/clocks</a>
Interface	<a href="http://interface.ti.com">interface.ti.com</a>
Logic	<a href="http://logic.ti.com">logic.ti.com</a>
Power Mgmt	<a href="http://power.ti.com">power.ti.com</a>
Microcontrollers	<a href="http://microcontroller.ti.com">microcontroller.ti.com</a>
RFID	<a href="http://www.ti-rfid.com">www.ti-rfid.com</a>
OMAP Applications Processors	<a href="http://www.ti.com/omap">www.ti.com/omap</a>
Wireless Connectivity	<a href="http://www.ti.com/wirelessconnectivity">www.ti.com/wirelessconnectivity</a>

### Applications

Automotive and Transportation	<a href="http://www.ti.com/automotive">www.ti.com/automotive</a>
Communications and Telecom	<a href="http://www.ti.com/communications">www.ti.com/communications</a>
Computers and Peripherals	<a href="http://www.ti.com/computers">www.ti.com/computers</a>
Consumer Electronics	<a href="http://www.ti.com/consumer-apps">www.ti.com/consumer-apps</a>
Energy and Lighting	<a href="http://www.ti.com/energy">www.ti.com/energy</a>
Industrial	<a href="http://www.ti.com/industrial">www.ti.com/industrial</a>
Medical	<a href="http://www.ti.com/medical">www.ti.com/medical</a>
Security	<a href="http://www.ti.com/security">www.ti.com/security</a>
Space, Avionics and Defense	<a href="http://www.ti.com/space-avionics-defense">www.ti.com/space-avionics-defense</a>
Video and Imaging	<a href="http://www.ti.com/video">www.ti.com/video</a>

### TI E2E Community

[e2e.ti.com](http://e2e.ti.com)