

PLEASE CHECK WWW.MOLEX.COM FOR LATEST PART INFORMATION

Part Number: [52991-0208](#)
Status: **Active**
Overview: SlimStack™ 0.50mm Pitch
Description: 0.50mm Pitch SlimStack™ Receptacle, Surface Mount, Dual Row, Vertical, 3.00 and 4.00mm Stacking Heights, Lower Circuit Size Version, White, 20 Circuits

Documents:

3D Model	Product Specification PS-54167-002 (PDF)
Drawing (PDF)	Packaging Specification SPK-52991-001 (PDF)
Product Specification PS-52991-003 (PDF)	RoHS Certificate of Compliance (PDF)

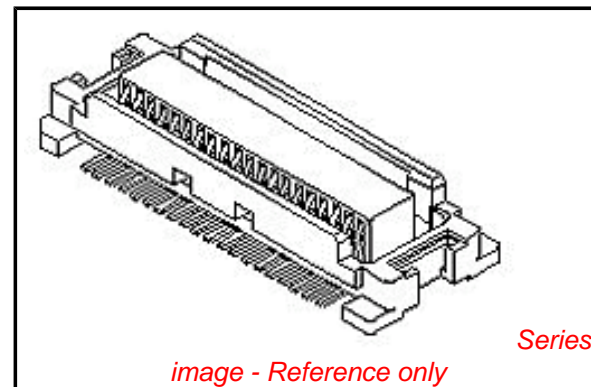

General

Product Family	PCB Receptacles
Series	52991
Application	Board-to-Board, Signal
Overview	SlimStack™ 0.50mm Pitch
Product Name	SlimStack™
UPC	800753749825

Physical

Circuits (Loaded)	20
Circuits (maximum)	20
Glow-Wire Compliant	No
Mated Height	3.00mm, 4.00mm
Material - Plating Mating	Gold
Material - Plating Termination	Gold
Net Weight	93.801/mg
Number of Rows	2
Orientation	Vertical
PCB Locator	No
PCB Retention	None
PCB Thickness - Recommended	1.60mm
Packaging Type	Embossed Tape on Reel
Pitch - Mating Interface	0.50mm
Plating min - Mating	0.102µm
Plating min - Termination	0.254µm
Polarized to PCB	No
Surface Mount Compatible (SMC)	N/A
Temperature Range - Operating	-40°C to +105°C
Termination Interface: Style	Surface Mount

Electrical

Current - Maximum per Contact	0.5A
Voltage - Maximum	50V

Material Info

Reference - Drawing Numbers

Packaging Specification	SPK-52991-001
Product Specification	PS-52991-003, PS-54167-002, RPS-52991-009, RPS-52991-012, RPS-52991-013, RPS-52991-014, RPS-52991-016, RPS-52991-017, RPS-52991-019, RPS-54167-009
Sales Drawing	SD-52991-004, SD-52991-005

EU RoHS ELV and RoHS Compliant REACH SVHC Contains SVHC: No Low-Halogen Status Low-Halogen	China RoHS 
---	--

Need more information on product environmental compliance?

Email productcompliance@molex.com
For a multiple part number RoHS Certificate of Compliance, [click here](#)

Please visit the [Contact Us](#) section for any non-product compliance questions.

Search Parts in this Series

[52991Series](#)

Mates With

Board-to-Board SlimStack™ Plug [53748](#) ,
[53916](#) , [501920](#)

This document was generated on 06/05/2013

PLEASE CHECK WWW.MOLEX.COM FOR LATEST PART INFORMATION