

Features

- Surface mount 2 mm Square / Single-turn / Cermet / Sealed
- Compatible with surface mount manufacturing processes
- Miniature design for flexibility
- RoHS compliant*
- For trimmer applications/processing guidelines, [click here](#)

3312 - 2 mm SMD Trimpot® Trimming Potentiometer

Electrical Characteristics

Standard Resistance Range 10 ohms to 2 megohms
 (see standard resistance table)
 Resistance Tolerance ±20 % std.
 End Resistance 1 % or 2 ohms max.
 (whichever is greater)
 Contact Resistance Variation 5 % or 3 ohms max.
 (whichever is greater)
 Adjustability
 Voltage Divider ±0.4 %
 Rheostat ±0.8 %
 Resolution Essentially infinite
 Insulation Resistance 500 VDC
 100 megohms min.
 Dielectric Strength
 Sea Level 500 VAC
 70,000 Feet 350 VAC
 Adjustment Angle 255 ° nom.

Environmental Characteristics

Power Rating (50 volts max.)
 70 °C 0.1 watt
 125 °C 0 watt
 Operating Temperature Range -55 °C to +125 °C
 Temperature Coefficient ±100 ppm/°C
 Humidity MIL-STD-202 Method 106
 TRS ±5 %; IR 10 megohms
 Vibration 20 G TRS ±1 %; VRS ±1 %
 Shock 100 G TRS ±1 %; VRS ±1 %
 Load Life @ 70 °C Rated Power TRS ±3 %
 Rotational Life 25 cycles TRS ±3 %
 Thermal Shock 5 cycles
 TRS ±2 %; VRS ±4 %

Physical Characteristics

Mechanical Stop 285 ° nom.
 Torque 0.7 oz-in. max
 Stop Strength 0.7 oz-in. nom.
 Weight Approximately 0.0321 g
 Marking Resistance code and date code
 Standard Packaging 500 pcs./7 " reel
 (MSL-1)

Product Dimensions

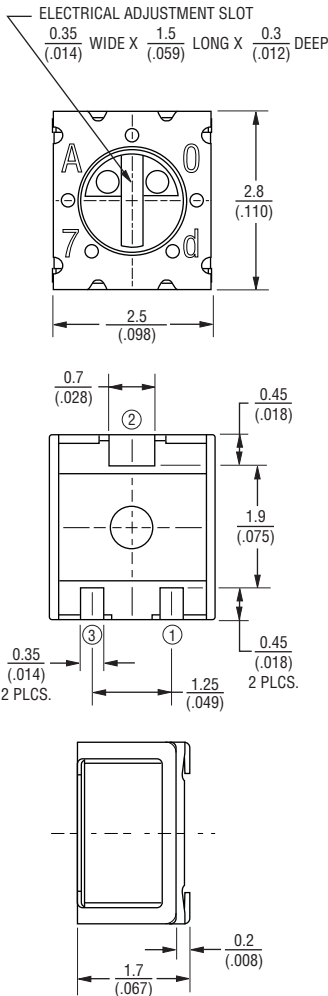

DIMENSIONS: $\frac{\text{MM}}{\text{(INCHES)}}$
 TOLERANCE: $\frac{\pm 0.30}{(\pm .012)}$

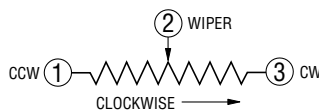

Recommended Land Pattern

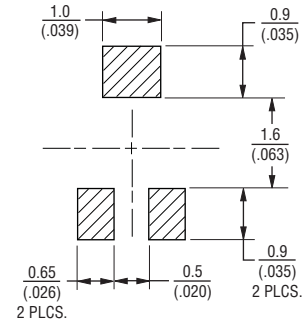

Standard Resistance Table

Resistance (Ohms)	Part Marking Code	Resistance Code
10	A1	100
20	U1	200
50	V1	500
100	A2	101
200	U2	201
500	V2	501
1,000	A3	102
2,000	U3	202
5,000	V3	502
10,000	A4	103
20,000	U4	203
50,000	V4	503
100,000	A5	104
200,000	U5	204
500,000	V5	504
1,000,000	A6	105
2,000,000	U6	205

Popular values listed in boldface. Consult factory for special resistances.

How To Order

3312 J - 1 - 502 E

Model _____
 Style _____
 Standard Product Indicator _____
 -1 = Standard Product
 Resistance Code _____
 Embossed Tape Designator _____
 E = 500 pcs./7 " Reel (MSL-1)

*RoHS Directive 2002/95/EC Jan. 27, 2003 including annex and RoHS Recast 2011/65/EU June 8, 2011.
 Specifications are subject to change without notice.

The device characteristics and parameters in this data sheet can and do vary in different applications and actual device performance may vary over time.
 Users should verify actual device performance in their specific applications.

3312 - 2 mm SMD TrimPot® Trimming Potentiometer

BOURNS®

Processing Information

Process Description	Materials	Temperature	Time Interval
1. Apply solder paste to test board (8 - 10 mil thick)	<ul style="list-style-type: none"> • Sn 96.5/Ag 3.0/Cu 0.5 Alloy water soluble or no clean solder paste • Single sided epoxy glass (G10) (UL approved) • PC board approx. 4x4x.06 in. 	Room temperature	
2. Place test units onto board	6 units/board		
3. Ramp up	Convection oven		2.5 °C ±0.5 °/second
4. Preheat (T _S)		150 °C to 190 °C	90 ±30 seconds
5. Time above liquidus (T _L)		220 °C	60-90 seconds
6. Peak temperature (T _P)			250 °C +0 °/-5 ° 10-20 sec. within 5 °C of peak
7. Ramp down		Room temperature	3 °C ±0.5 °C/second
8. Cleaning water clean profile	High pressure deionized water 65 PSI maximum	72 °F to 160 °F (22 °C to 71 °C)	As required

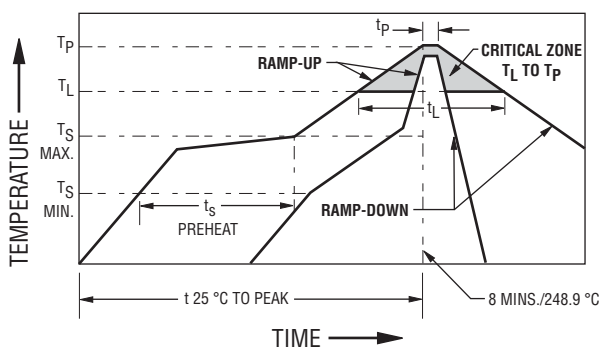

Specifications are subject to change without notice. The device characteristics and parameters in this data sheet can and do vary in different applications and actual device performance may vary over time. Users should verify actual device performance in their specific applications.

3312 - 2 mm SMD Trimpot® Trimming Potentiometer

BOURNS®

Packaging Specifications

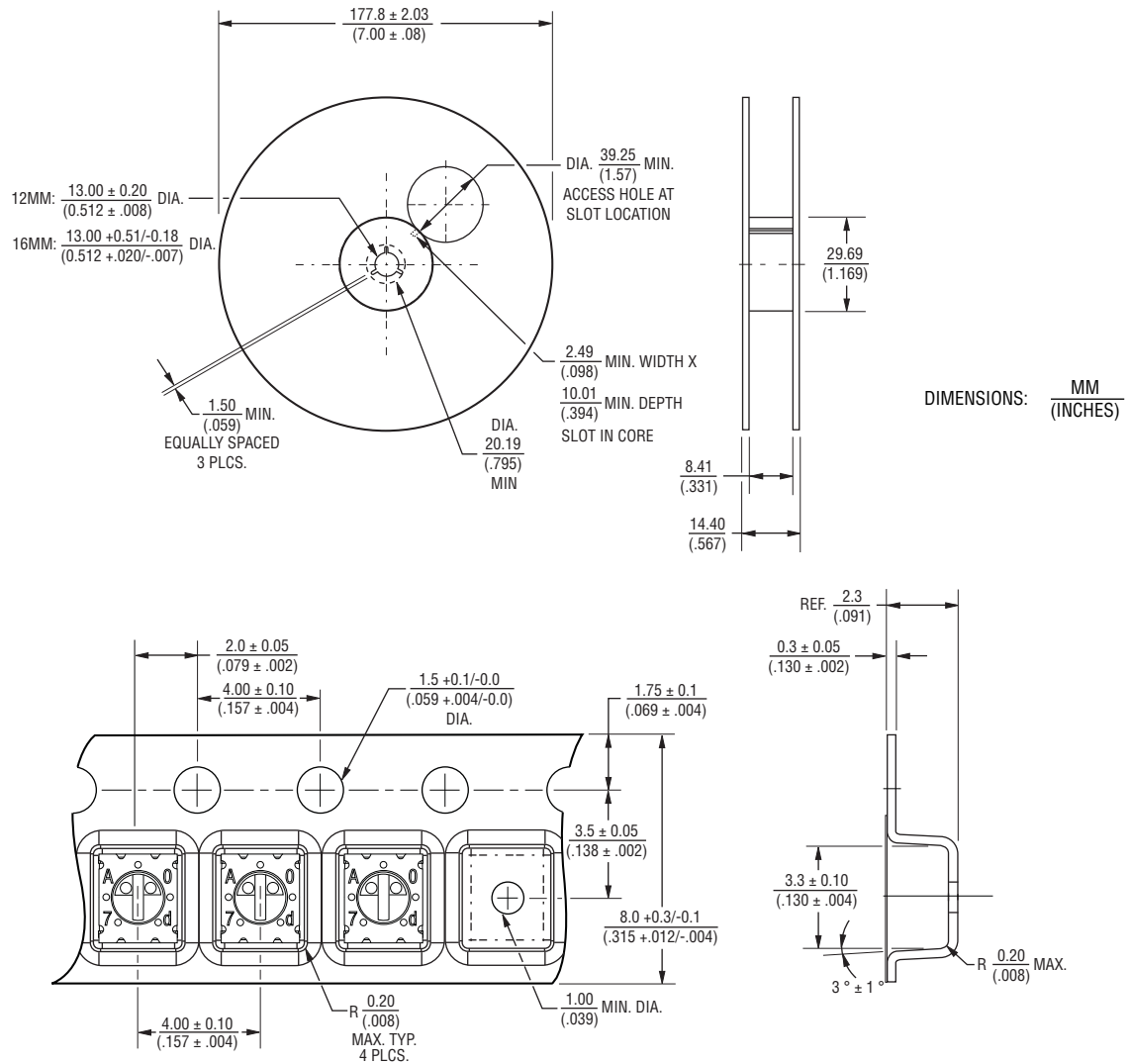

REV. 10/13

"Trimpot" is a registered trademark of Bourns, Inc.

Specifications are subject to change without notice.

The device characteristics and parameters in this data sheet can and do vary in different applications and actual device performance may vary over time. Users should verify actual device performance in their specific applications.