

Shock-Safe Fuseholder, 5 x 20 mm, Slot/Fingergrip, IP 40 / IP 67, IEC 60335-1



Fingergrip

250 VAC · 2.5 W / 10 A (VDE) 16 A (UL/CSA)

**Description**

- Meets the new requirements of IEC 60335-1 Ed. 4.0 for appliances in unattended use (clause 30.2.3). This includes the enhanced requirements of glow wire tests acc. to IEC 60695-2-11 to -13. Order numbers: xxxx.xxxx.15

Standards

- IEC 60127-6
- UL 4248-1 / UL 512
- CSA C22.2 no. 39

Approvals

- VDE License Number: 127216
- UL File Number: E39328

Applications

- Industrial electronic
- Household appliances
- Medical equipments

References

[General Product Information](#)

Weblinks

[Approvals](#), [RoHS](#), [CHINA-RoHS](#), [e-Store](#), [Distributor-Stock-Check](#), [Accessories](#), [Product Change Notification \(PCN\)](#)

Technical Data

Shocksafe Category	PC2
Fuse-Link	5 x 20 mm
Mounting	Panel Mount, Front-Side
Mounting	Fixing Nut
Terminal	Solder or Quick-Connect 4.8 x 0.5 mm
Rated Voltage	250 VAC
Rated Current	10 A (VDE), 16 A (UL/CSA)
Rated Power Acceptance IEC	2.5 W / 10 A @ Ta 23 °C Admissible power acceptance at higher ambient temperature see derating curves
Degree of Protection	IP 40 / IP 67
Protection Class	Suitable for appliances with protection class 1 or 2 acc. to IEC 61140
Admissible Ambient Air Temp.	-40 °C to 85 °C
Climatic Category	40/085/21 acc. to IEC 60068-1
Material: Socket	Thermoplastic, black, UL 94V-0
Material: Terminals	Tin-Plated Copper Alloy
Unit Weight (Socket/Cap)	5.7 g
Storage Conditions	0 °C to 60 °C, max. 70% r.h.
Product Marking	 Type, Voltage, Power Acc./Current Rating, Approvals

Soldering Methods	Iron
Solderability	350 °C / 2 sec acc. to IEC 60068-2-20, Test Ta, method 2
Resistance to Soldering Heat	350 °C / 10 sec acc. to IEC 60068-2-20, Test Tb, method 2
Contact Resistance	< 5 mΩ at 20 mV
Dielectric Strength	> 3 kV between L-N > 4 kV between L/N-PE (50 Hz; 1 min)
Impulse Withstand Voltage	> 2.5 kV between L-N > 6 kV between L/N-PE
Insulation Resistance	> 10 MΩ between L-N > 100 MΩ between L/N-PE (500 VDC; 1 min)
Overvoltage Category	I - II acc. to IEC 60664-1
Pollution Degree	1 - 3 acc. to IEC 60664-1
Resistance to Vibration	acc. to IEC 60068-2-6, test Fc
Admissible Torque on Fixing Nut	max 1.2 Nm
Panel Thickness s	max 6 mm

Abmessungen

41.5 mm

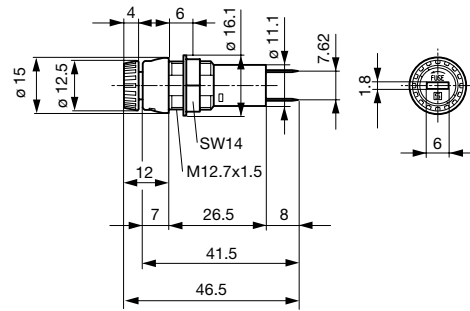
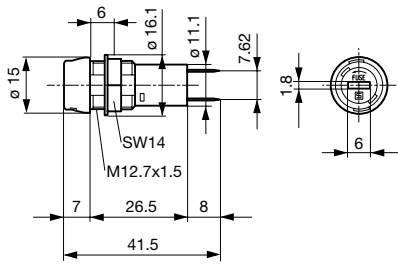

Variants 3101.0010 and 3101.0210

Variants Fingerrip 3101.0015 and 3101.0215

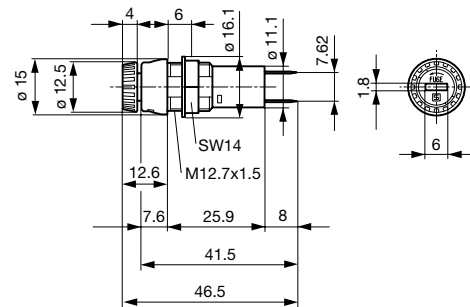
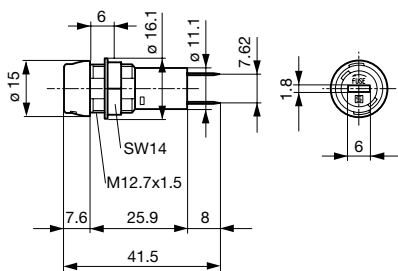

Variants 3101.0110 and 3101.0310

Variants Fingerrip 3101.0115 and 3101.0315

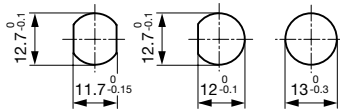

Mounting Holes

Derating Curves for Fuseholders

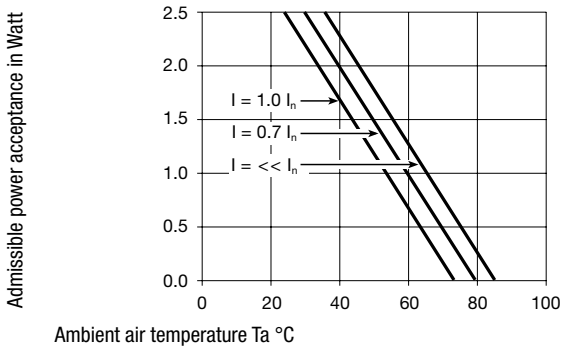

Variants

Holder	Cap	Terminal	Degree of Protection	Material	Remark	Order Number
●	Slot Knob	Solder	IP 40	Thermoplastic	-	3101.0010
●	Slot Knob	Solder	IP 40	Spec. Thermoplastic 1	Approvals pending	3101.0010.15
●	Slot Knob	Quick-Connect 4.8 x 0.5 mm	IP 40	Thermoplastic	-	3101.0210
●	Slot Knob	Quick-Connect 4.8 x 0.5 mm	IP 40	Spec. Thermoplastic 1	Approvals pending	3101.0210.15
●	Fingergrip	Solder	IP 40	Thermoplastic	-	3101.0015
●	Fingergrip	Solder	IP 40	Spec. Thermoplastic 1	Approvals pending	3101.0015.15
●	Fingergrip	Quick-Connect 4.8 x 0.5 mm	IP 40	Thermoplastic	-	3101.0215
●	Fingergrip	Quick-Connect 4.8 x 0.5 mm	IP 40	Spec. Thermoplastic 1	Approvals pending	3101.0215.15
●	Slot Knob	Solder	IP 67	Thermoplastic	-	3101.0110
●	Slot Knob	Solder	IP 67	Spec. Thermoplastic 1	Approvals pending	3101.0110.15
●	Slot Knob	Quick-Connect 4.8 x 0.5 mm	IP 67	Thermoplastic	-	3101.0310
●	Slot Knob	Quick-Connect 4.8 x 0.5 mm	IP 67	Spec. Thermoplastic 1	Approvals pending	3101.0310.15
●	Fingergrip	Solder	IP 67	Thermoplastic	-	3101.0115
●	Fingergrip	Solder	IP 67	Spec. Thermoplastic 1	Approvals pending	3101.0115.15
●	Fingergrip	Quick-Connect 4.8 x 0.5 mm	IP 67	Thermoplastic	-	3101.0315
●	Fingergrip	Quick-Connect 4.8 x 0.5 mm	IP 67	Spec. Thermoplastic 1	Approvals pending	3101.0315.15

Spec. thermoplastic meet the new requirements of IEC 60335-1 Ed. 4.0 for appliances in unattended use (clause 30.2.3). This includes the enhanced requirements of glow wire tests acc. to IEC 60695-2-11 to -13.

White and grey colours available on request

Packaging Unit Bulk 186 x 91 x 91 mm (100 pcs.)