

# 1PMT5.0AT3 Series

## Zener Transient Voltage Suppressor POWERMITE® Package

The 1PMT5.0AT3 Series is designed to protect voltage sensitive components from high voltage, high energy transients. Excellent clamping capability, high surge capability, low zener impedance and fast response time. The advanced packaging technique provides for a highly efficient micro miniature, space saving surface mount with its unique heat sink design. The POWERMITE has the same thermal performance as the SMA while being 50% smaller in footprint area, and delivering one of the lowest height profiles (1.1 mm) in the industry. Because of its small size, it is ideal for use in cellular phones, portable devices, business machines, power supplies and many other industrial/consumer applications.

### Specification Features:

- Stand-off Voltage: 5 – 58 Volts
- Peak Power – 175 Watts @ 1 ms
- Maximum Clamp Voltage @ Peak Pulse Current
- Low Leakage
- Response Time is Typically < 1 ns
- ESD Rating of Class 3 (> 16 kV) per Human Body Model
- Low Profile – Maximum Height of 1.1 mm
- Integral Heat Sink/Locking Tabs
- Full Metallic Bottom Eliminates Flux Entrapment
- Small Footprint – Footprint Area of 8.45 mm<sup>2</sup>
- Supplied in 12 mm Tape and Reel – 12,000 Units per Reel
- POWERMITE is JEDEC Registered as DO-216AA
- Cathode Indicated by Polarity Band

### Mechanical Characteristics:

**CASE:** Void-free, transfer-molded, thermosetting plastic

**FINISH:** All external surfaces are corrosion resistant and leads are readily solderable

**MOUNTING POSITION:** Any

**MAXIMUM CASE TEMPERATURE FOR SOLDERING PURPOSES:**  
260°C for 10 Seconds



ON Semiconductor™

<http://onsemi.com>

**PLASTIC SURFACE MOUNT  
ZENER OVERVOLTAGE  
TRANSIENT SUPPRESSOR  
5 – 58 VOLTS  
175 WATT PEAK POWER**

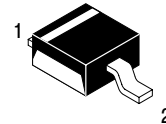
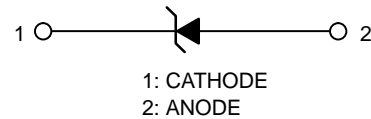

**POWERMITE  
CASE 457  
PLASTIC**

### MARKING DIAGRAM

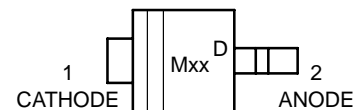

Mxx = Specific Device Code  
xx = 5 – 58  
(See Table Next Page)  
D = Date Code

### ORDERING INFORMATION

Device	Package	Shipping
1PMTxxAT3	POWERMITE	12,000/Tape & Reel

### LEAD ORIENTATION IN TAPE:

Cathode (Short) Lead to Sprocket Holes

# 1PMT5.0AT3 Series

## MAXIMUM RATINGS

Rating	Symbol	Value	Unit
Maximum $P_{pk}$ Dissipation @ $T_A = 25^\circ\text{C}$ , (PW–10/1000 $\mu\text{s}$ ) (Note 1.)	$P_{pk}$	175	W
Maximum $P_{pk}$ Dissipation @ $T_A = 25^\circ\text{C}$ , (PW–8/20 $\mu\text{s}$ ) (Note 1.)	$P_{pk}$	1000	W
DC Power Dissipation @ $T_A = 25^\circ\text{C}$ (Note 2.) Derate above $25^\circ\text{C}$	$P_D$	500	mW
Thermal Resistance from Junction to Ambient	$R_{\theta JA}$	4.0	$\text{mW}/^\circ\text{C}$
Thermal Resistance from Junction to Lead (Anode)	$R_{\theta Janode}$	248	$^\circ\text{C}/\text{W}$
Maximum DC Power Dissipation (Note 3.) Thermal Resistance from Junction to Tab (Cathode)	$P_D$ $R_{\theta Jcathode}$	3.2 23	W $^\circ\text{C}/\text{W}$
Operating and Storage Temperature Range	$T_J, T_{stg}$	–55 to +150	$^\circ\text{C}$

1. Non-repetitive current pulse at  $T_A = 25^\circ\text{C}$ .
2. Mounted with recommended minimum pad size, DC board FR–4.
3. At Tab (Cathode) temperature,  $T_{tab} = 75^\circ\text{C}$

**ELECTRICAL CHARACTERISTICS** ( $T_A = 25^\circ\text{C}$  unless otherwise noted,  $V_F = 3.5\text{ V Max. @ } I_F$  (Note 4.) = 35 A)

Symbol	Parameter
$I_{PP}$	Maximum Reverse Peak Pulse Current
$V_C$	Clamping Voltage @ $I_{PP}$
$V_{RWM}$	Working Peak Reverse Voltage
$I_R$	Maximum Reverse Leakage Current @ $V_{RWM}$
$V_{BR}$	Breakdown Voltage @ $I_T$
$I_T$	Test Current
$I_F$	Forward Current
$V_F$	Forward Voltage @ $I_F$

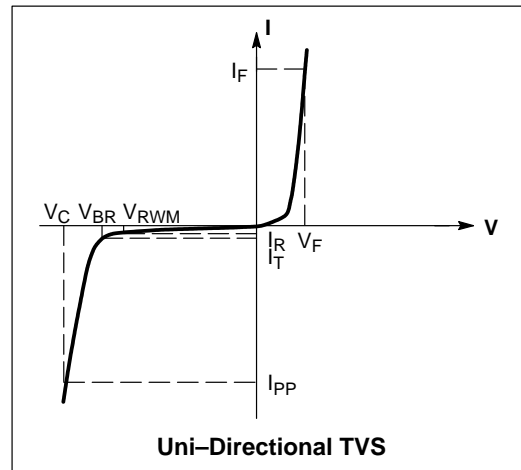

**ELECTRICAL CHARACTERISTICS** ( $T_L = 30^\circ\text{C}$  unless otherwise noted,  $V_F = 1.25\text{ Volts @ } 200\text{ mA}$ )

Device	Marking	$V_{RWM}$	$V_{BR} @ I_T$ (V) (Note 6.)			$I_T$	$I_R @ V_{RWM}$	$V_C @ I_{PP}$	$I_{PP}$ (A)
		(Note 5.)	Min	Nom	Max	(mA)	( $\mu\text{A}$ )	(V)	(Note 7.)
1PMT5.0AT3	MKE	5.0	6.4	6.7	7.0	10	800	9.2	19
1PMT7.0AT3	MKM	7.0	7.78	8.2	8.6	10	500	12	14.6
1PMT12AT3	MLE	12	13.3	14.0	14.7	1.0	5.0	19.9	8.8
1PMT16AT3	MLP	16	17.8	18.75	19.7	1.0	5.0	26	7.0
1PMT18AT3	MLT	18	20.0	21.0	22.1	1.0	5.0	29.2	6.0
1PMT22AT3	MLX	22	24.4	25.6	26.9	1.0	5.0	35.5	4.9
1PMT24AT3	MLZ	24	26.7	28.1	29.5	1.0	5.0	38.9	4.5
1PMT26AT3	MME	26	28.9	30.4	31.9	1.0	5.0	42.1	4.2
1PMT28AT3	MMG	28	31.1	32.8	34.4	1.0	5.0	45.4	3.9
1PMT30AT3	MMK	30	33.3	35.1	36.8	1.0	5.0	48.4	3.6
1PMT33AT3	MMM	33	36.7	38.7	40.6	1.0	5.0	53.3	3.3
1PMT36AT3	MMP	36	40.0	42.1	44.2	1.0	5.0	58.1	3.0
1PMT40AT3	MMR	40	44.4	46.8	49.1	1.0	5.0	64.5	2.7
1PMT48AT3	MMX	48	53.3	56.1	58.9	1.0	5.0	77.4	2.3
1PMT51AT3	MMZ	51	56.7	59.7	62.7	1.0	5.0	82.4	2.1
1PMT58AT3	MNG	58	64.4	67.8	71.2	1.0	5.0	93.6	1.9

4. 1/2 sine wave (or equivalent square wave), PW = 8.3 ms, duty cycle = 4 pulses per minute maximum.
5. A transient suppressor is normally selected according to the Working Peak Reverse Voltage ( $V_{RWM}$ ) which should be equal to or greater than the DC or continuous peak operating voltage level.
6.  $V_{BR}$  measured at pulse test current  $I_T$  at ambient temperature of  $25^\circ\text{C}$ .
7. Surge current waveform per Figure 2 and derate per Figure 4.

# 1PMT5.0AT3 Series

## TYPICAL PROTECTION CIRCUIT

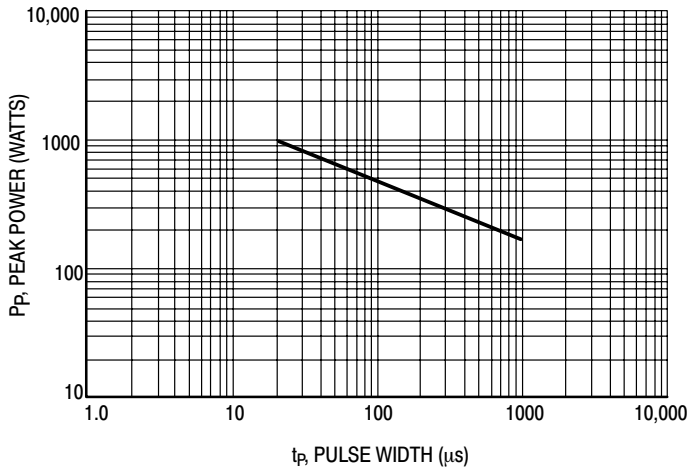
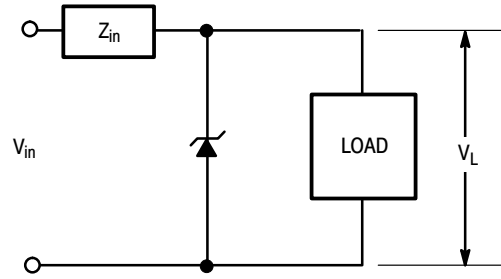

Figure 1. Pulse Rating Curve

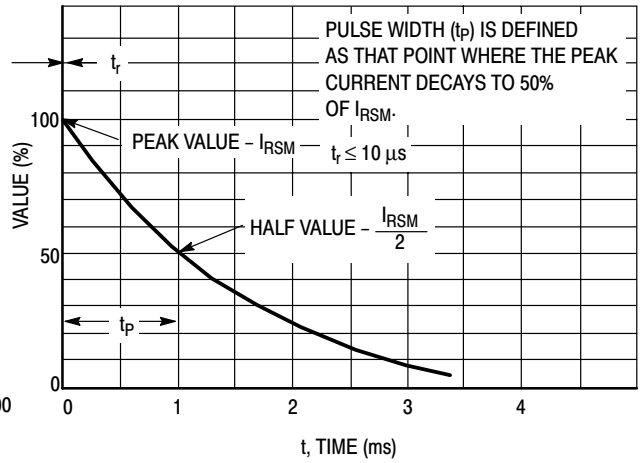

Figure 2. 10 X 1000  $\mu$ s Pulse Waveform

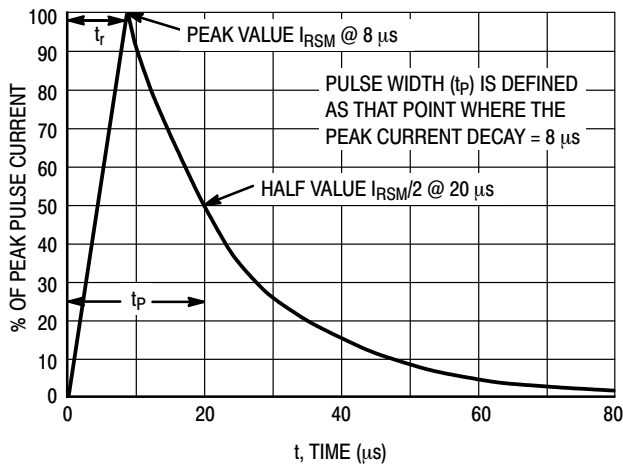

Figure 3. 8 X 20  $\mu$ s Pulse Waveform

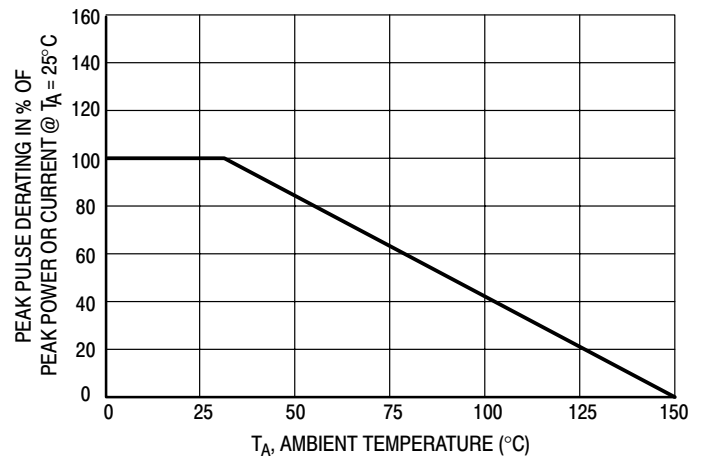

Figure 4. Pulse Derating Curve

# 1PMT5.0AT3 Series

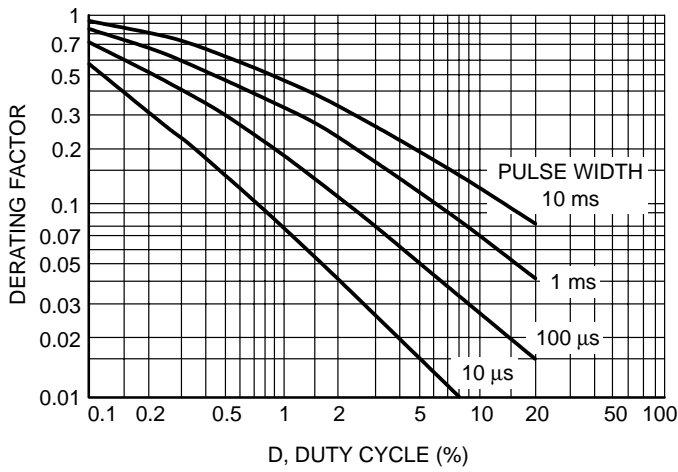

Figure 5. Typical Derating Factor for Duty Cycle

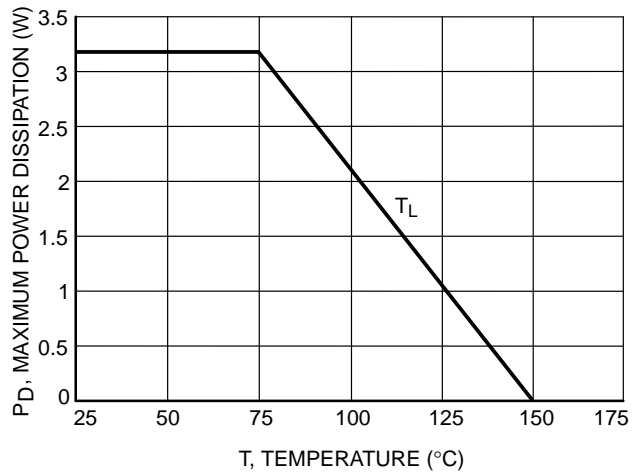

Figure 6. Steady State Power Derating

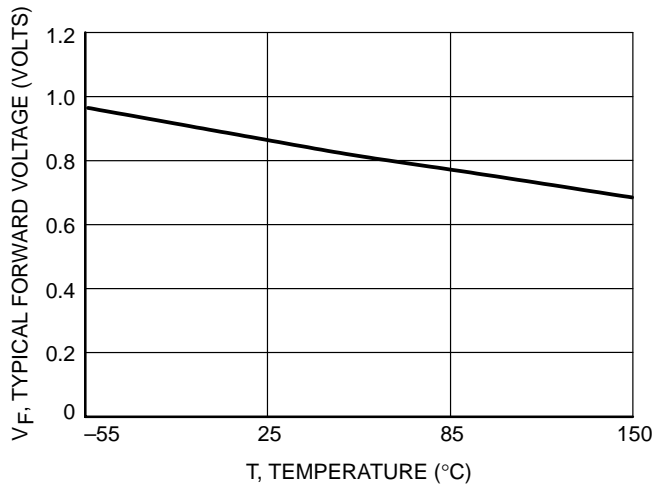

Figure 7. Forward Voltage

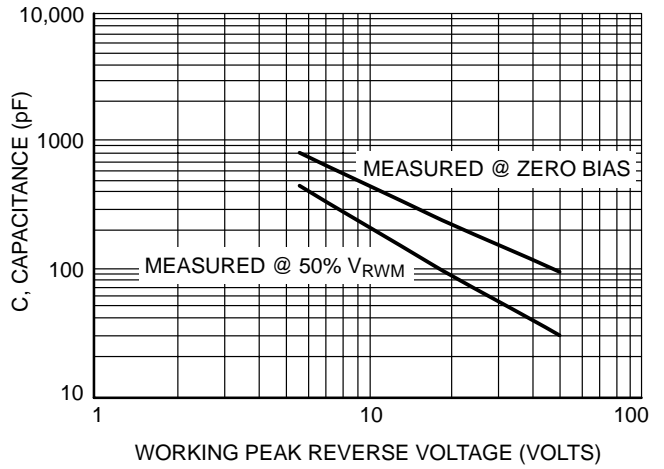

Figure 8. Capacitance versus Working Peak Reverse Voltage

# 1PMT5.0AT3 Series

## TYPICAL SOLDER HEATING PROFILE

For any given circuit board, there will be a group of control settings that will give the desired heat pattern. The operator must set temperatures for several heating zones and a figure for belt speed. Taken together, these control settings make up a heating “profile” for that particular circuit board. On machines controlled by a computer, the computer remembers these profiles from one operating session to the next. Figure 9 shows a typical heating profile for use when soldering a surface mount device to a printed circuit board. This profile will vary among soldering systems, but it is a good starting point. Factors that can affect the profile include the type of soldering system in use, density and types of components on the board, type of solder used, and the type of board or substrate material being used. This profile shows temperature versus time.

The line on the graph shows the actual temperature that might be experienced on the surface of a test board at or near a central solder joint. The two profiles are based on a high density and a low density board. The Vitronics SMD310 convection/infrared reflow soldering system was used to generate this profile. The type of solder used was 62/36/2 Tin Lead Silver with a melting point between 177–189°C. When this type of furnace is used for solder reflow work, the circuit boards and solder joints tend to heat first. The components on the board are then heated by conduction. The circuit board, because it has a large surface area, absorbs the thermal energy more efficiently, then distributes this energy to the components. Because of this effect, the main body of a component may be up to 30 degrees cooler than the adjacent solder joints.

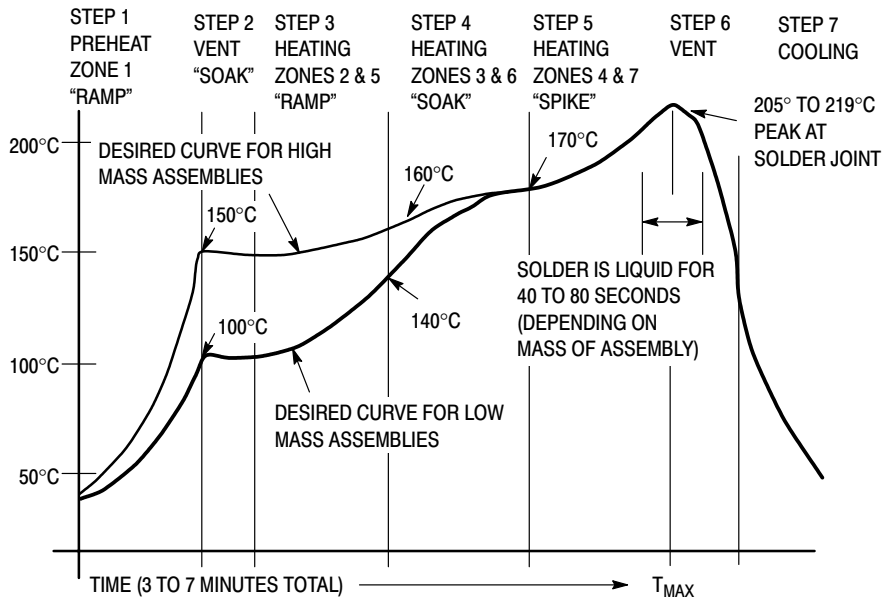

Figure 9. Typical Solder Heating Profile

INFORMATION FOR USING THE POWERMITE SURFACE MOUNT PACKAGE

MINIMUM RECOMMENDED FOOTPRINT FOR SURFACE MOUNTED APPLICATIONS

Surface mount board layout is a critical portion of the total design. The footprint for the semiconductor packages must be the correct size to insure proper solder connection

interface between the board and the package. With the correct pad geometry, the packages will self align when subjected to a solder reflow process.

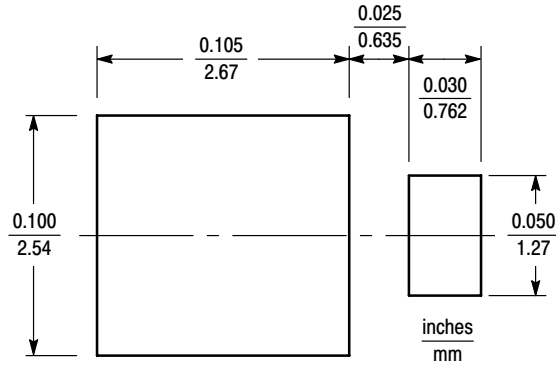

POWERMITE

POWERMITE POWER DISSIPATION

The power dissipation of the Powermite is a function of the drain pad size. This can vary from the minimum pad size for soldering to a pad size given for maximum power dissipation. Power dissipation for a surface mount device is determined by  $T_{J(max)}$ , the maximum rated junction temperature of the die,  $R_{\theta JA}$ , the thermal resistance from the device junction to ambient, and the operating temperature,  $T_A$ . Using the values provided on the data sheet for the Powermite package,  $P_D$  can be calculated as follows:

$$P_D = \frac{T_{J(max)} - T_A}{R_{\theta JA}}$$

The values for the equation are found in the maximum ratings table on the data sheet. Substituting these values into the equation for an ambient temperature  $T_A$  of 25°C,

one can calculate the power dissipation of the device which in this case is 504 milliwatts.

$$P_D = \frac{150^\circ\text{C} - 25^\circ\text{C}}{248^\circ\text{C/W}} = 504 \text{ milliwatts}$$

The 248°C/W for the Powermite package assumes the use of the recommended footprint on a glass epoxy printed circuit board to achieve a power dissipation of 504 milliwatts. There are other alternatives to achieving higher power dissipation from the Powermite package. Another alternative would be to use a ceramic substrate or an aluminum core board such as Thermal Clad®. Using a board material such as Thermal Clad, an aluminum core board, the power dissipation can be doubled using the same footprint.

SOLDERING PRECAUTIONS

The melting temperature of solder is higher than the rated temperature of the device. When the entire device is heated to a high temperature, failure to complete soldering within a short time could result in device failure. Therefore, the following items should always be observed in order to minimize the thermal stress to which the devices are subjected.

- Always preheat the device.
- The delta temperature between the preheat and soldering should be 100°C or less.\*
- When preheating and soldering, the temperature of the leads and the case must not exceed the maximum temperature ratings as shown on the data sheet. When using infrared heating with the reflow soldering method, the difference shall be a maximum of 10°C.

- The soldering temperature and time shall not exceed 260°C for more than 10 seconds.
- When shifting from preheating to soldering, the maximum temperature gradient shall be 5°C or less.
- After soldering has been completed, the device should be allowed to cool naturally for at least three minutes. Gradual cooling should be used as the use of forced cooling will increase the temperature gradient and result in latent failure due to mechanical stress.
- Mechanical stress or shock should not be applied during cooling.

\* Soldering a device without preheating can cause excessive thermal shock and stress which can result in damage to the device.

# 1PMT5.0AT3 Series

## OUTLINE DIMENSIONS

# Transient Voltage Suppressor – Surface Mounted

## 175 Watt Peak Power

POWERMITE  
CASE 457-04  
ISSUE D

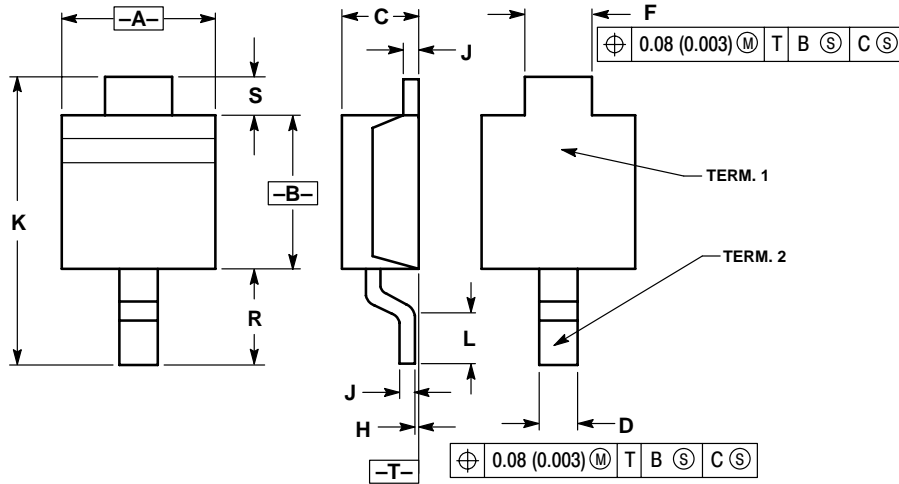

NOTES:

1. DIMENSIONING AND TOLERANCING PER ANSI Y14.5M, 1982.
2. CONTROLLING DIMENSION: MILLIMETER.
3. DIMENSION A DOES NOT INCLUDE MOLD FLASH, PROTRUSIONS OR GATE BURRS. MOLD FLASH, PROTRUSIONS OR GATE BURRS SHALL NOT EXCEED 0.15 (0.006) PER SIDE.

DIM	MILLIMETERS		INCHES	
	MIN	MAX	MIN	MAX
A	1.75	2.05	0.069	0.081
B	1.75	2.18	0.069	0.086
C	0.85	1.15	0.033	0.045
D	0.40	0.69	0.016	0.027
F	0.70	1.00	0.028	0.039
H	-0.05	+0.10	-0.002	+0.004
J	0.10	0.25	0.004	0.010
K	3.60	3.90	0.142	0.154
L	0.50	0.80	0.020	0.031
R	1.20	1.50	0.047	0.059
S	0.50 REF		0.019 REF	

# 1PMT5.0AT3 Series

POWERMITE is a registered trademark of and used under a license from Microsemi Corporation.  
Thermal Clad is a registered trademark of the Bergquist Company.

**ON Semiconductor** and  are trademarks of Semiconductor Components Industries, LLC (SCILLC). SCILLC reserves the right to make changes without further notice to any products herein. SCILLC makes no warranty, representation or guarantee regarding the suitability of its products for any particular purpose, nor does SCILLC assume any liability arising out of the application or use of any product or circuit, and specifically disclaims any and all liability, including without limitation special, consequential or incidental damages. "Typical" parameters which may be provided in SCILLC data sheets and/or specifications can and do vary in different applications and actual performance may vary over time. All operating parameters, including "Typicals" must be validated for each customer application by customer's technical experts. SCILLC does not convey any license under its patent rights nor the rights of others. SCILLC products are not designed, intended, or authorized for use as components in systems intended for surgical implant into the body, or other applications intended to support or sustain life, or for any other application in which the failure of the SCILLC product could create a situation where personal injury or death may occur. Should Buyer purchase or use SCILLC products for any such unintended or unauthorized application, Buyer shall indemnify and hold SCILLC and its officers, employees, subsidiaries, affiliates, and distributors harmless against all claims, costs, damages, and expenses, and reasonable attorney fees arising out of, directly or indirectly, any claim of personal injury or death associated with such unintended or unauthorized use, even if such claim alleges that SCILLC was negligent regarding the design or manufacture of the part. SCILLC is an Equal Opportunity/Affirmative Action Employer.

## PUBLICATION ORDERING INFORMATION

### **NORTH AMERICA Literature Fulfillment:**

Literature Distribution Center for ON Semiconductor  
P.O. Box 5163, Denver, Colorado 80217 USA  
**Phone:** 303-675-2175 or 800-344-3860 Toll Free USA/Canada  
**Fax:** 303-675-2176 or 800-344-3867 Toll Free USA/Canada  
**Email:** ONlit@hibbertco.com  
Fax Response Line: 303-675-2167 or 800-344-3810 Toll Free USA/Canada

**N. American Technical Support:** 800-282-9855 Toll Free USA/Canada

**EUROPE:** LDC for ON Semiconductor – European Support

**German Phone:** (+1) 303-308-7140 (Mon-Fri 2:30pm to 7:00pm CET)  
**Email:** ONlit-german@hibbertco.com  
**French Phone:** (+1) 303-308-7141 (Mon-Fri 2:00pm to 7:00pm CET)  
**Email:** ONlit-french@hibbertco.com  
**English Phone:** (+1) 303-308-7142 (Mon-Fri 12:00pm to 5:00pm GMT)  
**Email:** ONlit@hibbertco.com

**EUROPEAN TOLL-FREE ACCESS\*: 00-800-4422-3781**

\*Available from Germany, France, Italy, UK, Ireland

### **CENTRAL/SOUTH AMERICA:**

**Spanish Phone:** 303-308-7143 (Mon-Fri 8:00am to 5:00pm MST)  
**Email:** ONlit-spanish@hibbertco.com  
**Toll-Free from Mexico:** Dial 01-800-288-2872 for Access –  
then Dial 866-297-9322

**ASIA/PACIFIC:** LDC for ON Semiconductor – Asia Support

**Phone:** 1-303-675-2121 (Tue-Fri 9:00am to 1:00pm, Hong Kong Time)  
**Toll Free from Hong Kong & Singapore:**  
**001-800-4422-3781**  
**Email:** ONlit-asia@hibbertco.com

**JAPAN:** ON Semiconductor, Japan Customer Focus Center

4-32-1 Nishi-Gotanda, Shinagawa-ku, Tokyo, Japan 141-0031  
**Phone:** 81-3-5740-2700  
**Email:** r14525@onsemi.com

**ON Semiconductor Website:** <http://onsemi.com>

For additional information, please contact your local Sales Representative.