

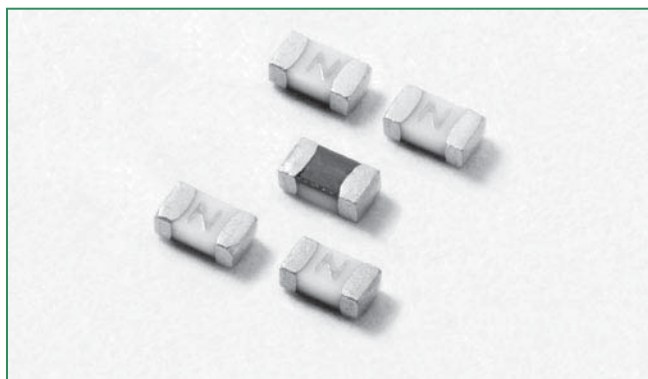

**RoHS Pb HF 438 Series – 0603 Fast-Acting Fuse**

**Description**

The 438 Series is a 100% Lead-free, RoHS compliant and Halogen-free fuse series designed specifically to provide over-current protection to circuits that operate under high working ambient temperature up to 150°C.

The general design ensures excellent temperature stability and performance reliability.

The high I<sup>2</sup>t values which is typical in the Littelfuse Ceramic Fuse family ensure high inrush current withstand capability.

**Agency Approvals**

AGENCY	AGENCY FILE NUMBER	AMPERE RANGE
	E10480	0.250A – 6A
	LR29862	0.250A – 6A

**Features**

- Operating Temperature from -55°C to +150°C
- Suitable for both leaded and lead-free reflow / wave soldering
- 100% Lead-free, RoHS compliant and Halogen-free



**Electrical Characteristics for Series**

% of Ampere Rating	Ampere Rating	Opening Time at 25°C
100%	0.250A – 6A	4 Hours, Minimum
250%	0.250A – 6A	5 Seconds, Maximum

**Applications**

- Handheld Electronics
- LCD Displays
- Battery Packs
- Hard Disk Drives
- SD Memory Cards
- Automotive Electronics

**Electrical Specifications by Item**

Ampere Rating (A)	Amp Code	Max. Voltage Rating (V)	Interrupting Rating	Nominal Resistance (Ohms) <sup>2</sup>	Nominal Melting I <sup>2</sup> t (A <sup>2</sup> Sec.) <sup>3</sup>	Nominal Voltage Drop At Rated Current (V) <sup>4</sup>	Nominal Power Dissipation At Rated Current (W)	Agency Approvals	
									
0.25	.250	32	50 A @ 32 VDC	2.024	0.0017	0.550	0.138	x	x
0.375	.375	32		1.247	0.0041	0.488	0.183	x	x
0.5	.500	32		0.829	0.0100	0.486	0.243	x	x
0.75	.750	32		0.466	0.0281	0.378	0.284	x	x
1	001.	32		0.310	0.0593	0.351	0.351	x	x
1.25	1.25	32		0.200	0.0510	0.365	0.456	x	x
1.5	01.5	32		0.174	0.0902	0.368	0.552	x	x
1.75	1.75	32		0.125	0.1440	0.360	0.540	x	x
2	002.	32		0.051	0.1490	0.107	0.214	x	x
2.5	02.5	32		0.0324	0.1977	0.095	0.238	x	x
3	003.	32		0.0252	0.2922	0.093	0.279	x	x
3.5	03.5	32		0.0203	0.4752	0.082	0.287	x	x
4	004.	32		0.0169	0.6920	0.079	0.316	x	x
5	005.	32		0.0113	0.7398	0.074	0.370	x	x
6	006.	24		50 A @ 24 VDC	0.0087	1.3838	0.072	0.432	x

Notes:

1. AC Interrupting Rating tested at rated voltage with unity power factor. DC Interrupting Rating tested at rated voltage with time constant < 0.8 msec.
2. Nominal Resistance measured with < 10% rated current.
3. Nominal Melting I<sup>2</sup>t measured at 1 msec. opening time.
4. Nominal Voltage Drop measured at rated current after temperature has stabilized.

Devices designed to carry rated current for 4 hours minimum. It is recommended that devices be operated continuously at no more than 80% rated current. See "Temperature Derating Curve" for additional derating information.

Devices designed to be mounted with marking code facing up.

### Temperature Derating Curve

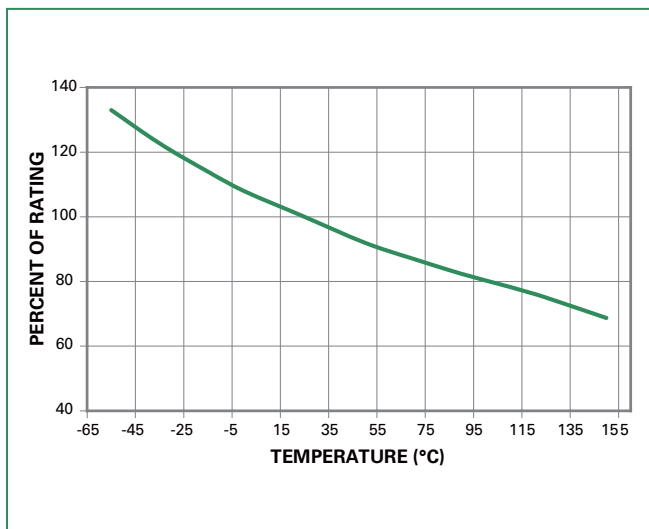

Note:

1. Derating depicted in this curve is in addition to the standard derating of 20% for continuous operation.

Example:

For continuous operation at 75 degrees celsius, the fuse should be derated as follows:

$$I = (0.80)(0.85)I_{RAT} = (0.68)I_{RAT}$$

### Average Time Current Curves

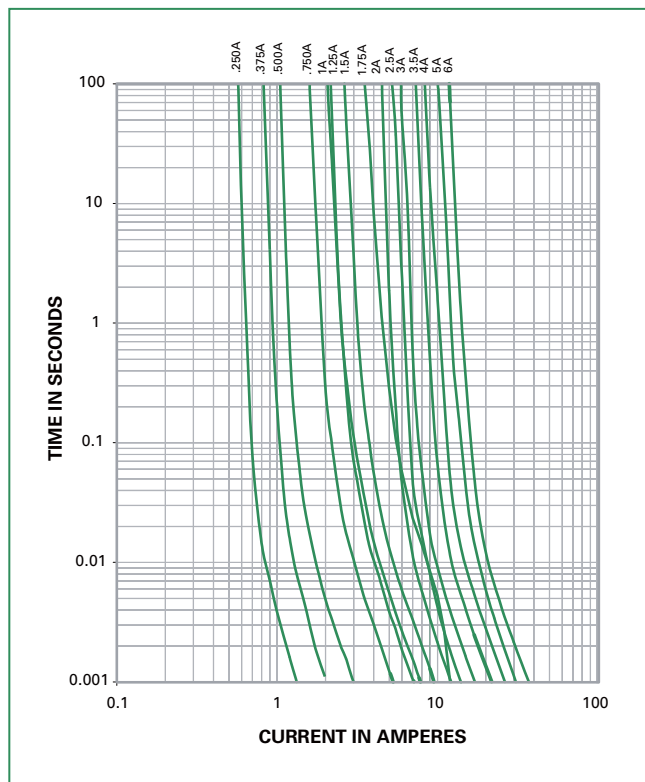

### Soldering Parameters

Reflow Condition		Pb – free assembly
Pre Heat	- Temperature Min ( $T_{s(min)}$ )	150°C
	- Temperature Max ( $T_{s(max)}$ )	200°C
	- Time (Min to Max) ( $t_s$ )	60 – 180 seconds
Average Ramp-up Rate (Liquidus Temp ( $T_L$ ) to peak)		3°C/second max.
$T_{s(max)}$ to $T_L$ - Ramp-up Rate		5°C/second max.
Reflow	- Temperature ( $T_L$ ) (Liquidus)	217°C
	- Temperature ( $t_L$ )	60 – 150 seconds
Peak Temperature ( $T_p$ )		260 <sup>+0/-5</sup> °C
Time within 5°C of actual peak Temperature ( $t_p$ )		10 – 30 seconds
Ramp-down Rate		6°C/second max.
Time 25°C to peak Temperature ( $T_p$ )		8 minutes max.
Do not exceed		260°C

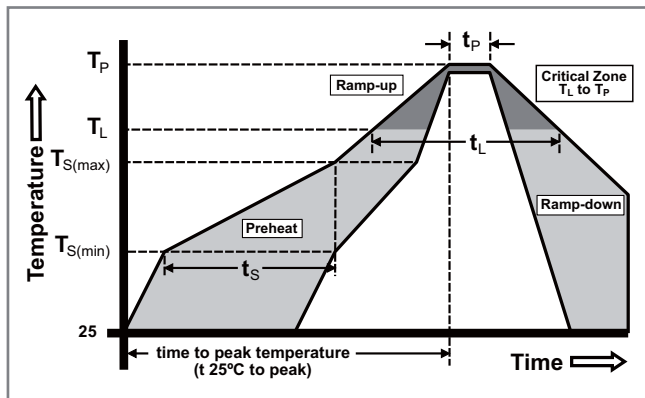

Wave Soldering	260°C, 10 seconds max.
----------------	------------------------

### Product Characteristics

<b>Materials</b>	<b>Body:</b> Advanced Ceramic <b>Terminations:</b> Ag / Ni / Sn (100% Lead-free) <b>Element Cover Coating:</b> Lead-free Glass
<b>Moisture Sensitivity Level</b>	IPC/JEDEC J-STD-020C, Level 1
<b>Solderability</b>	IPC/EIC/JEDEC J-STD-002B, Condition B
<b>Humidity</b>	MIL-STD-202, Method 103B, Conditions D
<b>ESD Immunity</b>	IEC 61000-4-2, 8kV Direct
<b>Resistance to Solder Heat</b>	MIL-STD-202, Method 210F, Condition B

<b>Moisture Resistance</b>	MIL-STD-202, Method 106G
<b>Thermal Shock</b>	MIL-STD-202, Method 107G, Condition B-3
<b>Mechanical Shock</b>	MIL-STD-202, Method 213B, Condition A
<b>Vibration</b>	MIL-STD-202, Method 201A
<b>Vibration, High Frequency</b>	MIL-STD-202, Method 204D, Condition D
<b>Dissolution of Metallization</b>	IPC/EIC/JEDEC J-STD-002B, Condition D
<b>Terminal Strength</b>	IEC 60127-4

### Dimensions

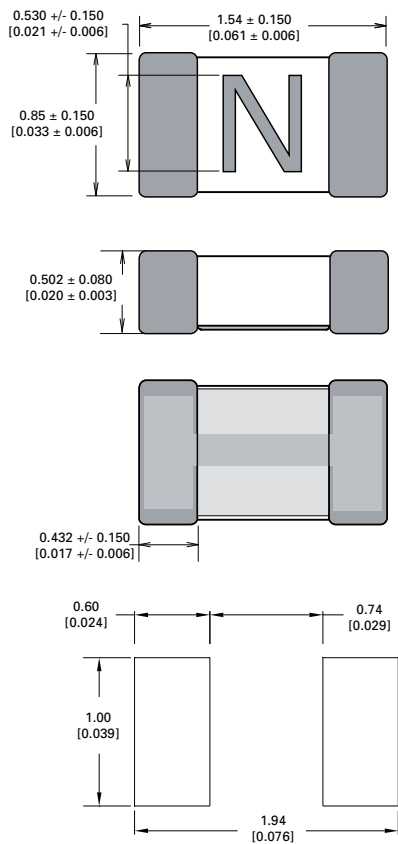

### Part Marking System

Amp Code	Marking Code
.250	<b>D</b>
.375	<b>E</b>
.500	<b>F</b>
.750	<b>G</b>
001.	<b>H</b>
1.25	<b>J</b>
01.5	<b>K</b>
1.75	<b>L</b>
002.	<b>N</b>
02.5	<b>O</b>
003.	<b>P</b>
03.5	<b>R</b>
004.	<b>S</b>
005.	<b>T</b>
006.	<b>U</b>

### Part Numbering System

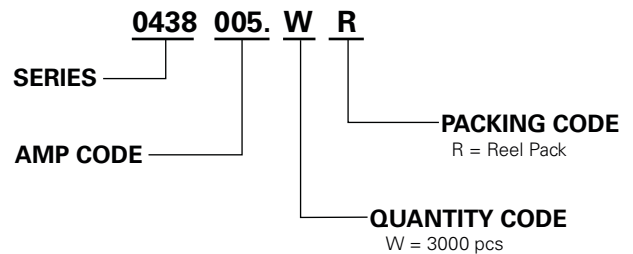

### Packaging

Packaging Option	Packaging Specification	Quantity	Quantity & Packaging Code
8mm Tape and Reel	EIA-481-1 (IEC 286, part 3)	3000	WR

