

Voltage selector switch, 3 stages, step switch, panel mounting



See below:

[Approvals and Compliances](#)

Description

- Voltage Selector , 3 stages
- Step switch
- Solder terminals

References

Alternative: version for PCB mounting [SWM2 \(Print\)](#)

Technical Data

Ratings	IEC: 6.3 A / 250 VAC; 50 Hz	Solderability	350 °C / 2 sec acc. to IEC 60068-2-20, Test Ta, method 2	
	UL: 10 A / 250 VAC; 60 Hz		Resistance to Soldering Heat	350 °C / 10 sec acc. to IEC 60068-2-20, Test Tb, method 2
	CSA: 10 A / 250 VAC; 60 Hz			Insulation Resistance
Mounting	Panel mount from front side	Contact Resistance	< 10mΩ at 20 mV	
Attachment	Screw-on mounting	Dielectric Strength	> 2kVAC between L-N > 4kVAC between L/N-PE (1min; 50Hz)	
Terminal	Solder	Clearance and Creepage Distance	> 3mm > 8mm between L/N-PE	
Number of Stages	3	Resistance to Vibration	acc. to IEC 60068-2-6, test Fc	
Lifetime	300 operating cycles (without load)	Panel Thickness S	max 8mm	
Degree of Protection	IP40			
Protection Class	Suitable for appliances with protection class II acc. to IEC 61140			
Allowable Operation Temperature	-40 °C to 85 °C			
Climatic Category	25/85/21 acc. to IEC 60068-1			
Material: Socket	Thermoplastic, black, UL 94V-0			
Weight	6.5 g			

Approvals and Compliances

Detailed information on product approvals, code requirements, usage instructions and detailed test conditions can be looked up in [Details about Approvals](#)

SCHURTER products are designed for use in industrial environments. They have approvals from independent testing bodies according to national and international standards. Products with specific characteristics and requirements such as required in the automotive sector according to IATF 16949, medical technology according to ISO 13485 or in the aerospace industry can be offered exclusively with customer-specific, individual agreements by SCHURTER.

Approvals



The approval mark is used by the testing authorities to certify compliance with the safety requirements placed on electronic products.

Approval Reference Type: SWM

Approval Logo	Certificates	Certification Body	Description
	VDE Approvals	VDE	Certificate Number:
	UL Approvals	UL	UL File Number: E72661



Product standards

Product standards that are referenced

Organization	Design	Standard	Description
	Designed according to	UL 508	Industrial control equipment
	Designed according to	CSA C22.2 no. 55	Fuseholder general requirements



Application standards

Application standards where the product can be used

Organization	Design	Standard	Description
	Designed for applications acc.	IEC/UL 60950	IEC 60950-1 includes the basic requirements for the safety of information technology equipment.
	Designed for applications acc.	IEC 60335-1	Safety of electrical appliances for household and similar purposes. Meets the requirements for appliances in unattended use. This includes the enhanced requirements of glow wire tests acc. to IEC 60695-2-11 or -12 & -13.

Compliances

The product complies with following Guide Lines

Identification	Details	Initiator	Description
	CE declaration of conformity	SCHURTER AG	The CE marking declares that the product complies with the applicable requirements laid down in the harmonisation of Community legislation on its affixing in accordance with EU Regulation 765/2008.
	REACH	SCHURTER AG	On 1 June 2007, Regulation (EC) No 1907/2006 on the Registration, Evaluation, Authorization and Restriction of Chemicals 1 (abbreviated as "REACH") entered into force.

Dimension [mm]

23 mm

Panel mounting hole

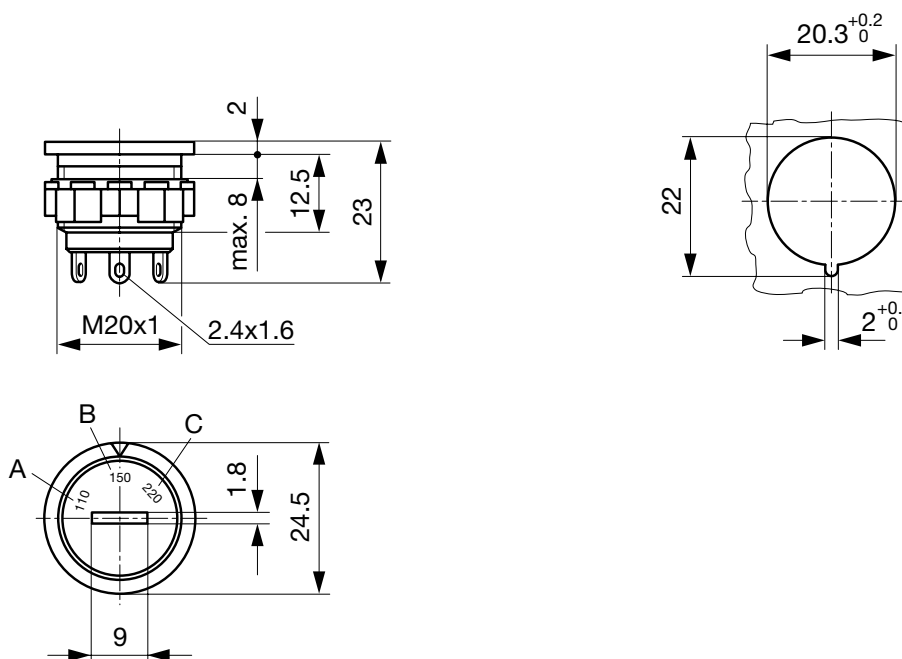

Diagrams

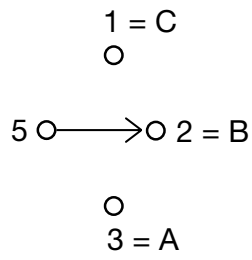

All Variants

Letterings			Order Number
A	B	C	
110	150	220	0033.4001
110	220	240	0033.4002
220	240		0033.4003
200	220	240	0033.4004
220	240	250	0033.4006
100	115	230	0033.4008
220	230	240	0033.4011
			0033.4014
115	220	240	0033.4019
220 V	230 V	240 V	0033.4028
4	8	16	0033.4032
100	110	230	0033.4040
115	0	230	0033.4044
230	240	250	0033.4049
115 V	230 V	240 V	0033.4055
1	2	3	0033.4056
100	120	230-240	0033.4057
110		230	0033.4062

Most Popular.

Availability for all products can be searched real-time: <https://www.schurter.com/en/Stock-Check/Stock-Check-SCHURTER>

Packaging Unit 50 Pcs